

FDV

Multi COB Quick Direct 6,5W

El nr	32 005 04
Article nr	110504
EAN	7090015371212



Lysteknikk

Type lyskilde	LED (Sunpu COB LED)
Spenning	230VAC 50/60Hz
Watt	5,25W
Systemeffekt (W)	6,5W
Effektiv lysstrøm (lm)	550 lm
Effekt	86lm/W
Fargetemperatur	2700K
Fargegjengivelse (CRI)	Ra>80
MacAdams faktor	SDCM<3
Levetid	62000 L80
Lysspredning	60°

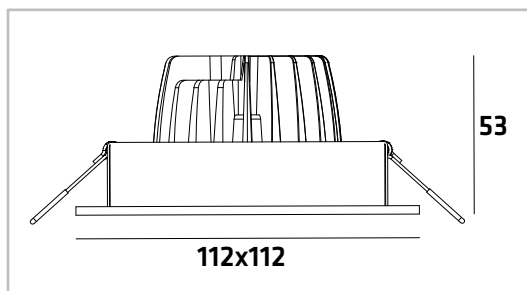
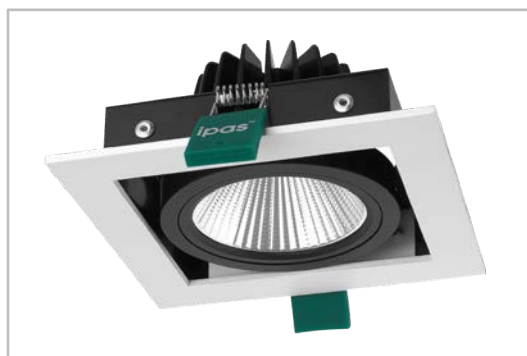

Dimmetype

Type	Dimbar faseavsnitt
------	--------------------

Beskyttelse

Isolasjonsklasse	Klasse II
IP-grad (armaturhus)	IP44

Materialer og overflater

Armaturhus	Aluminium die-cast
Farge	Matt hvit (RAL 9010)
Optikk/Reflektor	Glass/Alu

Energi og godkjenning

Energiklasse	A-A++
Godkjenning	CE, RoHS
Safety standard	EN 61347-2-13:2014+AMD1:2017, EN 6134701:2015
EMC standard	EN 55015:2013+A1:2015, EN 61547:2009, EN 61000-3-2:2014, EN 61000-3-3:2013

Montering/Tilkobling

Montering	Innfelling
Kobling	Hurtigklemme

Dimensjoner (mm)

Lengde (L)	112 mm
Bredde (W)	112 mm
Høyde (H)	53 mm
Innfellingsdiameter	97x97 mm
Vekt	0,32 kgs

Forpakning

Eske dimensjon	140x130x80 mm
Eske Vekt	0,35 kgs
Kartong Dimensjon	540x440x190 mm
Antall/Kartong	24 stk
Kartong Vekt	10,5 kgs

Multi Quick Direct

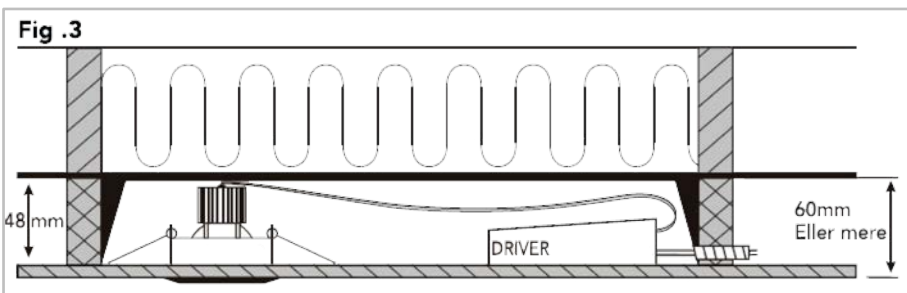
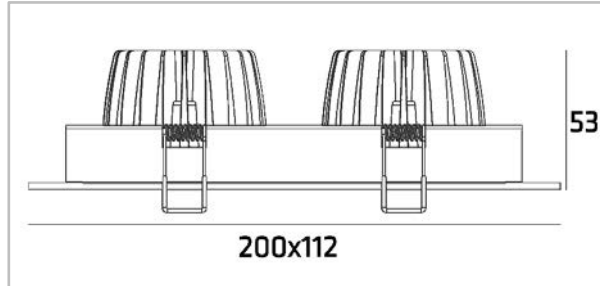
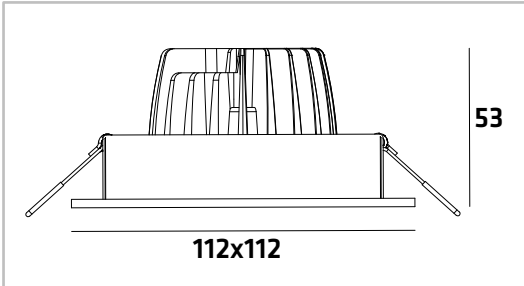
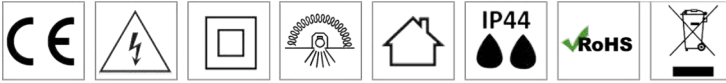

IMPORTANT INFORMATION:

1. Please read this instruction carefully before installation and keep it for future reference.
2. Please conform to the instruction of equipment and installed by professional.
3. Make sure correct voltage applied before use and keep away from heat and vibration source.
4. The light source of this luminaire is not replaceable. When the light source reaches its end of life the whole luminaire shall be replaced.
5. The product is not suitable for any oil pollution ambient or related applications.
6. For indoor use only.

MAIN PARAMETER:

Product	110504	111004
Rated Voltage	AC 220-240V 50/60Hz	AC 220-240V 50/60Hz
LED watt	5,25W	2x5,25W
System eff	6,5W	2x6,5W
LED	Sunpu COB LED	Sunpu COB LED
LED Driver	Constant Current 350mA	Constant Current 350mA
Color Temperature	2700K	2700K
Protection	Class II	Class II
Beam Angle	60°	60°
IP Rated	IP20	IP20
Operation Temperature	-25°C <ta<45°C	-25°C <ta<45°C
Cut-out	97x97mm	187x97mm
Product Size	112mmx112mmx53mm	200mmx112mmx53mm

INSTALLATION INSTRUCTIONS:

1. Always switch off the power supply before installation.
2. Make sure all parts are ready when open the box and prepare the installation tools the lighting needs.
3. Should be installed by qualified electricians.
4. If there is any damage on the housing or glass cover, should view it as disqualified product that cannot be used.
5. If the external flexible cable or cord of this luminaire is damaged, it shall be exclusively replaced by the manufacturer or his service agent or a similar qualified person in order to avoid a hazard.

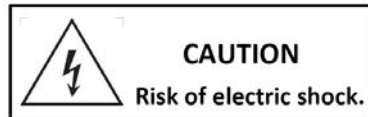
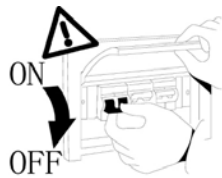

INSTALLATION STEPS:

1. Cut-out for the downlight.

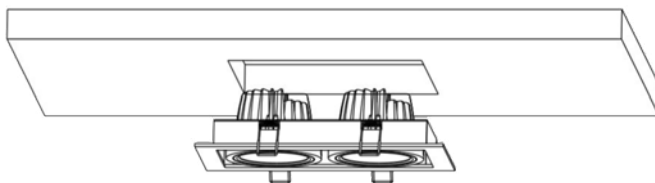

Article nr	Cut-Out
110504	97x97mm
111004	187x97 mm

2. Connect Mains supply to the quick connection terminal block of LED driver. Slide the mounting spring clips into the ceiling cut-out hole and push the luminaire up into cutting hole. Ensure that it is securely located.

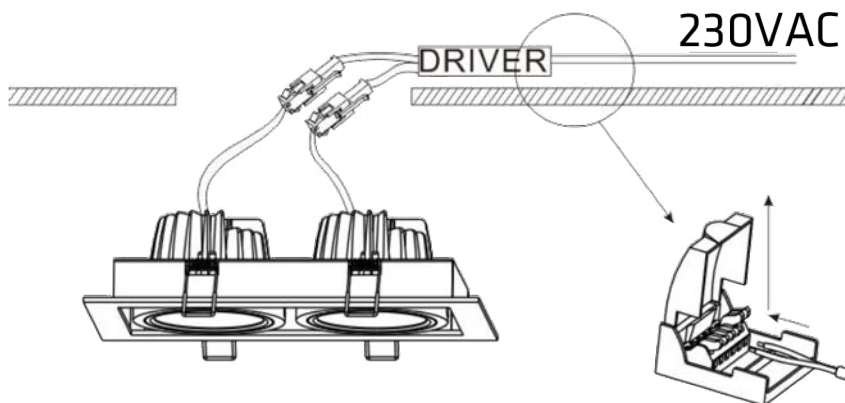

3. Switch on the power supply.

