

PRODUKTDATABLAD

DL COMFORT DN 205 20 W 3CCT IP54 WT

DOWNLIGHT COMFORT | Downlights med justerbare hvite lysfarger



Bruksområder

- Direkte erstatning for armaturer med kompakt lysrør
- Generell belysning
- Baderom, kjøkken og overbygde uteområder
- Kontorer
- Korridorer
- Foajeer
- Butikker
- Trapp ganger

Produktfunksjoner

- Tre lysfarger kan velges ved hjelp av glibryter
- Beskyttelsesgrad: IP54
- Kontaktboks med ledningsterminal som kan kobles sammen uten verktøy
- Gjennomgangskabling mulig



TEKNISKE DATA

ELEKTRISK INFORMASJON

Nominell effekt	20,00 W
Nominell spenning	100...277 V
Nettfrekvensen	50...60 Hz
Nominell strøm	230 mA
Startstrøm	50 A
Startsstrøm tid T_{h50}	100 μ s
Maks. armaturer på automatsikring, B16 A	13
Maks. armaturer på automatsikring, C10 A	10
Maks. armaturer på automatsikring, C16 A	17
Effektfaktor λ	> 0,90
Total harmonisk forvrengning	< 20 %
Beskyttelsesklasse	I
Driftsmodus	Integrated LED driver

Fotometriske filer

Lysstrøm	1720...1930 lm ¹⁾
Lysutbytte	90 lm/W ²⁾
Fargetemperatur	3000...5700 K
Lysfarge (betegnelse)	Varmhvit / Kjølig hvit / Kjølig dagslys
Fargegjengivelsesindeks Ra	> 80
Standardavvik av fargeavstemning	< 5 sdcm
Lysstyrke	-
Flimerverdi (Pst LM)	-
Stroposkop effektverdi (SVM)	-
Fotobiologisk sikkerhetsgruppe i EN62778	RG0
Fotobiologisk sikkerhetsgruppe i EN62471	RG0
Utstrålingsvinkel	60 °
UGR longitudinal	ikke relevant

¹⁾ Luminous flux dependent on selected color temperature: 1720 lm@3000 K/1930 lm@4000 K/1810 lm@5700 K

²⁾ Value at 5700 K, different for other color temperatures

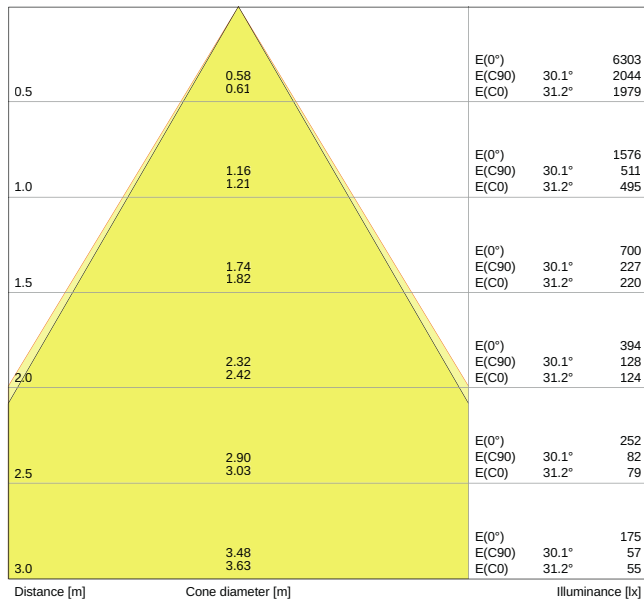

LDC typ cone

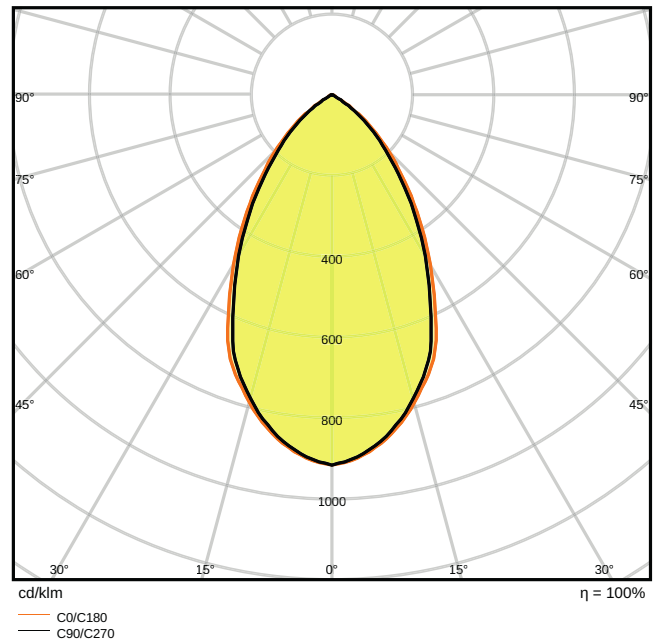

LDC typ polar

DIMENSJONER & VEKT

Diameter	228,00 mm
Høyde	98,00 mm
Produktvekt	550,00 g

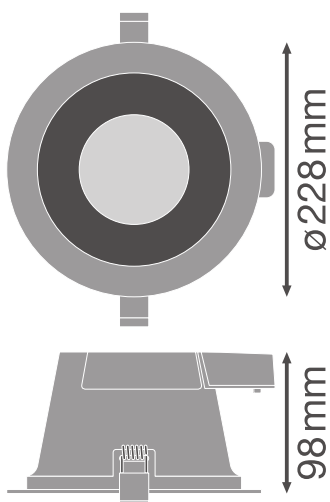

MATERIALER & FARGER

Produktfarge	Hvit
Farge på deksel	Hvit
Materiale	Aluminum
Kapslingsmateriale	Polymethylmethacrylate (PMMA)
Glødetrådtest henhold til IEC 60695-2-12	650 °C
Lyskildens kvikksølvinnhold	0.0 mg

BRUK & MONTERING

Omgivelsestemperatur-område	-20...+45 °C
Type tilkobling	Skrueløs terminal, 2 polet
Beskyttelses type	IP54/IP20
Beskyttelsesklasse IK (sjokk motst [PIM])	IK03
Dimmable	No
Monteringstype	Recessed
Monteringsplassering	Tak
Monteringsdiameter	205 mm
Monteringsdybde	125 mm
Utskiftbar LED modul	Kan ikke byttes

Levetid

Levetid L70/B50 @ 25 °C	50000 h
Levetid L80/B10 @ 25 °C	43000 h
Levetid L90/B10 @ 25 °C	30000 h
Antall tenn sykluser	50000











CERTIFIKATER & STANDARDER

Standarder	CE / CB / ENEC / TÜV SÜD
Begrenset overflatetemperatur	Nei
Ballskuddsikker	Nei

NEDLASTNINGER



NEDLASTNINGER

	User instruction UI Downlight Comfort
	Tender documents Tender Text 4058075104105
	Declarations of conformity EU Declaration of Conformity DOWNLIGHT Comfort LEDV
	Declarations of conformity Attestation-of-Conformity DOWNLIGHT Comfort TÜV
	On-Pack-Info Legal Insert Downlight LED ALU+Comfort
	IES file (IES) DL COMFORT DN205 20W3CCT 60DEG WT-3000K
	LDT file (Eulumdat) DL COMFORT DN205 20W3CCT 60DEG WT-3000K
	R3D file (Relux 3D Model) Downlight comfort 205
	M3D file (3D Model) Downlight_Comfort_205
	ULD file (DIALux) DL COMFORT DN205
	UGR file (UGR table) DL COMFORT DN205 20W3CCT 60DEG WT-3000K

LOGISTIKK INFORMASJON

Produktkode	Forpakkings enhet (stk/enhet)	Dimensjoner (lengde x bredde x høyde)	Bruttovekt	Volum
4058075104105	Folding box 1	250 mm x 250 mm x 140 mm	667.00 g	8.75 dm ³
4058075104112	Shipping box 8	520 mm x 520 mm x 300 mm	7350.00 g	81.12 dm ³

The mentioned product code describes the smallest quantity unit which can be ordered. One shipping unit can contain one or more single products. When placing an order, for the quantity please enter single or multiples of a shipping unit.

YTTERLIGERE KATALOG INFORMASJON

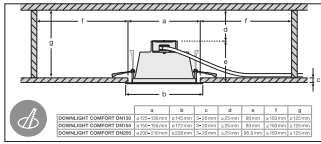
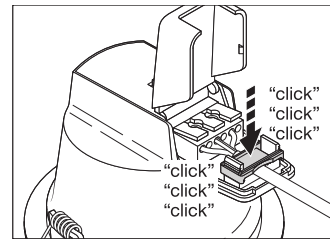
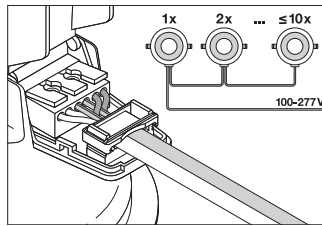
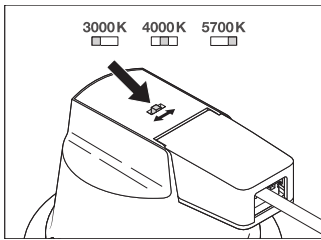

Referanser / Linker

- For garanti se www.ledvance.no/garanti

ANSVARFRASKRIVELSE

Endres uten varsel. Sørg alltid for å bruke den nyeste versjonen.