





Circuit-breaker, 4 pole, 1000A, 66 kA, Selective operation, IEC, Fixed



Part no. IZMX40B4-V10F-1  
 Catalog No. 183895

EL-Nummer (Norway) 4398305

**Delivery program**

Product range			Air circuit-breakers/switch-disconnectors
Product range			Open circuit-breakers
Current Range			Up to 4000 A
Protective function			Selective operation
Installation type			Fixed
			Main terminals must be separately ordered.
Construction size			IZMX40
Release system			Electronic release
Standard/Approval			IEC
Number of poles			4 pole
Degree of Protection			IP31 with door seals, IP55 with protective cover suitable for zone selectivity optionally fittable by user with comprehensive accessories
Rated current = rated uninterrupted current	$I_n = I_u$	A	1000
up to 440 V 50/60 Hz	$I_{cu}$	kA	66
up to 440 V 50/60 Hz	$I_{cs}$	kA	66
Overload release, min.	$I_r$	A	400
Overload release, max.	$I_r$	A	1000
Non-delayed	$I_l = I_n \times \dots$		2 - 15, OFF
			
Delayed	$I_{sd} = I_r \times \dots$		1,5 - 10
			

**Technical data**

**General**

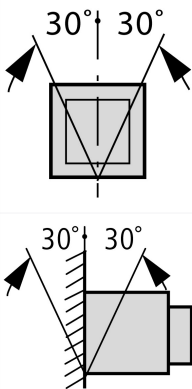
Standards			IEC/EN 60947
Ambient temperature			
Storage	$\theta$	°C	-20 - +70
Ambient temperature		°C	-20 - +70
Mounting position			
Utilization category			B
Degree of Protection			IP31 with door seals, IP55 with protective cover
Direction of incoming supply			as required

**Main conducting paths**

Rated current = rated uninterrupted current	$I_n = I_u$	A	1000
---	-------------	---	------

Rated uninterrupted current at 50 °C	$I_u$	A	1000
Rated uninterrupted current at 60 °C	$I_u$	A	1000
Rated uninterrupted current at 70 °C	$I_u$	A	1000
Rated impulse withstand voltage	$U_{imp}$	V AC	12000
Rated operational voltage	$U_e$	V AC	690
Use in IT electrical power networks up to	U	V	440
Overvoltage category/pollution degree			III/3
Rated insulation voltage	$U_i$	V	1000

### Switching capacity

Rated short-circuit making capacity	$I_{cm}$		
up to 440 V 50/60 Hz	$I_{cm}$	kA	145
up to 690 V 50/60 Hz	$I_{cm}$	kA	145
Rated short-time withstand current 50/60 Hz			
t = 1 s	$I_{cw}$	kA	66
t = 3 s	$I_{cw}$	kA	53
Rated short-circuit breaking capacity $I_{cn}$	$I_{cn}$		
IEC/EN 60947 operating sequence $I_{cu}$ 0-t-CO			
up to 240 V 50/60 Hz	$I_{cu}$	kA	66
up to 440 V 50/60 Hz	$I_{cu}$	kA	66
up to 690 V 50/60 Hz	$I_{cu}$	kA	66
IEC/EN 60947 operating sequence $I_{cs}$ 0-t-CO-t-CO			
up to 240 V 50/60 Hz	$I_{cs}$	kA	66
up to 440 V 50/60 Hz	$I_{cs}$	kA	66
up to 690 V 50/60 Hz	$I_{cs}$	kA	66
Operating times			
Closing delay via spring release		ms	35
Total opening delay via shunt release		ms	35
Total opening delay via undervoltage release		ms	40
Total opening delay on non-delayed short-circuit release (up to complete arc quenching)		ms	52
Lifespan		S	
Lifespan, mechanical	Switching cycles (ON/OFF)		12500
Lifespan, mechanical with maintenance	Switching cycles (ON/OFF)		25000
Lifespan, electrical	Switching cycles (ON/OFF)		10000
Lifespan, electrical with maintenance	Switching cycles (ON/OFF)		20000
Maximum operating frequency	Operations/h		60
Heat dissipation at rated current $I_n$			
Fixed mounting		W	55

### Weight

Fixed mounting			
4-pole		kg	56

### Terminal capacities

Copper bar			
Fixed mounting			
Black		mm	1 x 60 x 10
These are values used in separate switchgear. The actual values will depend on the temperature around the circuit-breaker, which is influenced by the ambient temperature, the degree of protection (IP), the mounting height, the partitions, and any external ventilation. Depending on the specific switchgear design, this may result in derating, which can then be compensated for by increasing the cross-			

		sectional area. Temperature rise tests in the specific switchgear can provide specific and detailed information.
		Permissible continuous current for circuit-breakers operating in switchboards at various internal ambient temperatures. The switchboard's internal ambient temperature should be estimated using the calculation methods of IEC regulation.

## Design verification as per IEC/EN 61439

Technical data for design verification			
Rated operational current for specified heat dissipation	$I_n$	A	1000
Equipment heat dissipation, current-dependent	$P_{vid}$	W	55
Operating ambient temperature min.		°C	-20
Operating ambient temperature max.		°C	70
IEC/EN 61439 design verification			
10.2 Strength of materials and parts			
10.2.2 Corrosion resistance			Meets the product standard's requirements.
10.2.3.1 Verification of thermal stability of enclosures			Meets the product standard's requirements.
10.2.3.2 Verification of resistance of insulating materials to normal heat			Meets the product standard's requirements.
10.2.3.3 Verification of resistance of insulating materials to abnormal heat and fire due to internal electric effects			Meets the product standard's requirements.
10.2.4 Resistance to ultra-violet (UV) radiation			Meets the product standard's requirements.
10.2.5 Lifting			Does not apply, since the entire switchgear needs to be evaluated.
10.2.6 Mechanical impact			Does not apply, since the entire switchgear needs to be evaluated.
10.2.7 Inscriptions			Meets the product standard's requirements.
10.3 Degree of protection of ASSEMBLIES			Does not apply, since the entire switchgear needs to be evaluated.
10.4 Clearances and creepage distances			Meets the product standard's requirements.
10.5 Protection against electric shock			Does not apply, since the entire switchgear needs to be evaluated.
10.6 Incorporation of switching devices and components			Does not apply, since the entire switchgear needs to be evaluated.
10.7 Internal electrical circuits and connections			Is the panel builder's responsibility.
10.8 Connections for external conductors			Is the panel builder's responsibility.
10.9 Insulation properties			
10.9.2 Power-frequency electric strength			Is the panel builder's responsibility.
10.9.3 Impulse withstand voltage			Is the panel builder's responsibility.
10.9.4 Testing of enclosures made of insulating material			Is the panel builder's responsibility.
10.10 Temperature rise			The panel builder is responsible for the temperature rise calculation. Eaton will provide heat dissipation data for the devices.
10.11 Short-circuit rating			Is the panel builder's responsibility. The specifications for the switchgear must be observed.
10.12 Electromagnetic compatibility			Is the panel builder's responsibility. The specifications for the switchgear must be observed.
10.13 Mechanical function			The device meets the requirements, provided the information in the instruction leaflet (IL) is observed.

## Technical data ETIM 7.0

Low-voltage industrial components (EG000017) / Power circuit-breaker for trafo/generator/installation protection (EC000228)			
Electric engineering, automation, process control engineering / Low-voltage switch technology / Circuit breaker (LV < 1 kV) / Circuit breaker for power transformer, generator and system protection (ecl@ss10.0.1-27-37-04-09 [AJZ716013])			
Rated permanent current $I_u$		A	1000
Rated voltage		V	690 - 690
Rated short-circuit breaking capacity $I_{cu}$ at 400 V, 50 Hz		kA	66
Overload release current setting		A	400 - 1000
Adjustment range short-term delayed short-circuit release		A	600 - 10000
Adjustment range undelayed short-circuit release		A	2000 - 15000
Integrated earth fault protection			No
Type of electrical connection of main circuit			Rail connection
Device construction			Built-in device fixed built-in technique
Suitable for DIN rail (top hat rail) mounting			No
DIN rail (top hat rail) mounting optional			No
Number of auxiliary contacts as normally closed contact			0
Number of auxiliary contacts as normally open contact			0

Number of auxiliary contacts as change-over contact		2
With switched-off indicator		Yes
With under voltage release		No
Number of poles		4
Position of connection for main current circuit		Back side
Type of control element		Push button
Complete device with protection unit		Yes
Motor drive integrated		No
Motor drive optional		Yes
Degree of protection (IP)		IP31

## Dimensions

