

PLC-RPT- 48DC/21 - Relemodul



2900301

El-nr.: 4300195

<https://www.phoenixcontact.com/no/produkter/2900301>

Vær oppmerksom på at dataene som er angitt i dette PDF-dokumentet genereres fra vår onlinekatalog. Du finner komplette data i brukerdokumentasjonen. De generelle bruksvilkårene for nedlastinger fra Internett gjelder.



PLC-INTERFACE, består av basismodul PLC-BPT.../21 med Push-in-tilkobling og pluggbart miniatyrrelé med effektkontakt, monteres på monteringsskinne NS 35/7,5, én vekselkontakt, inngangsspenning 48 V DC

Dine fordeler

- Smal byggform
- Effektiv implementering i systemkablingen med V8-adapter
- Sikker skille mellom spole- og kontaktside
- RT-III tette releer
- Funksjonelle lasker
- Integrert inngangs- og støydempingskobling

Forretningsinformasjon

| | |
|-----------------------------------|---------------------|
| Artikkelnummer | 2900301 |
| Pakkestørrelse | 10 Stk. |
| Minimum bestillingsmengde | 1 Stk. |
| Rabattgruppe | 31BC62 |
| Produktnøkkel | CK623A |
| Katalogside | Side 364 (C-5-2019) |
| GTIN | 4046356507141 |
| Vekt pr. stk. (inkl. forpakning) | 35,604 g |
| Vekt pr. stk. (ekskl. forpakning) | 32,069 g |
| Tolltariffnummer | 85364190 |
| Opprinnelsesland | DE |

2900301

El-nr.: 4300195

<https://www.phoenixcontact.com/no/produkter/2900301>

Tekniske spesifikasjoner

Artikkelegenskaper

| | |
|------------------|-----------------------------------|
| Produkttype | Relemodul |
| Produktserie | PLC-INTERFACE |
| Anvendelse | Universell |
| Driftstype | 100 % ED |
| Levetid mekanisk | 2x 10 ⁷ koblingsforløp |

Elektriske egenskaper

| | |
|-----------------------------------------------|------------------------------------------|
| Maksimalt effekttap ved nominelle betingelser | 0,44 W |
| Prøvespenning (Vikling/kontakt) | 4 kV AC (50 Hz, 1 min., vikling/kontakt) |

Isolasjonsegenskaper: Spole/kontakt

| | |
|---------------------------|-------|
| Merkeisolasjonsspenning | 250 V |
| Merkestøtspenningsfasthet | 6 kV |
| Overspenningskategori | III |
| Forurensningsgrad | 3 |

Inngangsdata

Spoleside

| | |
|---------------------------------|----------------------------------------------------------------------------------------------|
| Nominell inngangsspenning U_N | 48 V DC |
| Inngangsspenningsområde | 37,4 V DC ... 60 V DC (20 °C) |
| Drivenhetens koblingsegenskaper | monostabil |
| Drivenhet (polaritet) | polarisert |
| Typisk inngangsstrøm ved U_N | 9,2 mA |
| Typisk reaksjonstid | 5 ms |
| Typisk løsetid | 8 ms |
| Beskyttelseskobling | Polaritetsbeskyttelse; Polaritetsbeskyttelsesdiode Overspenningsbeskyttelse; Friløpsdiode |
| Driftsspenningsindikator | ja |

Utgangsdata

Koble

| | |
|------------------------|---------------------------------------------------------------------------------------------------------------------------------------------------------------------------------------------------|
| Kontaktutførelse | 1 vekselkontakt |
| Type koblingskontakt | Enkeltkontakt |
| Kontaktmaterial | AgSnO |
| Maks. koblingsspenning | 250 V AC/DC (Ved spenninger over 250 V (L1, L2, L3) mellom like klemmer til nabomoduler skal skilleplaten PLC-ATP monteres. Potensialbrokobling foretas da med FBST 8-PLC... eller...FBST 500...) |
| Min. koblingsspenning | 5 V (100 mA) |
| Varig grensestrøm | 6 A |

PLC-RPT- 48DC/21 - Relemodul



2900301

El-nr.: 4300195

<https://www.phoenixcontact.com/no/produkter/2900301>

| | |
|-------------------------------------|-------------------------------------|
| Maks. innkoblingsstrøm | 10 A (4 s) |
| Min. koblingsstrøm | 10 mA (12 V) |
| Kortslutningsstrøm | 200 A (betinget kortslutningsstrøm) |
| Utkoblingseffekt (ohmsk last) maks. | 140 W (ved 24 V DC) |
| | 20 W (ved 48 V DC) |
| | 18 W (ved 60 V DC) |
| | 23 W (ved 110 V DC) |
| | 40 W (ved 220 V DC) |
| | 1500 VA (ved 250 V AC) |
| Utgangssikring | 4 A gL/gG NEOZED |
| Koblingskapasitet | 2 A (ved 24 V, DC13) |
| | 0,2 A (ved 110 V, DC13) |
| | 0,1 A (ved 220 V, DC13) |
| | 3 A (ved 24 V, AC15) |
| | 3 A (ved 120 V, AC15) |
| | 3 A (ved 230 V, AC15) |

Tilkoblingsdata

| | |
|----------------------------|----------------------------------------------------------------|
| Tilkoblingstype | Innstikkstilkobling |
| Avisoleringslengde | 10 mm |
| Ledertverrsnitt entrådet | 0,14 mm ² ... 2,5 mm ² |
| Ledertverrsnitt flertrådet | 0,14 mm ² ... 2,5 mm ² |
| | 0,2 mm ² ... 2,5 mm ² (Enkeltendehylse) |
| | 2x 0,5 mm ² ... 1 mm ² (TWIN-ende-hylse) |
| Ledertverrsnitt AWG | 26 ... 14 |

Dimensjoner

| | |
|--------|--------|
| Bredde | 6,2 mm |
| Høyde | 80 mm |
| Dybde | 94 mm |

Materialangivelser

| | |
|-------------------------------|----------|
| Brennbarhetsklasse iht. UL 94 | V0 (Hus) |
|-------------------------------|----------|

Miljø- og levetidsbetingelser

Miljøforhold

| | |
|------------------------------------------|-------------------|
| Beskyttelsesgrad (Relé) | RT III (Relé) |
| Beskyttelsesgrad (Relesokkel) | IP20 (Relesokkel) |
| Omgivelsestemperatur (drift) | -40 °C ... 60 °C |
| Omgivelsestemperatur (lagring/transport) | -40 °C ... 85 °C |

Godkjenninger

PLC-RPT- 48DC/21 - Relemodul



2900301

El-nr.: 4300195

<https://www.phoenixcontact.com/no/produkter/2900301>

CE

| | |
|------------|------------|
| Sertifikat | CE-samsvar |
|------------|------------|

UKCA

| | |
|------------|--------------|
| Sertifikat | UKCA-samsvar |
|------------|--------------|

Godkjenning for skipsbygging

| | |
|------------|------------|
| Sertifikat | TAE0000196 |
|------------|------------|

Test for skadelig gass

| | |
|---------|----------------------------|
| Merking | ISA-S71.04. G3 Harsh Group |
| | EN 60068-2-60 |

DNV GL-data

| | |
|-------------|-----------------------------------------------------------------------------------------|
| Temperature | D |
| Humidity | A |
| Vibration | B/C |
| EMC | B |
| Enclosure | Required protection according to the Rules shall be provided upon installation on board |

EMC-data

| | |
|---------------------------------|-----------------------------------|
| Lavspenningsdirektiv | I samsvar med NS-direktiv |
| Elektromagnetisk kompatibilitet | Overensstemmelse med EMC-direktiv |

Standarder og bestemmelser

| | |
|-------------------------|---------------|
| Standarder/bestemmelser | IEC 60947-5-1 |
|-------------------------|---------------|

Montering

| | |
|-----------------------|---------------------------------|
| Monteringstype | Skinnemontering |
| Monteringsinformasjon | kan rekkeklasseres uten avstand |
| Innbygning | vilkårlig |

2900301

El-nr.: 4300195

<https://www.phoenixcontact.com/no/produkter/2900301>

Tegninger

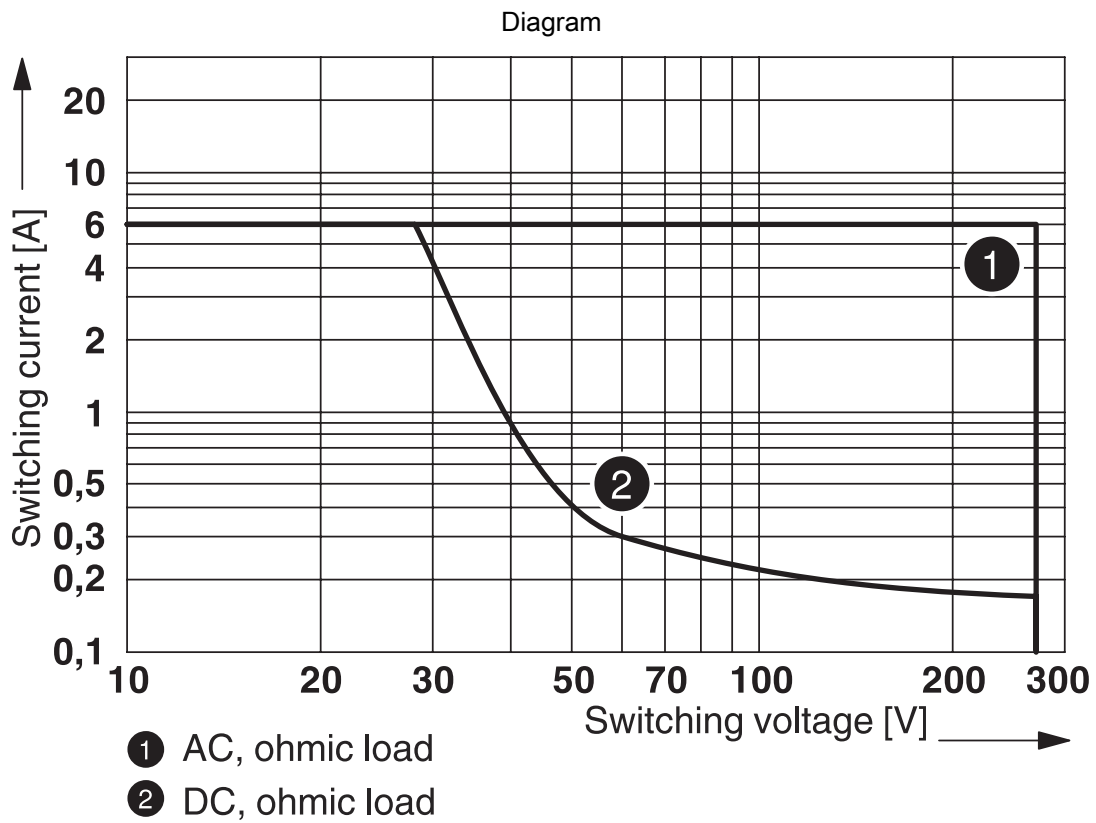

Utkoblingseffekt

Diagram

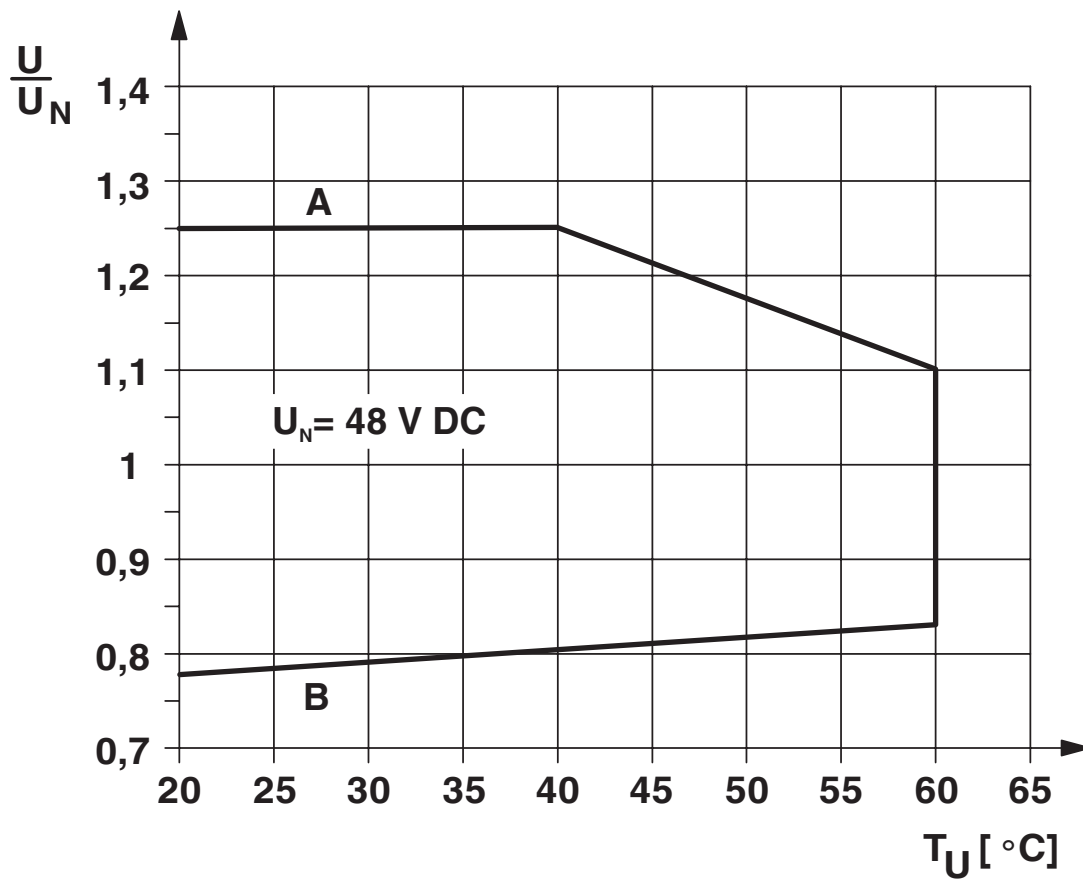

Kurve A

Maksimalt tillatt varig spenning U_{maks} ved varig grensestrøm på kontaktsiden (se tilhørende tekniske data)

Kurve B

Minimalt tillatt driftsspenning U_{drift} etter formagnetisering (se tilhørende tekniske data)

2900301

El-nr.: 4300195

<https://www.phoenixcontact.com/no/produkter/2900301>

Diagram

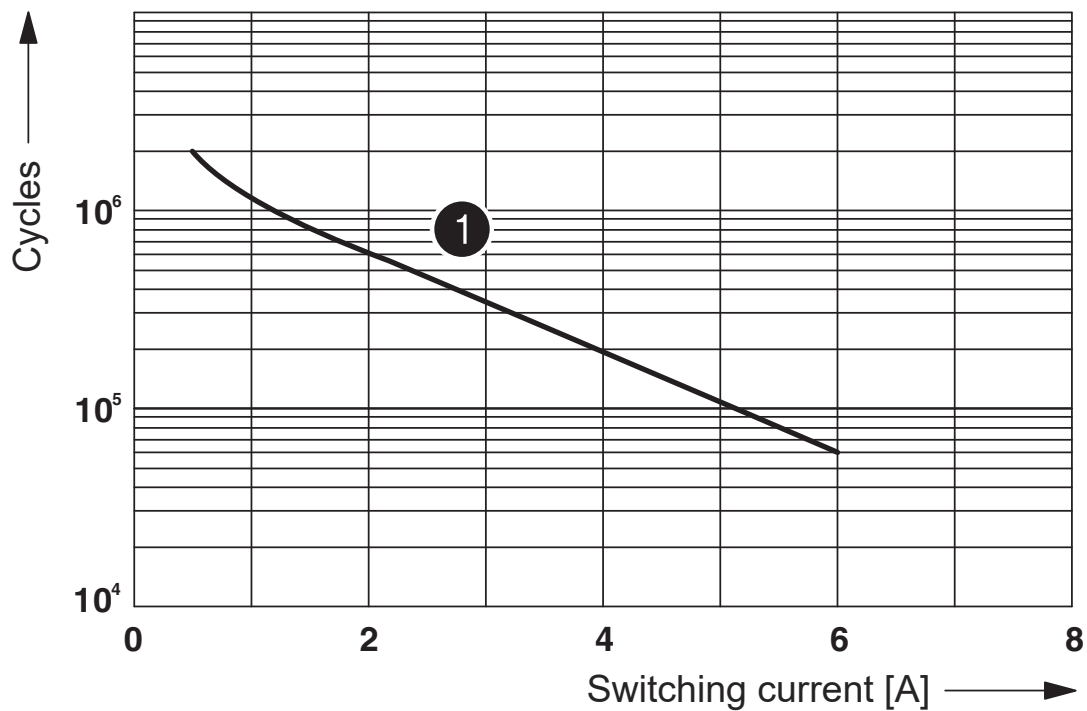

① 250 V AC, ohmic load

Elektrisk levetid

2900301

El-nr.: 4300195

<https://www.phoenixcontact.com/no/produkter/2900301>

Diagram

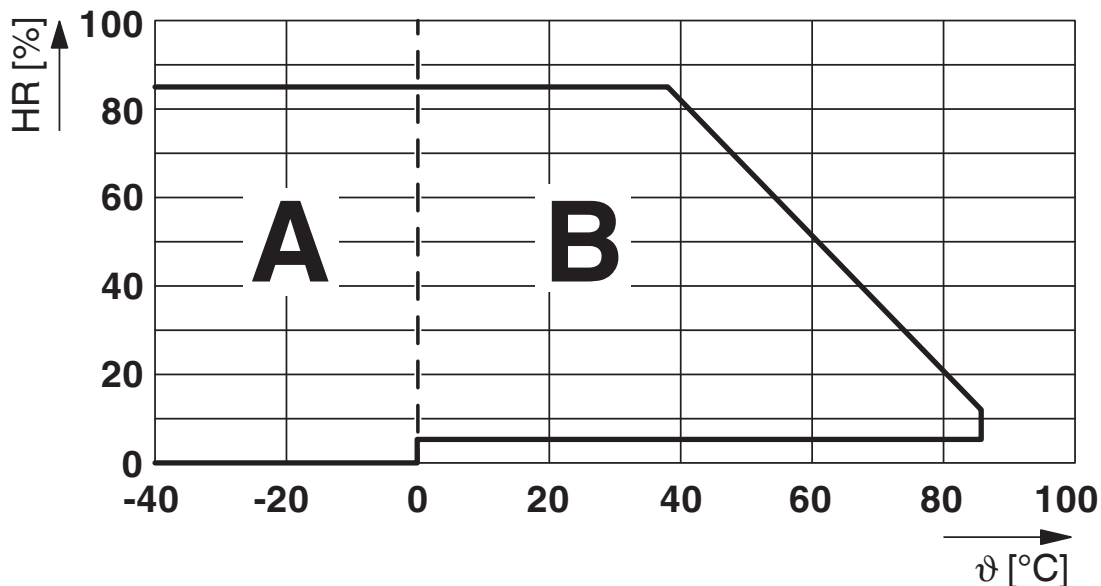

Tillatt luftfuktighet for drift og lagring.

Overhold den maksimalt tillatte omgivelsestemperaturen i henhold til databladet.

Område A: Ising ved omgivelsestemperaturer $\leq 0\text{ °C}$ må forhindres

Område B: Kondens ved omgivelsestemperaturer $> 0\text{ °C}$ må forhindres

På 30 hele dager, selvfølgelig fordelt utover året, er det ved en omgivelsestemperatur på $\leq 25\text{ °C}$ tillatt med en luftfuktighet på 95 %.

Koblingsskjema

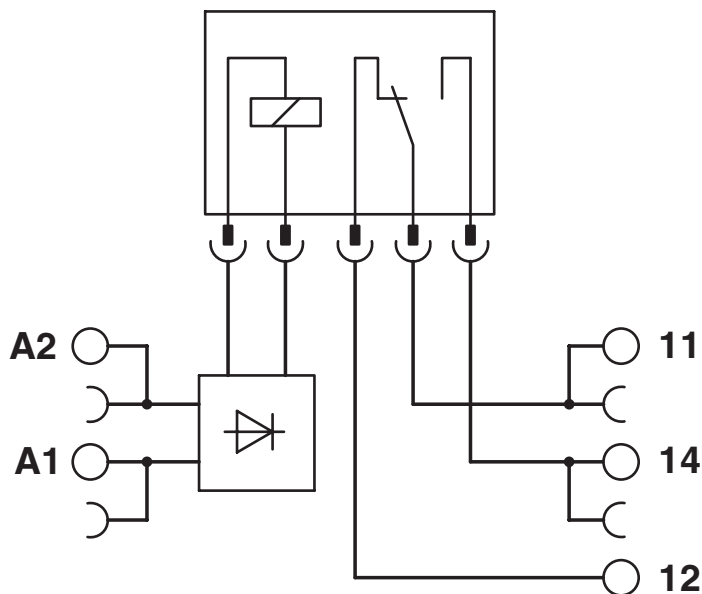

2900301

El-nr.: 4300195

<https://www.phoenixcontact.com/no/produkter/2900301>

Godkjenninger

🔗 To download certificates, visit the product detail page: <https://www.phoenixcontact.com/no/produkter/2900301>



cUL Recognized

Godkjennings-ID: FILE E 238705



UL Recognized

Godkjennings-ID: FILE E 238705



EAC

Godkjennings-ID: TR_TS_D_00573_c



DNV GL

Godkjennings-ID: TAE0000196



UL Listed

Godkjennings-ID: FILE E 172140



cUL Listed

Godkjennings-ID: FILE E 172140

cULus Recognized

cULus Listed

2900301

EI-nr.: 4300195

<https://www.phoenixcontact.com/no/produkter/2900301>

Klassifiseringer

ECLASS

| | |
|-------------|----------|
| ECLASS-11.0 | 27371601 |
| ECLASS-12.0 | 27371601 |
| ECLASS-13.0 | 27371601 |

ETIM

| | |
|----------|----------|
| ETIM 9.0 | EC001437 |
|----------|----------|

UNSPSC

| | |
|-------------|----------|
| UNSPSC 21.0 | 39122300 |
|-------------|----------|

PLC-RPT- 48DC/21 - Relemodul



2900301

EI-nr.: 4300195

<https://www.phoenixcontact.com/no/produkter/2900301>

Environmental product compliance

| | |
|------------|------------------------------------------------------------------------------------|
| REACH SVHC | Lead 7439-92-1 |
| | Hexahydromethylphthalic anhydride |
| China RoHS | Tidsrom for forskriftsmessig bruk (EFUP): 50 år |
| | Du finner informasjon om farlige substanser i produsenterklæringen, se "Downloads" |

PLC-RPT- 48DC/21 - Relemodul

2900301

El-nr.: 4300195

<https://www.phoenixcontact.com/no/produkter/2900301>

Tilbehør

 Merk: Bruk av enkelte av tilbehørsdelene som er oppført nedenfor, kan begrense produktet.

FBST 500-PLC RD - Sammenhengende lask

2966786

<https://www.phoenixcontact.com/no/produkter/2966786>



Sammenhengende lask, lengde: 500 mm, farge: rød

 Maks. strømbelastning: 32 A

FBST 500-PLC BU - Sammenhengende lask

2966692

<https://www.phoenixcontact.com/no/produkter/2966692>

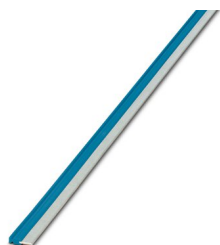

Sammenhengende lask, lengde: 500 mm, farge: blå

 Maks. strømbelastning: 32 A

PLC-RPT- 48DC/21 - Relemodul

2900301

El-nr.: 4300195

<https://www.phoenixcontact.com/no/produkter/2900301>



FBST 500-PLC GY - Sammenhengende lask

2966838

<https://www.phoenixcontact.com/no/produkter/2966838>



Sammenhengende lask, lengde: 500 mm, farge: grå

 Maks. strømbelastning: 32 A

FBST 6-PLC RD - Enkeltlask

2966236

<https://www.phoenixcontact.com/no/produkter/2966236>

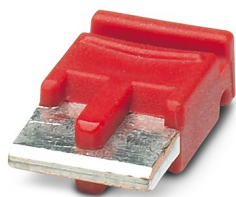

Enkeltlask, poltall: 2, lengde: 6 mm, farge: rød

 Maks. strømbelastning: 6 A

PLC-RPT- 48DC/21 - Relemodul

2900301

El-nr.: 4300195

<https://www.phoenixcontact.com/no/produkter/2900301>





FBST 6-PLC BU - Enkeltlask

2966812

<https://www.phoenixcontact.com/no/produkter/2966812>

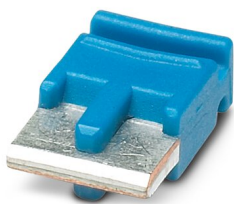
Enkeltlask, poltall: 2, lengde: 6 mm, farge: blå



 Maks. strømbelastning: 6 A

FBST 6-PLC GY - Enkeltlask

2966825

<https://www.phoenixcontact.com/no/produkter/2966825>

Enkeltlask, poltall: 2, lengde: 6 mm, farge: grå

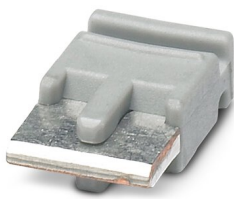

 Maks. strømbelastning: 6 A

PLC-RPT- 48DC/21 - Relemodul

2900301

El-nr.: 4300195

<https://www.phoenixcontact.com/no/produkter/2900301>



FBST 8-PLC GY - Enkeltlask

2967688

<https://www.phoenixcontact.com/no/produkter/2967688>

Enkeltlask, poltall: 2, lengde: 8 mm, farge: grå



 Maks. strømbelastning: 6 A

PLC-FA-5X20 - Sikringsadapter

1186510

<https://www.phoenixcontact.com/no/produkter/1186510>



Sikringspluggadapter, brukes på en 6,2 mm PLC-basisklemme. Til smeltesikringer 5 x 20 mm. Driftsspenning: universell. Uten indikator for defekte sikringer.

PLC-RPT- 48DC/21 - Relemodul

2900301

El-nr.: 4300195

<https://www.phoenixcontact.com/no/produkter/2900301>



PLC-FA-I-5X20-12-24UC - Sikringsadapter

1186499

<https://www.phoenixcontact.com/no/produkter/1186499>



Sikringspluggadapter, brukes på en 6,2 mm PLC-basisklemme. Til smeltesikringer 5 x 20 mm. Driftsspennning: 12 ... 24 V AC/DC. Med LED som indikator for defekte sikringer.

PLC-FA-I-5X20-120-230UC - Sikringsadapter

1186508

<https://www.phoenixcontact.com/no/produkter/1186508>



Sikringspluggadapter, brukes på en 6,2 mm PLC-basisklemme. Til smeltesikringer 5 x 20 mm. Driftsspennning: 120 ... 230 V AC/DC. Med LED som indikator for defekte sikringer.

PLC-RPT- 48DC/21 - Relemodul

2900301

El-nr.: 4300195

<https://www.phoenixcontact.com/no/produkter/2900301>



ZB 6:UNBEDRUCKT - Merkeremse

1051003

<https://www.phoenixcontact.com/no/produkter/1051003>



Merkeremse, Strimmel, hvit, uten merking, kan merkes med: PLOTMARK, CMS-P1-PLOTTER, monteringsstype: feste, for klemmebredde: 6,2 mm, tekstfeltstørrelse: 6,15 x 10,5 mm, Antall enkeltskilt: 10

ZB 6 CUS - Merkeremse

0824992

<https://www.phoenixcontact.com/no/produkter/0824992>



Merkeremse, kan bestilles: i form av strimler, hvit, merket etter kundespesifikasjoner, monteringsstype: feste i høyt skiltspor, for klemmebredde: 6,2 mm, tekstfeltstørrelse: 6,15 x 10,5 mm, Antall enkeltskilt: 10

PLC-RPT- 48DC/21 - Relemodul

2900301

El-nr.: 4300195

<https://www.phoenixcontact.com/no/produkter/2900301>

ZB 6,LGS:FORTL.ZAHLEN - Merkeremse

1051016

<https://www.phoenixcontact.com/no/produkter/1051016>



Merkeremse, Strimmel, hvit, med tekst, kan merkes med: CMS-P1-PLOTTER, trykk på langs: fortløpende tall 1 ... 10, 11 ... 20 osv. til 491 ... 500, monteringsstype: feste, for klemmebredde: 6,2 mm, tekstfeltstørrelse: 6,15 x 10,5 mm, Antall enkeltskilt: 10

ZB 6,QR:FORTL.ZAHLEN - Merkeremse

1051029

<https://www.phoenixcontact.com/no/produkter/1051029>

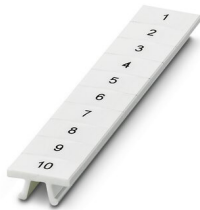

Merkeremse, Strimmel, hvit, med tekst, kan merkes med: CMS-P1-PLOTTER, trykk på tvers: fortløpende tall 1 ... 10, 11 ... 20 osv. til 491 ... 500, monteringsstype: feste, for klemmebredde: 6,2 mm, tekstfeltstørrelse: 6,15 x 10,5 mm, Antall enkeltskilt: 10

PLC-RPT- 48DC/21 - Relemodul

2900301

El-nr.: 4300195

<https://www.phoenixcontact.com/no/produkter/2900301>



ZB 6,LGS:GLEICHE ZAHLEN - Merkeremse

1051032

<https://www.phoenixcontact.com/no/produkter/1051032>



Merkeremse, Strimmel, hvit, med tekst, kan merkes med: CMS-P1-PLOTTER, trykk på langs: like tall 1 eller 2 osv. til 100, monteringsstype: feste, for klemmebredde: 6,2 mm, tekstfeltstørrelse: 6,15 x 10,5 mm, Antall enkeltskilt: 10

ZB 6,LGS:L1-N,PE - Merke for klemmer

1051414

<https://www.phoenixcontact.com/no/produkter/1051414>



Merke for klemmer, Strimmel, hvit, med tekst, kan merkes med: CMS-P1-PLOTTER, på langs: L1, L2, L3, N, PE, L1, L2, L3, N, PE, monteringsstype: feste, for klemmebredde: 6,2 mm, tekstfeltstørrelse: 6,15 x 10,5 mm, Antall enkeltskilt: 10

PLC-RPT- 48DC/21 - Relemodul

2900301

El-nr.: 4300195

<https://www.phoenixcontact.com/no/produkter/2900301>



ZB 6,LGS:U-N - Merke for klemmer

1051430

<https://www.phoenixcontact.com/no/produkter/1051430>



Merke for klemmer, Strimmel, hvit, med tekst, kan merkes med: CMS-P1-PLOTTER, trykk på langs: U, V, W, N, GND, U, V, W, N, GND, monteringsstype: feste, for klemmebredde: 6,2 mm, tekstfeltstørrelse: 6,15 x 10,5 mm, Antall enkeltskilt: 10

UC-TM 6 - Merke for klemmer

0818085

<https://www.phoenixcontact.com/no/produkter/0818085>



Merke for klemmer, Matte, hvit, uten merking, kan merkes med: BLUEMARK ID COLOR, BLUEMARK ID, BLUEMARK CLED, PLOTMARK, CMS-P1-PLOTTER, monteringsstype: feste, for klemmebredde: 6,2 mm, tekstfeltstørrelse: 5,6 x 10,5 mm, Antall enkeltskilt: 80

PLC-RPT- 48DC/21 - Relemodul

2900301

El-nr.: 4300195

<https://www.phoenixcontact.com/no/produkter/2900301>



UC-TM 6 CUS - Merke for klemmer

0824589

<https://www.phoenixcontact.com/no/produkter/0824589>



Merke for klemmer, kan bestilles: mattevis, hvit, merket etter kundespesifikasjoner, monteringsstype: feste i høyt skiltspor, for klemmebredde: 6,2 mm, tekstfeltstørrelse: 5,6 x 10,5 mm, Antall enkeltskilt: 80

UCT-TM 6 - Merke for klemmer

0828736

<https://www.phoenixcontact.com/no/produkter/0828736>



Merke for klemmer, Matte, hvit, uten merking, kan merkes med: TOPMARK NEO, TOPMARK LASER, BLUEMARK ID COLOR, BLUEMARK ID, BLUEMARK CLED, THERMOMARK PRIME, THERMOMARK CARD 2.0, THERMOMARK CARD, monteringsstype: feste, for klemmebredde: 6,2 mm, tekstfeltstørrelse: 5,6 x 10,5 mm, Antall enkeltskilt: 60

PLC-RPT- 48DC/21 - Relemodul

2900301

El-nr.: 4300195

<https://www.phoenixcontact.com/no/produkter/2900301>



UCT-TM 6 CUS - Merke for klemmer

0829602

<https://www.phoenixcontact.com/no/produkter/0829602>

Merke for klemmer, kan bestilles: mattevis, hvit, merket etter kundespesifikasjoner, monteringstype: feste i høyt skiltspor, for klemmebredde: 6,2 mm, tekstfeltstørrelse: 5,6 x 10,5 mm, Antall enkeltskilt: 60



NS 35/ 7,5 PERF 2000MM - Monteringsskinne med hull

0801733

<https://www.phoenixcontact.com/no/produkter/0801733>

Monteringsskinne med hull, Forpakkingsvariant med 25 stk. (50 m), iht. EN 60715, material: Stål, forsinket, tykkfilmpassivert, Standardprofil, farge: sølv



PLC-RPT- 48DC/21 - Relemodul

2900301

EI-nr.: 4300195

<https://www.phoenixcontact.com/no/produkter/2900301>



NS 35/ 7,5 UNPERF 2000MM - Monteringsskinne uperforet

0801681

<https://www.phoenixcontact.com/no/produkter/0801681>



Monteringsskinne uperforet, Forpakkingsvariant med 25 stk. (50 m), iht. EN 60715, material: Stål, forsinket, tykkfilmpassivert, Standardprofil, farge: sølvfarget

NS 35/ 7,5 WH PERF 2000MM - Monteringsskinne med hull

1204119

<https://www.phoenixcontact.com/no/produkter/1204119>



Monteringsskinne med hull, Forpakkingsvariant med 25 stk. (50 m), iht. EN 60715, material: Stål, forsinket, hvit-passivert, Standardprofil, farge: sølvfarget

PLC-RPT- 48DC/21 - Relemodul

2900301

El-nr.: 4300195

<https://www.phoenixcontact.com/no/produkter/2900301>



NS 35/ 7,5 WH UNPERF 2000MM-VPE 10 - Monteringsskinne uperforet

1204122

<https://www.phoenixcontact.com/no/produkter/1204122>



Monteringsskinne uperforet, Forpakkingsvariant med 10 stk. (20 m), iht. EN 60715, material: Stål, forsinket, hvit-passivert, Standardprofil, farge: sølvfarget

NS 35/ 7,5 AL UNPERF 2000MM - Monteringsskinne uperforet

0801704

<https://www.phoenixcontact.com/no/produkter/0801704>



Monteringsskinne uperforet, Forpakkingsvariant med 25 stk. (50 m), iht. EN 60715, material: Aluminium, uten belegg, Standardprofil, farge: sølvfarget

PLC-RPT- 48DC/21 - Relemodul

2900301

El-nr.: 4300195

<https://www.phoenixcontact.com/no/produkter/2900301>



NS 35/ 7,5 ZN PERF 2000MM - Monteringsskinne med hull

1206421

<https://www.phoenixcontact.com/no/produkter/1206421>



Monteringsskinne med hull, Forpakkingsvariant med 25 stk. (50 m), iht. EN 60715, material: Stål, forsinket, Standardprofil, farge: sølvfarget

NS 35/ 7,5 ZN UNPERF 2000MM - Monteringsskinne uperforet

1206434

<https://www.phoenixcontact.com/no/produkter/1206434>



Monteringsskinne uperforet, Forpakkingsvariant med 25 stk. (50 m), iht. EN 60715, material: Stål, forsinket, Standardprofil, farge: sølvfarget

PLC-RPT- 48DC/21 - Relemodul

2900301

El-nr.: 4300195

<https://www.phoenixcontact.com/no/produkter/2900301>



NS 35/ 7,5 CU UNPERF 2000MM-VPE 10 - Monteringsskinne uperforet

0801762

<https://www.phoenixcontact.com/no/produkter/0801762>



Monteringsskinne uperforet, Forpakkingsvariant med 10 stk. (20 m), iht. EN 60715, material: Kobber, uten belegg, Standardprofil, farge: kobberfarget

NS 35/ 7,5 CAP - Endehette

1206560

<https://www.phoenixcontact.com/no/produkter/1206560>

Monteringsskinne-endestykke, for monteringsskinne NS 35/7,5



PLC-RPT- 48DC/21 - Relemodul

2900301

El-nr.: 4300195

<https://www.phoenixcontact.com/no/produkter/2900301>

NS 35/15 PERF 2000MM - Monteringsskinne med hull

1201730

<https://www.phoenixcontact.com/no/produkter/1201730>



Monteringsskinne med hull, Forpakkingsvariant med 25 stk. (50 m), lignende EN 60715, material: Stål, forsinket, tykkfilmpassivert, Standardprofil, farge: sølvfarget

NS 35/15 UNPERF 2000MM - Monteringsskinne uperforert

1201714

<https://www.phoenixcontact.com/no/produkter/1201714>



Monteringsskinne uperforert, Forpakkingsvariant med 25 stk. (50 m), lignende EN 60715, material: Stål, forsinket, tykkfilmpassivert, Standardprofil, farge: sølvfarget

PLC-RPT- 48DC/21 - Relemodul

2900301

El-nr.: 4300195

<https://www.phoenixcontact.com/no/produkter/2900301>



NS 35/15 WH PERF 2000MM - Monteringsskinne med hull

0806602

<https://www.phoenixcontact.com/no/produkter/0806602>



Monteringsskinne med hull, Forpakkingsvariant med 25 stk. (50 m), lignende EN 60715, material: Stål, forsinket, hvit-passivert, Standardprofil, farge: hvit

NS 35/15 WH UNPERF 2000MM-VPE 10 - Monteringsskinne uperforet

1204135

<https://www.phoenixcontact.com/no/produkter/1204135>



Monteringsskinne uperforet, Forpakkingsvariant med 10 stk. (20 m), lignende EN 60715, material: Stål, forsinket, hvit-passivert, Standardprofil, farge: sølvfarget

PLC-RPT- 48DC/21 - Relemodul

2900301

El-nr.: 4300195

<https://www.phoenixcontact.com/no/produkter/2900301>



NS 35/15 AL UNPERF 2000MM - Monteringsskinne uperforert

1201756

<https://www.phoenixcontact.com/no/produkter/1201756>



Monteringsskinne uperforert, lignende EN 60715, material: Aluminium, uten belegg, Standardprofil, farge: sølvfarget

NS 35/15 ZN PERF 2000MM - Monteringsskinne med hull

1206599

<https://www.phoenixcontact.com/no/produkter/1206599>



Monteringsskinne med hull, Forpakkingsvariant med 25 stk. (50 m), lignende EN 60715, material: Stål, forsinket, Standardprofil, farge: sølvfarget

PLC-RPT- 48DC/21 - Relemodul

2900301

El-nr.: 4300195

<https://www.phoenixcontact.com/no/produkter/2900301>



NS 35/15 ZN UNPERF 2000MM - Monteringsskinne uperforet

1206586

<https://www.phoenixcontact.com/no/produkter/1206586>



Monteringsskinne uperforet, Forpakkingsvariant med 25 stk. (50 m), lignende EN 60715, material: Stål, forsinket, Standardprofil, farge: sølvfarget

NS 35/15 CU UNPERF 2000MM-VPE 10 - Monteringsskinne uperforet

1201895

<https://www.phoenixcontact.com/no/produkter/1201895>



Monteringsskinne uperforet, Forpakkingsvariant med 10 stk. (20 m), lignende EN 60715, material: Kobber, uten belegg, Standardprofil, farge: kobberfarget

PLC-RPT- 48DC/21 - Relemodul

2900301

El-nr.: 4300195

<https://www.phoenixcontact.com/no/produkter/2900301>



NS 35/15 CAP - Endehette

1206573

<https://www.phoenixcontact.com/no/produkter/1206573>

Monteringsskinne-endestykke, for monteringsskinne NS 35/15



NS 35/15-2,3 UNPERF 2000MM-VPE 10 - Monteringsskinne uperforet

1201798

<https://www.phoenixcontact.com/no/produkter/1201798>



Monteringsskinne uperforet, Forpkningsvariant med 10 stk. (20 m), iht. EN 60715, material: Stål, forsinket, tykkfilmpassivert, Standardprofil 2,3 mm, farge: sølvfarget

PLC-RPT- 48DC/21 - Relemodul

2900301

El-nr.: 4300195

<https://www.phoenixcontact.com/no/produkter/2900301>



PLC-ATP BK - Gruppeskilleplate

2966841

<https://www.phoenixcontact.com/no/produkter/2966841>



Isolasjonsplate, tykkelse 2 mm, plasseres på begynnelsen og slutten av hver PLC-klemmelist. Ytterligere funksjoner: Optisk skille av grupper, sikkert skille av ulike spenninger ved nabo-PLC-INTERFACES i henhold til DIN VDE 0106-101, skille

PLC-ESK GY - Mateklemme

2966508

<https://www.phoenixcontact.com/no/produkter/2966508>



Mateklemme, for mating av opptil fire potensialer, for montering på NS 35/7,5

PLC-RPT- 48DC/21 - Relemodul

2900301

El-nr.: 4300195

<https://www.phoenixcontact.com/no/produkter/2900301>



SZF 1-0,6X3,5 - Skrutrekker

1204517

<https://www.phoenixcontact.com/no/produkter/1204517>



Betjeningsverktøy, for ST-klemmer, også egnet som sporskrutrekker, størrelse: 0,6 x 3,5 x 100 mm, 2-komponentshåndtak, med antiskligrep

REL-MR- 24DC/21 - Enkeltrelé

2961105

<https://www.phoenixcontact.com/no/produkter/2961105>

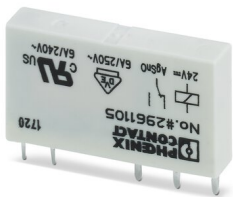

Pluggbart miniatyreffektrelé, med effektkontakt, en vekselkontakt, inngangsspenning 24 V DC

Phoenix Contact 2023 © - Alle rettigheter forbeholdt

<https://www.phoenixcontact.com>

PHOENIX CONTACT AS

Strømsveien 344

N-1081 Oslo

+47 22 07 68 00

norge@phoenixcontact.com