

ESKV 32 BK

Cable gland, polyamide, M32, RAL 9005 with short thread

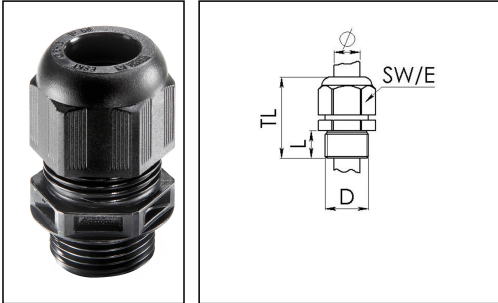

Products may differ in size, colour and appearance to those shown. If you require further information or customisation, please contact us directly.



Material cable gland	Polyamide
Material sealing gasket	EPDM
Protection class	IP69, IP68 (5 bar 30 min)
Temp. range min	-40 °C
Temp. range max	100 °C
Glow wire test	750 °C
Thread type	M
Ø Connection thread D	32
Lead	1,5
Length screw-in thread L	12 mm
Ø cable diameter min	13 mm
Ø cable diameter max	21 mm
Key width SW	36 mm
Collar diameter (E)	40 mm
Total length TL	42 mm - 51 mm
Type of cable anchorage	A
Install. torques fitting	15 N m
Install. torques fitting/EADR	4 N m
Install. torques cap nut	4 N m
Impact category	4
Product Color	RAL 9005
Type	ESKV 32 BK
Order no. RAL 9005	10066124
Packing unit	25
EAN number	4007685661249

Your Contact:

WISKA Hoppmann GmbH

Kisdorfer Weg 28 · 24568 Kaltenkirchen · Germany

☎ +49-4191-508-0 · 📠 +49-4191-508-209

contact@wiska.de · www.wiska.com

Tariff number	39269097
ETIM-Classification	EC000441

Recommended accessories

EMUG 32 BK	10061784
RDE 32	10062186
EADR 32	10062805
BS 21	10064014
MFD 32/04/070	10064344
MFD 32/06/060	10064345
MFD 32/04/080	10064950
MFD 32/03/080	10101018
MFD 32/05/070	10101140
MFD 32/01/115-01/085	10101256
MFD 32/03/065	10102169
MFD 32/03/090	10102170

14.05.2024

Your Contact:

WISKA Hoppmann GmbH

Kisdorfer Weg 28 · 24568 Kaltenkirchen · Germany

☎ +49-4191-508-0 · 📠 +49-4191-508-209

contact@wiska.de · www.wiska.com



Your Contact:

WISKA Hoppmann GmbH

Kisdorfer Weg 28 · 24568 Kaltenkirchen · Germany

☎ +49-4191-508-0 · 📠 +49-4191-508-209

contact@wiska.de · www.wiska.com