

INSTALLATION INSTRUCTION

Enclosed safety switches OT63...1000

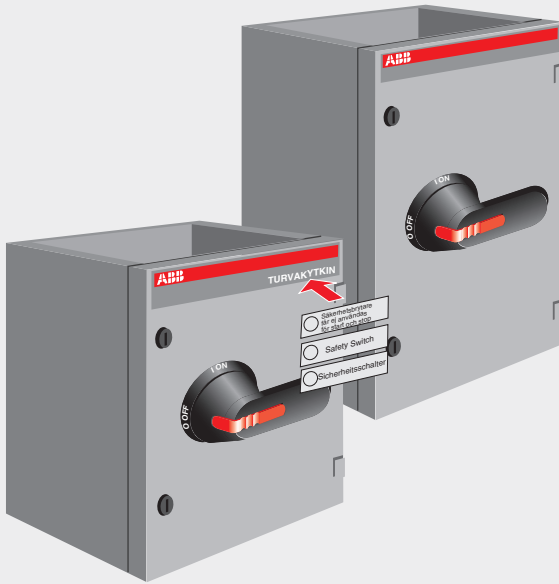

OT63...1000

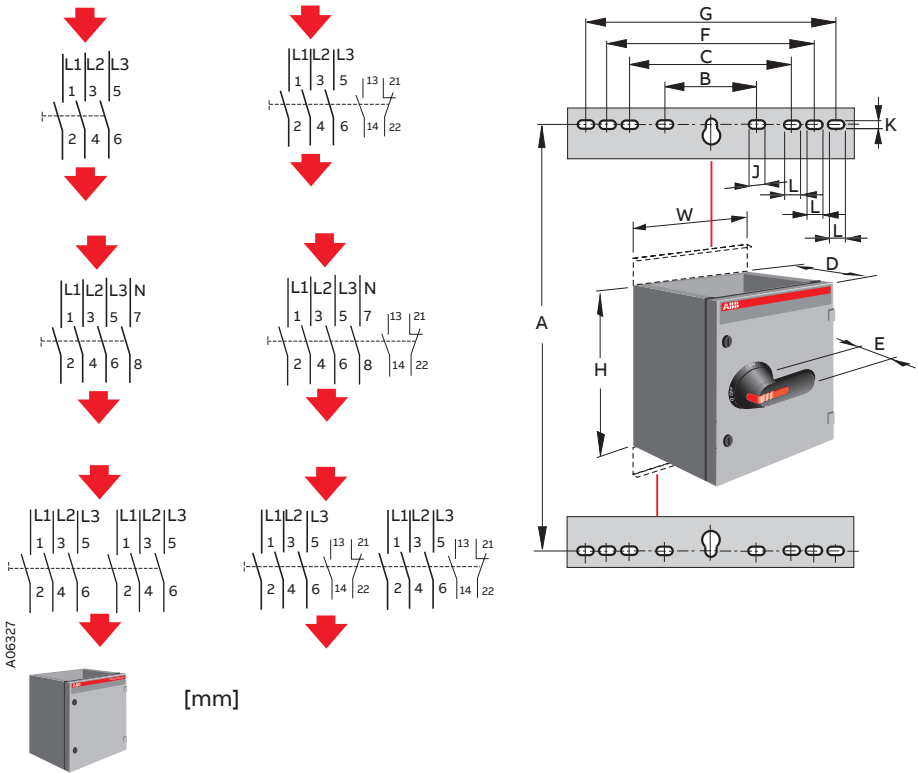

	H	W	D	E	A	B	C	F	G	J	K	L
400 x 250 x 180	400	250	180	45	445	162	-	-	-	27	11	-
400 x 400 x 230	400	400	230	45	445	303	-	-	-	35	11	-
600 x 400 x 230	600	400	230	45	645	303	-	-	-	35	11	-
800 x 400 x 230	800	400	230	45	845	303	-	-	-	35	11	-
600 x 800 x 230	600	800	230	45	645	303	512	612	712	35	11	27
800 x 800 x 230	800	800	230	45	845	303	512	612	712	35	11	27
1000 x 400 x 230	1000	400	230	45	1045	303	-	-	-	35	11	-
1000 x 800 x 230	1000	800	230	45	1045	303	512	612	712	35	11	27
1000 x 400 x 330	1000	400	330	45	1045	303	-	-	-	35	11	-
1000 x 800 x 330	1000	800	330	45	1045	303	512	612	712	35	11	27
1200 x 800 x 230	1200	800	230	45	1245	303	512	612	712	35	11	27
1200 x 800 x 330	1200	800	330	45	1245	303	512	612	712	35	11	27

OT63...1000

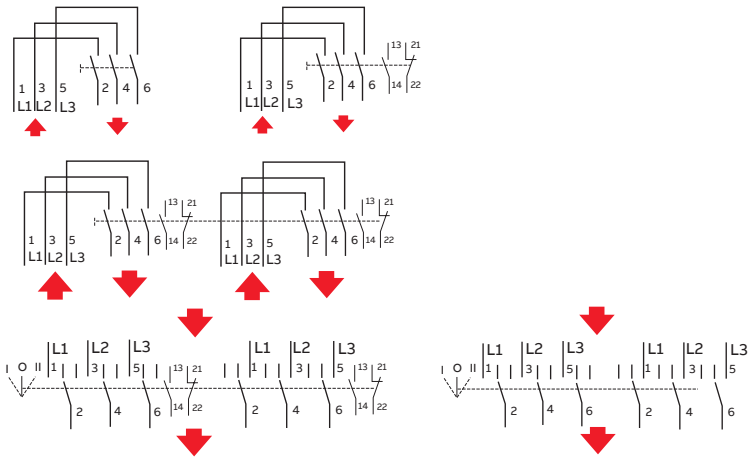





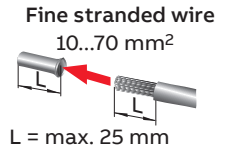
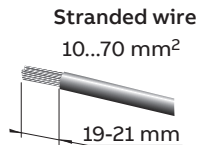
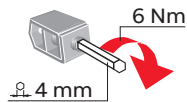





A06328A

OT90G_ OT125G_

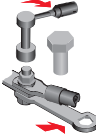

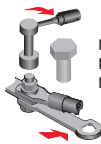
A09133

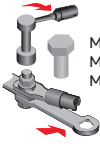
OT63...1000

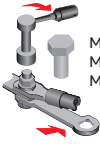
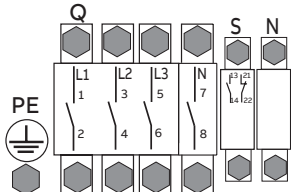
[Nm] 			
PE	Q	S	N
 M8 6 Nm  30 Nm  M6 2,5 Nm  M8 6 Nm  M8 15...22 Nm M10 30...44 Nm M12 50...75 Nm	 M8 6 Nm  M8 15...22 Nm M10 30...44 Nm M12 50...75 Nm	 0,8 Nm  M8 15...22 Nm M10 30...44 Nm M12 50...75 Nm	 2,2 Nm  M8 6 Nm  M8 15...22 Nm M10 30...44 Nm M12 50...75 Nm
			

OT63...1000

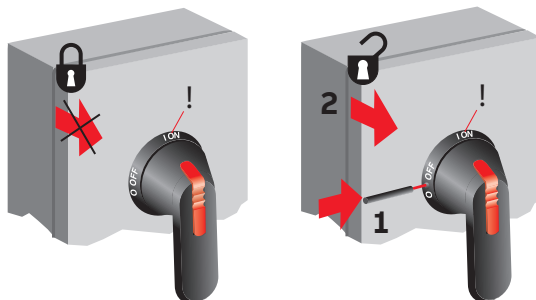

Ø5...10 mm



A06332



BG	Внимание! Опасно напряжение! Да се монтира само от лице с електротехническа квалификация.
CN	警告！电压危险！只能由专业电工进行安装。
CZ	Varování! Nebezpečné napětí! Montáž smí provádět výhradně elektrotechnik!
DA	Advarsel! Farlig elektrisk spænding! Installation må kun foretages af personer med elektroteknisk ekspertise.
DE	Warnung! Gefährliche Spannung! Installation nur durch elektrotechnische Fachkraft.
EL	Προειδοποίηση! Υψηλή τάση! Η εγκατάσταση πρέπει να γίνεται μόνο από εξειδικευμένους ηλεκτροτεχνικούς.
EN	Warning! Hazardous voltage! Installation by person with electrotechnical expertise only.
ES	¡Advertencia! ¡Tensión peligrosa! La instalación deberá ser realizada únicamente por electricistas especializados.
ET	Hoiatus! Ohtlik pinge. Paigaldada võib ainult elektrotehnika-alane ekspert.
FI	Varoitus! Vaarallinen jännite! Asennuksen voi tehdä vain sähköalan ammattihenkilö.
FR	Avertissement! Tension électrique dangereuse! Installation uniquement par des personnes qualifiées en électrotechnique.
HR	Upozorenje! Opasan napon! Postavljati smije samo elektrotehnički stručnjak.
HU	Figyelmeztetés! Veszélyes feszültség! Csak elektrotechnikai tapasztalattal rendelkező szakember helyezheti üzembe.
IE	Rabhadh! Voltas guaiseach! Ba chóir do dhuine ag a bhfuil saineolas leictreicniúil, agus an té sin ainmáin, é seo a shuiteáil.
IT	Avvertenza! Voltaggio pericoloso! Fare installare solo da un elettricista qualificato.
LT	Dėmesio! Pavojinga įtampa! Dirbti leidžiama tik elektrotechnikai patirties turintiems asmenims.
LV	Uzmanību! Bīstami - elektrība! Montāžas darbus drīkst veikt tikai personas, kurām ir atbilstošas elektrotehniskās zināšanas.
MT	Twissija! Voltagg perikoluż! Għandu jiġi installat biss minn persuna b'kompetenza elettroteknika.
NL	Waarschuwing! Gevaarlijke spanning! Mag alleen geïnstalleerd worden door een deskundige elektrotechnicus.
NO	Advarsel! Farlig spenning! Montering skal kun utføres av kvalifiserte personer med elektrokompetanse.
PL	Ostrzeżenie! Niebezpieczne napięcie! Instalacji może dokonać wyłącznie osoba z fachową wiedzą w dziedzinie elektrotechniki.
PT	Aviso! Tensão perigosa! A instalação só deve ser realizada por um electricista especializado.
RO	Avertizare! Tensiune periculoasă! Instalarea trebuie efectuată numai de către o persoană cu experiență în electrotehnică.
RU	Осторожно! Опасное напряжение! Монтаж должен выполняться только специалистом-электриком.
SE	Varning! Farlig spänning! Installation får endast utföras av en elektriker.
SK	Varovanie! Nebezpečné napätie! Montáž môže vykonávať iba skúsený elektrotechnik.
SL	Opozorilo! Nevarna napetost! Vgradnjo lahko opravi le oseba z elektrotehničnim strokovnim znanjem.



Contact us

ABB Oy

Muottitie 2A 65320

Vaasa, Finland

abb.com/lowvoltage