

Produktdatablad

Spesifikasjoner



Lystrykknapphode i metall for BA9s med fjærretur og plan trykflate i hvit farge

El-nummer:
4302730

ZB4BW31

EAN: 3389110889697

Produktdata

Produktspekter	Harmony XB4
Produkt eller type komponent	Hode for lystrykknapper
Kortnavn på utstyr	ZB4
Produktkompatibilitet	BA 9s
Innfatningsmateriale	Forkrommet metall
Hode type	Standard
Montasjediameter	22,5 mm
Salg per udelelig kvantitet	1
Formen på varslingsenhetens hode	Rund
Type arm/stempel	fjærretur
operatørprofil	Hvit innfelt, umerket
knappens tilleggs info.	Med vanlig deksel
Hette eller deksselfarge	Hvit

Teknisk data

Bredde	29 mm
Høyde	29 mm
Dybde	32 mm
Vekt	0,027 kg
resistens til høytrykksvask	7000000 Pa på 55 °C, distanse : 0.1 m
Mekanisk levetid	10000000 sykluser
elektrisk sammensetningskode	M7 for <6 kontakter bruker Enkel blokker i frontmontering med BA 9s M8 for <6 kontakter bruker enkel og dobbel blokker i frontmontering med BA 9s M9 for <2 kontakter bruker Enkel blokker i frontmontering med BA 9s og transformator
Enhetens utseende	Basic sub-assemblies

Miljø

Overflatebeskyttelse	TH
Omgivelsestemperatur for lagring	-40...70 °C
Omgivelsestemperatur drift	-40...55 °C
Overspenningskategori	Klasse I conforming to IEC 60536

IP-grad	IP66 i samsvar med IEC 60529 IP67 IP69 IP69K
NEMA beskyttelsesgrad	NEMA 13 NEMA 4X
Ik beskyttelsesklasse	IK06 i samsvar med IEC 62262
Standarder	CSA C22.2 No 14 JIS C8201-5-1 UL 508 IEC 60947-1 IEC 60947-5-1 IEC 60947-5-5 IEC 60947-5-4 JIS C8201-1
Produktsertifikater	CSA LROS (Lloyds register of shipping) BV UL listet DNV
Vibrasjonsmotstand	5 gn (f= 2...500 Hz) conforming to IEC 60068-2-6
støtmotstand	30 gn (varighet = 18 ms) for halvsinuskurve akselerasjon i samsvar med IEC 60068-2-27 50 gn (varighet = 11 ms) for halvsinuskurve akselerasjon i samsvar med IEC 60068-2-27

Forpakkingsinformasjon

Enhetsstype pakke 1	PCE
Antall enheter i pakke 1	1
Pakke 1 Høyde	5,6 cm
Pakke 1 Bredde	3,4 cm
Pakke 1 Vekt	4,5 cm
Package 1 Weight	28,0 g
Enhetsstype pakke 2	S01
Antall enheter i pakke 2	50
Pakke 2 Høyde	15,0 cm
Pakke 2 Bredde	15,0 cm
Pakke 2 Lengde	40,0 cm
Pakke 2 Vekt	1,6 kg

Logistikkinformasjon

Opprinnelsesland	CZ
-------------------------	----

Garantiperiode

Garanti	18 months
----------------	-----------

Environmental Data

Schneider Electric tar sikte på å oppnå Net Zero-status innen 2050 gjennom partnerskap med leverandørkjeden, materialer med lavere slagkraft og sirkularitet via vår pågående "Use Better, Use Longer, Use Again"-kampanje for å forlenge produktlevetiden og resirkulerbarheten.

[Environmental Data forklart >](#)

[Hvordan vi vurderer produktets bærekraft >](#)

Miljøfotavtrykk

Samlet klimagassutslipp gjennom livsløpet 1

PEP (Product Environmental Profile) [Produktmiljøprofil](#)

Use Better

Materialer og emballasje

Emballasje med resirkulert papp Nei

Emballasje uten plast Nei

[EU RoHS-direktiv](#) Proaktivt i samsvar (Produktet inngår ikke i EUs RoHS direktivet)

REACH-regelverk [REACH-erklæring](#)

Use Again

Ompakking og reproduksjon

Produktets livssyklus [Informasjon om levetidsslutt](#)

Tilbaketakning No

Dimensions Drawings

Dimensions

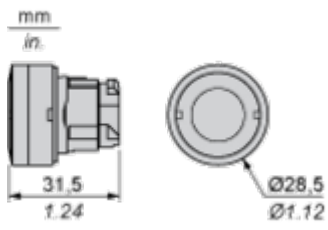

Mounting and Clearance

Panel Cut-out for Pushbuttons, Switches and Pilot Lights (Finished Holes, Ready for Installation)

Connection by Screw Clamp Terminals or Plug-in Connectors or on Printed Circuit Board	Connection by Faston Connectors
	
<p>(1) Diameter on finished panel or support (2) 40 mm min. / 1.57 in. min. (3) 30 mm min. / 1.18 in. min. (4) $\varnothing 22.5 \text{ mm} / 0.89 \text{ in.}$ recommended ($\varnothing 22.3 \text{ mm} \begin{smallmatrix} +0.4 \\ 0 \end{smallmatrix} / 0.88 \text{ in.} \begin{smallmatrix} +0.016 \\ 0 \end{smallmatrix}$) (5) 45 mm min. / 1.78 in. min. (6) 32 mm min. / 1.26 in. min.</p>	

Pushbuttons, Switches and Pilot Lights for Printed Circuit Board Connection

Panel Cut-outs (Viewed from Installer's Side)

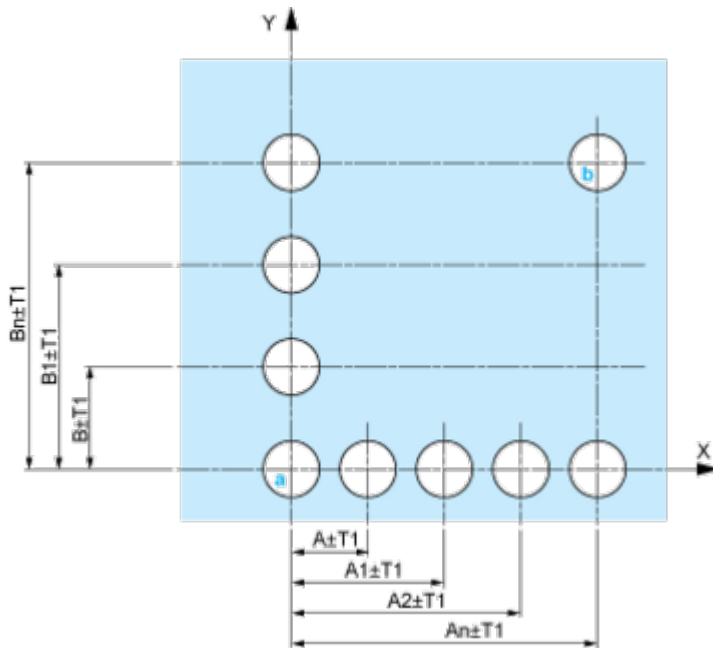

A: 30 mm min. / 1.18 in. min.

B: 40 mm min. / 1.57 in. min.

Printed Circuit Board Cut-outs (Viewed from Electrical Block Side)

Dimensions in mm

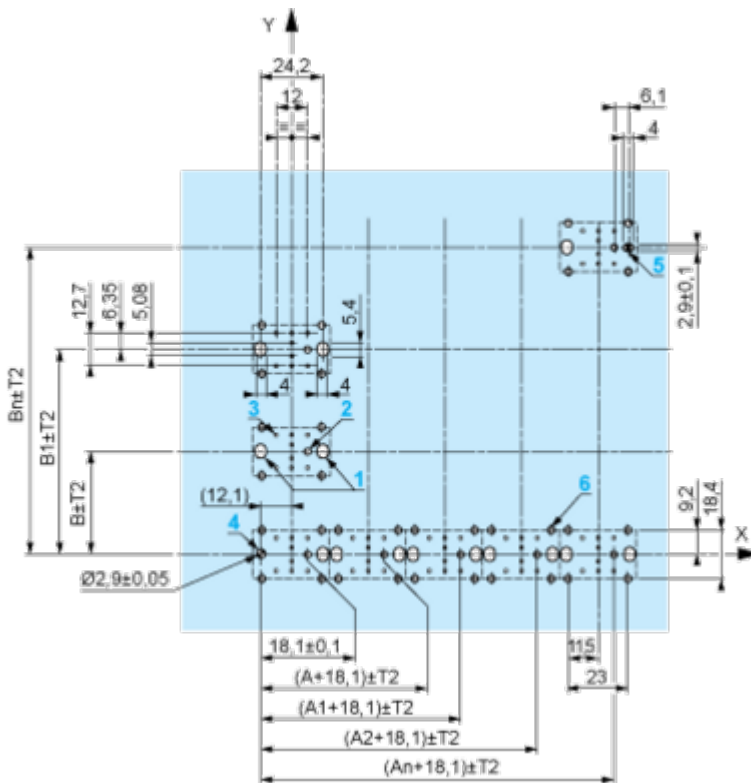

A: 30 mm min.

B: 40 mm min.

Dimensions in in.



A: 1.18 in. min.
 B: 1.57 in. min.

General Tolerances of the Panel and Printed Circuit Board

The cumulative tolerance must not exceed 0.3 mm / 0.012 in: T1 + T2 = 0.3 mm max.

Installation Precautions

- Minimum thickness of circuit board: 1.6 mm / 0.06 in.
- Cut-out diameter: 22.4 mm ± 0.1 / 0.88 in. ± 0.004
- Orientation of body/fixing collar ZB4 BZ009: ± 2° 30' (excluding cut-outs marked a and b).
- Tightening torque of screws ZBZ 006: 0.6 N.m (5.3 lbf.in) max.
- Allow for one ZB4 BZ079 fixing collar/pillar and its fixing screws:
 - every 90 mm / 3.54 in. horizontally (X), and 120 mm / 4.72 in. vertically (Y).
 - with each selector switch head (ZB4 BD*, ZB4 BJ*, ZB4 BG*).

The fixing centers marked a and b are diagonally opposed and must align with those marked 4 and 5.



(1) Panel

(2) Printed circuit board

Mounting of Adapter (Socket) ZBZ 01•

- 1 2 elongated holes for ZBZ 006 screw access
- 2 1 hole \varnothing 2.4 mm \pm 0.05 / 0.09 in. \pm 0.002 for centring adapter ZBZ 01•
- 3 8 \times \varnothing 1.2 mm / 0.05 in. holes
- 4 1 hole \varnothing 2.9 mm \pm 0.05 / 0.11 in. \pm 0.002, for aligning the printed circuit board (with cut-out marked a)
- 5 1 elongated hole for aligning the printed circuit board (with cut-out marked b)
- 6 4 holes \varnothing 2.4 mm / 0.09 in. for clipping in adapter ZBZ 01•

Dimensions An + 18.1 relate to the \varnothing 2.4 mm \pm 0.05 / 0.09 in. \pm 0.002 holes for centring adapter ZBZ 01•.

Technical Description

Electrical Composition Corresponding to Codes M1 and M7

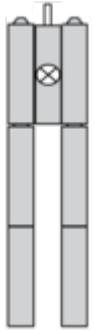

Electrical Composition Corresponding to Codes M2 and M8

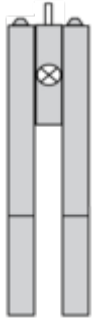

Electrical Composition Corresponding to Code M9

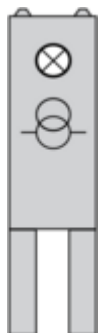

Legend

Single contact



Double contact



Light block



Possible location



Technical Illustration

Dimensions

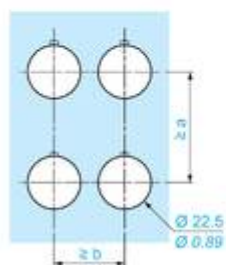
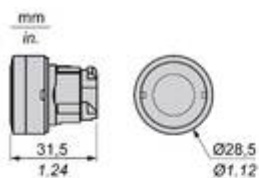

		a (mm)	a (in.)	b (mm)	b (in.)
		40	1.57	30	1.18
ZBE.....	ZBV.....				
		45	1.77	32	1.26
ZBE.....3	ZBV.....3				
		40	1.57	30	1.18
ZBE.....4	ZBV.....4				
		50	1.97	30	1.18
ZBE.....5	ZBV.....5				
		40	1.57	30	1.18
ZBE.....9	ZBV.....9				
		40	1.57	30	1.18
ZBRT•	ZBRV1				

Offer Marketing Illustration

Product benefits / Features

The graphic features a green background with the title "Features" and subtitle "Harmony XB4/XB5 Illuminated functions". It contains four feature descriptions, each with an icon and a corresponding image of a switch component:

- NEW universal LED Block for all colors:** Represented by a square icon with a smaller square inside. The image shows a green switch with a black LED block.
- Simple stock management:** Represented by a person icon. The image shows a red switch and a black LED block.
- Improved installation time and easy selection:** Represented by a circular arrow icon. The image shows a yellow switch.
- Improved color intensity and brightness:** Represented by a sun icon. The image shows a yellow switch.

Offer Marketing Illustration

Product benefits / Features

Technical Benefits

Harmony XB4

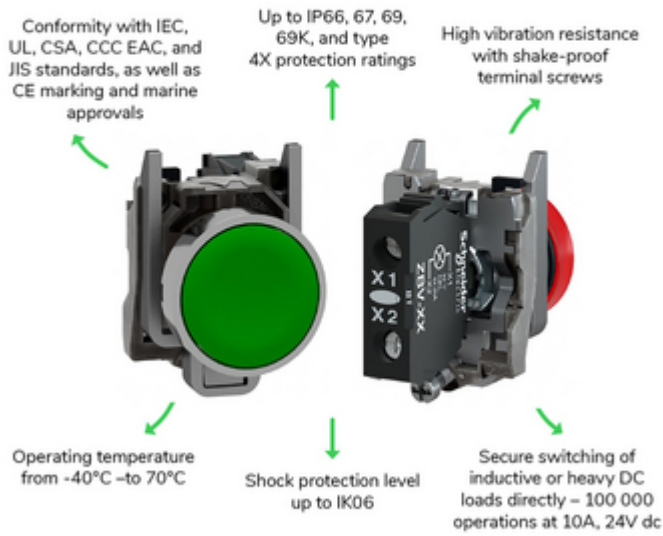

Offer Marketing Illustration

Product benefits / Features

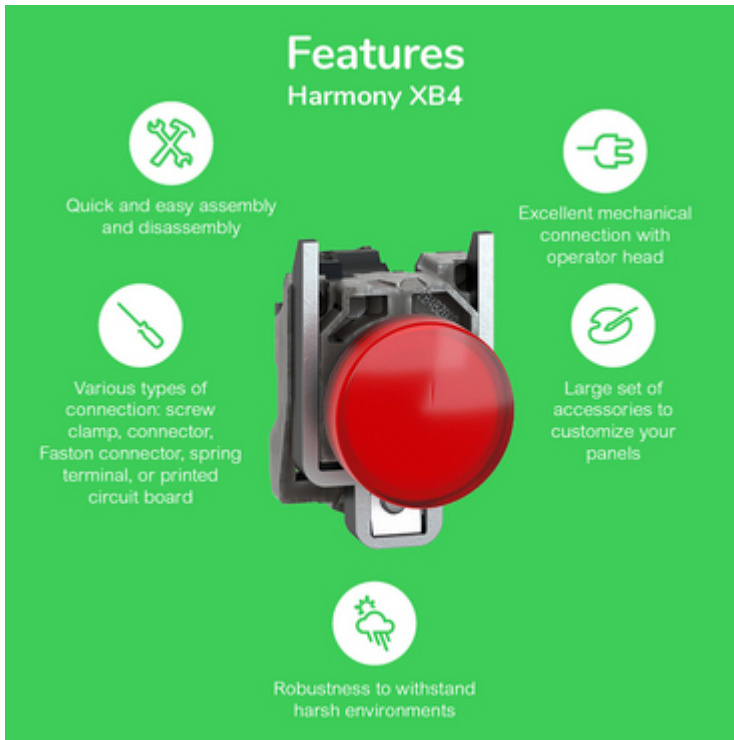

The infographic features a central image of a red Schneider XB4 circuit breaker. It is surrounded by five circular icons, each with a corresponding text description of a feature. The background is a solid green color.

Features Harmony XB4





-  Quick and easy assembly and disassembly
-  Various types of connection: screw clamp, connector, Faston connector, spring terminal, or printed circuit board
-  Excellent mechanical connection with operator head
-  Large set of accessories to customize your panels
-  Robustness to withstand harsh environments

Image of product / Alternate images

Alternative

