

Produktdatablad

Spesifikasjoner



Nøkkelsbryterhode flush i plast med 3 posisjoner med fjærretur til midt og nøkkel (8D1) ut i M

EI-nummer:
4307584

ZB5FG7D

EAN: 3606481340221

Produktdata

Produktspekter	Harmony XB5
Produkt eller type komponent	Hode for nøkkelvendere
Kortnavn på utstyr	ZB5
Innfatningsmateriale	Dark grey plastic
Montasjediameter	30,5 mm
Hode type	Built-in-flush
Salg per udelelig kvantitet	1
Formen på varslingsenhetens hode	Rund
Type arm/stempel	Til senter fjærretur
operatørprofil	Sort nøkkelsbryter
informasjon om knappens stilling	3 posisjoner +/- 45°
Type nøkkellås	Dom 8D1 Key 3131A
nøkkel uttrekksposisjon	Senter

Teknisk data

Bredde	37 mm
Høyde	37 mm
Dybde	72 mm
Vekt	0,069 kg
Mekanisk levetid	1000000 sykluser
elektrisk sammensetningskode	C4 for <6 kontakter bruker enkel og dobbel blokker i frontmontering C5 for <5 kontakter bruker Enkel blokker i frontmontering C6 for <5 kontakter bruker enkel og dobbel blokker i frontmontering C7 for <4 kontakter bruker Enkel blokker i frontmontering C8 for <4 kontakter bruker enkel og dobbel blokker i frontmontering C11 for <3 kontakter bruker Enkel blokker i frontmontering C3 for <6 kontakter bruker Enkel blokker i frontmontering SF1 for <3 kontakter bruker Enkel blokker i frontmontering

Miljø

Overflatebeskyttelse	TH
Omgivelsestemperatur for lagring	-40...70 °C
Omgivelsestemperatur drift	-40...70 °C
Overspenningskategori	Klasse II conforming to IEC 60536

IP-grad	IP66 i samsvar med IEC 60529 IP67 IP69 IP69K
NEMA beskyttelsesgrad	NEMA 13 NEMA 4X
resistens til høytrykksvask	7000000 Pa på 55 °C, distanse : 0.1 m
Ik beskyttelsesklasse	IK03 i samsvar med IEC 50102
Standarder	JIS C8201-5-1 IEC 60947-1 IEC 60947-5-4 CSA C22.2 No 14 IEC 60947-5-1 UL 508 JIS C8201-1
Produktsertifikater	CSA DNV BV LROS (Lloyds register of shipping) UL listet
Vibrasjonsmotstand	5 gn (f= 2...500 Hz) conforming to IEC 60068-2-6
støtmotstand	30 gn (varighet = 18 ms) for halvsinusurve akselerasjon i samsvar med IEC 60068-2-27 50 gn (varighet = 11 ms) for halvsinusurve akselerasjon i samsvar med IEC 60068-2-27

Forpakkingsinformasjon

Enhetsstype pakke 1	PCE
Antall enheter i pakke 1	1
Pakke 1 Høyde	8,6 cm
Pakke 1 Bredde	4,3 cm
Pakke 1 Vekt	5,2 cm
Package 1 Weight	73,0 g

Garantiperiode

Garanti	18 måneder
----------------	------------

Environmental Data

Schneider Electric tar sikte på å oppnå Net Zero-status innen 2050 gjennom partnerskap med leverandørkjeden, materialer med lavere slagkraft og sirkularitet via vår pågående "Use Better, Use Longer, Use Again"-kampanje for å forlenge produktlevetiden og resirkulerbarheten.

[Environmental Data forklart >](#)

[Hvordan vi vurderer produktets bærekraft >](#)

Miljøfotavtrykk

Samlet klimagassutslipp gjennom livsløpet 1

PEP (Product Environmental Profile) [Produktmiljøprofil](#)

Use Better

Materialer og emballasje

Emballasje med resirkulert papp Ja

Emballasje uten plast Ja

[EU RoHS-direktiv](#) Proaktivt i samsvar (Produktet inngår ikke i EUs RoHS direktivet)

SCIP-nummer F28cb399-1b6a-409d-ac7b-4169e47b25c8

REACH-regelverk [REACH-erklæring](#)

Use Again

Ompakking og reproduksjon

Produktets livssyklus [Informasjon om levetidsslutt](#)

Tilbaketakning No

Dimensions Drawings

Dimensions

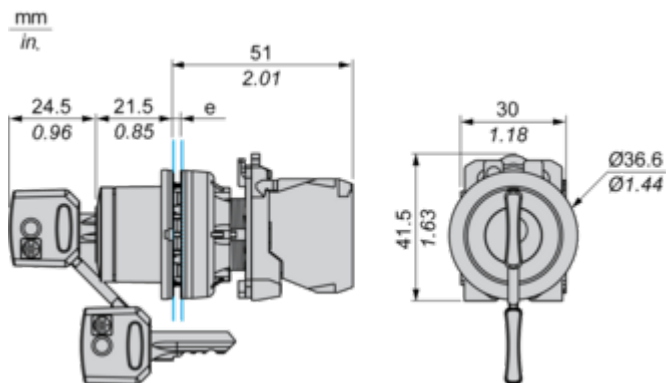

e: Clamping thickness: 1 to 6 mm / 0.04 to 0.24 in.

Mounting and Clearance

Panel Cut-out for Pushbuttons, Switches and Pilot Lights (Finished Holes, Ready for Installation)

Connection by Screw Clamp Terminals or Plug-in Connectors

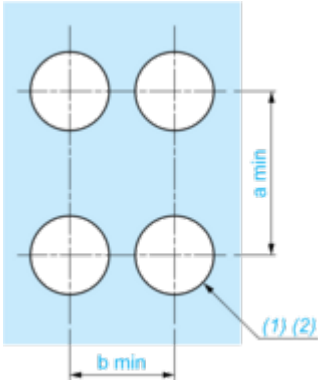

(1) Diameter on finished panel or support

(2) $\text{Ø}30.75 \text{ mm}$ recommended ($\text{Ø}30.5 \text{ }_0^{+0.5}$) / $\text{Ø}1.21 \text{ in.}$ recommended ($\text{Ø}1.20 \text{ in. }_0^{+0.0196}$)

Connections	a in mm	a in in.	b in mm	b in in.
By screw clamp terminals or plug-in connector	40	1.57	40	1.57
By Faston connectors	45	1.77	40	1.57

Technical Description

Electrical Composition Corresponding to Code C3



Electrical Composition Corresponding to Code C4



Electrical Composition Corresponding to Code C5

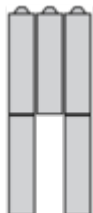

Electrical Composition Corresponding to Code C6



Electrical Composition Corresponding to Code C7

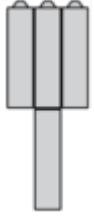

Electrical Composition Corresponding to Code C8

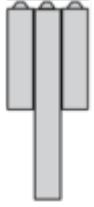

Electrical Composition Corresponding to Codes C9, C11, SF1 and SR1

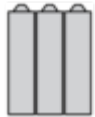

Electrical Composition Corresponding to Code C15

1 N/O

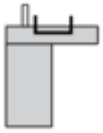

1 N/C



1 N/O + N/C or 1 N/O + N/O or 1 N/C + N/C

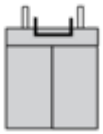

Legend

Single contact



Double contact



Light block







Possible location



Sequence of Contacts Fitted to 2-position Selector Switch Body

Position 315°



Push	Position	Top			
		Bottom			
	Location		Left	Centre	Right
	State		0	0	0
	Contacts		N/O	open	open
		N/C	closed	closed	closed

Position 45°





Push	Position	Top			
		Bottom			
	Location		Left	Centre	Right
	State		1	1	1
Contacts		N/O	closed	closed	closed
		N/C	open	open	open

Technical Illustration

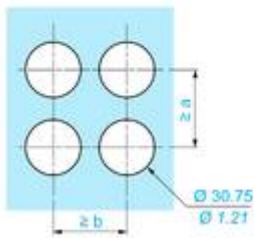
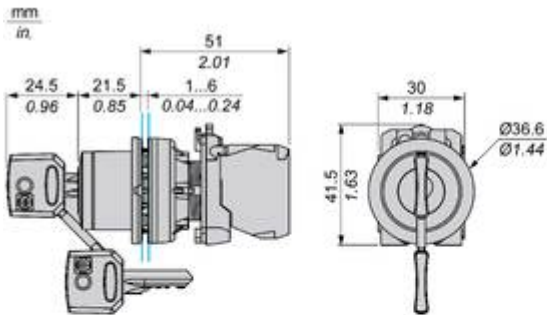
Dimensions

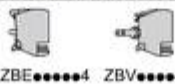

	a (mm)	a (in.)	b (mm)	b (in.)
 ZBE..... ZBV.....	40	1.57	40	1.57
 ZBE.....3 ZBV.....3	45	1.77	40	1.57
 ZBE.....4 ZBV.....4	40	1.57	40	1.57