

Produktdatablad

Spesifikasjoner



Venderhode flush i metall for LED med 3 posisjoner med fjærretur til midt og grep i grønn farge

El-nummer:
4305863

ZB4FK1533

Viktig melding: A change in appearance may be noted on the product but does not affect its use in terms of function and safety. This makes it compatible with our Universal LED blocks
EAN: 3606489582210

Produktdata

Produktspekter	Harmony XB4
Produkt eller type komponent	Hode for lysvendere
Produktkompatibilitet	Universal LED
Kortnavn på utstyr	ZB4F
Innfatningsmateriale	Forkrommet metall
Hode type	Built-in-flush
Montasjediameter	30,5 mm
Salg per udelelig kvantitet	1
Formen på varslingsenhetens hode	Rund
Type arm/stempel	Til senter fjærretur
operatørprofil	Grønn standard grep
informasjon om knappens stilling	3 posisjoner +/- 45°
Hette eller dekselfarge	Grønn

Teknisk data

Bredde	36,6 mm
Høyde	36,6 mm
Dybde	47 mm
Vekt	0,078 kg
resistens til høytrykksvask	7000000 Pa på 55 °C, distanse : 0.1 m
Mekanisk levetid	500000 sykluser
elektrisk sammensetningskode	M3 for <4 kontakter bruker Enkel blokker i frontmontering med innebygget LED M6 for <2 kontakter bruker Enkel blokker i frontmontering med integrert LED og transformator M10 for <2 kontakter bruker Enkel blokker i frontmontering med innebygget LED M4 for <4 kontakter bruker enkel og dobbel blokker i frontmontering med innebygget LED
Enhetens utseende	Basic element

Miljø

Overflatebeskyttelse	TH
Omgivelsestemperatur for lagring	-40...70 °C

Omgivelsestemperatur drift	-40...70 °C
Overspenningskategori	Klasse I conforming to IEC 60536
IP-grad	IP66 i samsvar med IEC 60529 IP67 i samsvar med IEC 60529 IP69 i samsvar med IEC 60529 IP69K i samsvar med ISO 20653 Type 13 i samsvar med UL 50 E Type 12 i samsvar med UL 50 E Type 4 i samsvar med UL 50 E Type 4X i samsvar med UL 50 E
Ik beskyttelsesklasse	IK04 i samsvar med IEC 50102
Standarder	CSA C22.2 No 14 IEC 60947-5-1 IEC 60947-5-4 UL 508 IEC 60947-1 JIS C8201-5-1 CE JIS C8201-1
Produktsertifikater	UL listet CSA CCC EAC
Vibrasjonsmotstand	5 gn (f= 10...500 Hz) conforming to IEC 60068-2-6 2mm topp til topp (f= 2...10 Hz) conforming to IEC 60068-2-6
støtmotstand	30 gn (varighet = 18 ms) for halvsinusurve akselerasjon i samsvar med IEC 60068-2-27 50 gn (varighet = 11 ms) for halvsinusurve akselerasjon i samsvar med IEC 60068-2-27 25 gn (varighet = 6 ms) for 1000 sjokk på hver akse i samsvar med IEC 60068-2-27

Forpakkingsinformasjon

Enhetsstype pakke 1	PCE
Antall enheter i pakke 1	1
Pakke 1 Høyde	5,500 cm
Pakke 1 Bredde	4,400 cm
Pakke 1 Vekt	5,200 cm
Package 1 Weight	68,600 g
Enhetsstype pakke 2	BB1
Antall enheter i pakke 2	5
Pakke 2 Høyde	5,500 cm
Pakke 2 Bredde	4,400 cm
Pakke 2 Lengde	26,500 cm
Pakke 2 Vekt	343,000 g
Enhetsstype pakke 3	S02
Antall enheter i pakke 3	80
Pakke 3 Høyde	15,000 cm
Pakke 3 Bredde	30,000 cm
Pakke 3 Lengde	40,000 cm
Pakke 3 Vekt	5,818 kg

Logistikkinformasjon

Opprinnelsesland

FR

Garantiperiode

Garanti

18 months

Environmental Data

Schneider Electric tar sikte på å oppnå Net Zero-status innen 2050 gjennom partnerskap med leverandørkjeden, materialer med lavere slagkraft og sirkularitet via vår pågående "Use Better, Use Longer, Use Again"-kampanje for å forlenge produktlevetiden og resirkulerbarheten.

[Environmental Data forklart >](#)

[Hvordan vi vurderer produktets bærekraft >](#)

Miljøfotavtrykk

Samlet klimagassutslipp gjennom livsløpet 1

PEP (Product Environmental Profile) [Produktmiljøprofil](#)

Use Better

Materialer og emballasje

Emballasje med resirkulert papp Ja

Emballasje uten plast Ja

[EU RoHS-direktiv](#) Proaktivt i samsvar (Produktet inngår ikke i EUs RoHS direktivet)

REACH-regelverk [REACH-erklæring](#)

Use Again

Ompakking og reproduksjon

Produktets livssyklus [Informasjon om levetidsslutt](#)

Tilbaketakning No

Dimensions Drawings

Dimensions

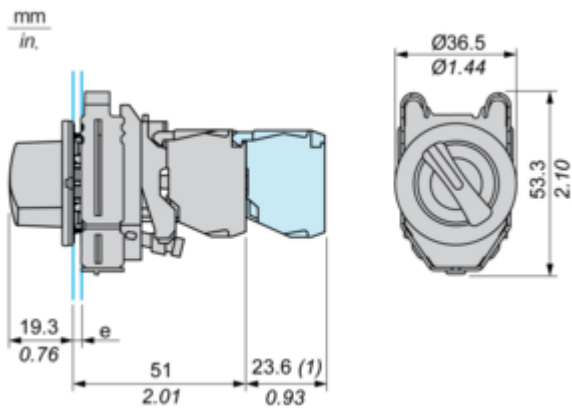

e : clamping thickness: 1 to 6 mm / 0.04 to 0.24 in.

(1) : Additional row of contacts

Mounting and Clearance

Panel Cut-out for Pushbuttons, Switches and Pilot Lights (Finished Holes, Ready for Installation)

Connection by Screw Clamp Terminals or Plug-in Connectors

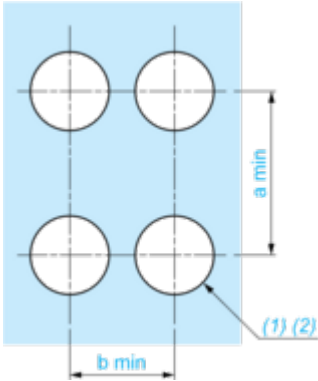

(1) : Diameter on finished panel or support

(2) : $\varnothing 30.75$ mm recommended ($\varnothing 30.5_0^{+0.5}$) / $\varnothing 1.21$ in. recommended ($\varnothing 1.20$ in. $_0^{+0.0196}$)

Connections	a in mm	a in in.	b in mm	b in in.
By connectors	50	1.97	40	1.57
By connectors and with legend holder ZBZF32	50	1.97	40	1.57
By connectors and with legend holder ZBZF33	60	2.36	40	1.57

Technical Description

Electrical Composition Corresponding to Code M3

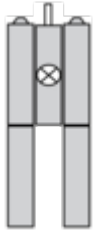

Electrical Composition Corresponding to Code M4



Electrical Composition Corresponding to Codes M6 and P2



Electrical Composition Corresponding to Codes M5, M10, MF1, MR1 and MF2

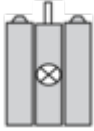

Legend

Single contact



Double contact



Light block



Possible location



Sequence of Contacts Fitted to 3-position Selector Switch Body

Position 315°



Push	Position	Top			
		Bottom			
	Location		Left		Right
	State		1		0
Contacts	N/O		closed	open	
	N/C		open	closed	





Position 0°



Push	Position	Top			
		Bottom			
	Location		Left		Right
	State		0		0
Contacts	N/O		open	open	
	N/C		closed	closed	

Position 45°



Push	Position	Top			
		Bottom			
	Location		Left		Right
	State		0		1
	Contacts	N/O			open
N/C		closed	open		

Technical Illustration

Dimensions

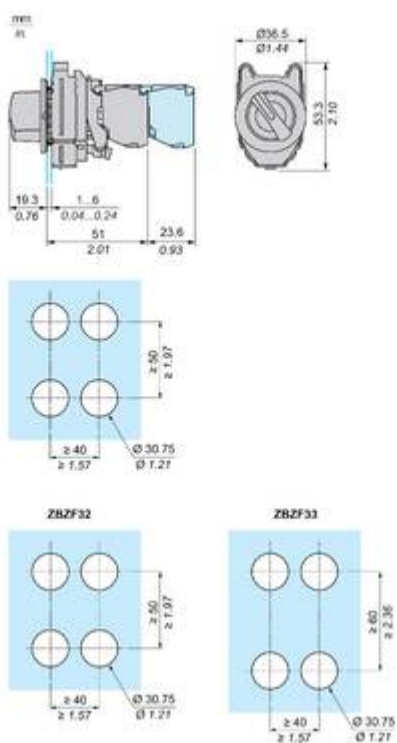

Image of product / Alternate images

Alternative

