

DALI 6-Key Push Button DALI Wall Switch

B29302003



Important: Read All Instructions Prior to Installation

Function introduction

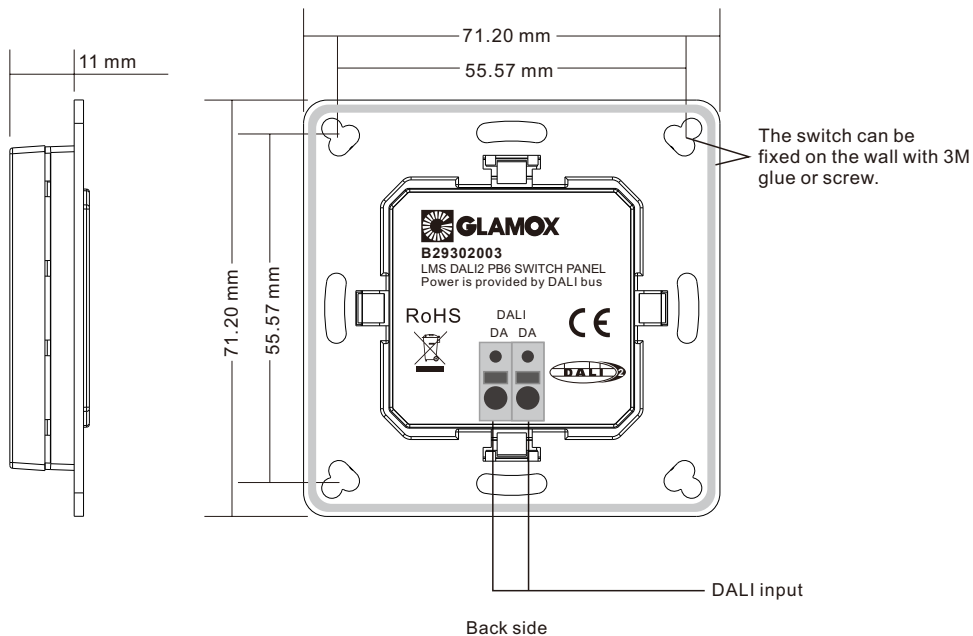
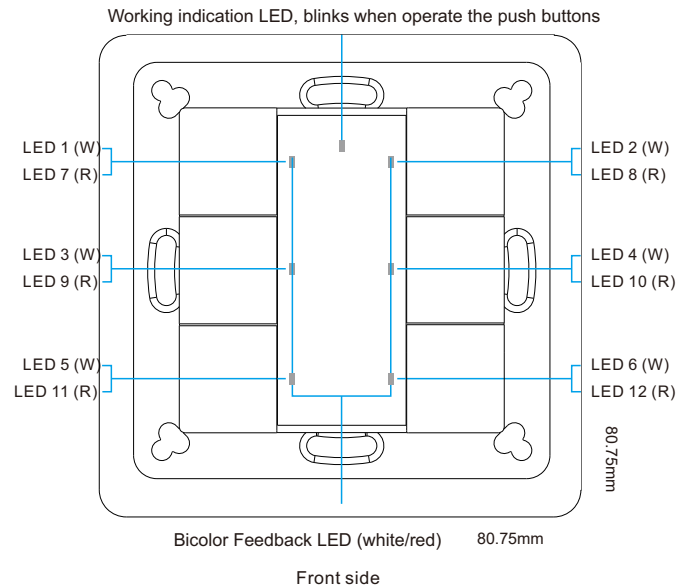

Product Features

- DALI-2 control device with 6 push buttons according to IEC62386-101, IEC62386-103, IEC62386-301 and IEC62386-332
- Supports feedback functionality, provides 12 LEDs
- Suitable for integration and in combination with DALI-2 compliant central control units
- Multimaster capable, multiple modules can be installed on the DALI- line
- DALI bus powered, no extra power supply required
- Easy configuration via DALI-2 compliant central controller USB interface
- Compatible with universal 55mm frames

Product Data

DALI Interface

Input Type	DALI
Marking	DA, DA
Input Voltage Range	12VDC - 22.5VDC (according IEC62368-101)
Typ. Current Consumption DALI (at 16.5V)	2mA
Max. Current Consumption DALI (Inrush Current at 22.5V)	10mA
Number of Addresses for DALI Control Devices	1
Number of Instances	6
Number of Feedback LED	12 programmable LEDs

General Data

Dimensions (L x W x H)	71.2mm x 71.2mm x 11mm
Mounting	Wall Mounting or on Conduit Box
Max. casing temperature Tc	75°C
Expected Life Time @Tc	50,000H
Protection Class	II in Intended Use
Protection Degree Housing	IP20
Protection Degree Terminals	IP20
Function	Configurable
Start-up Time	<150ms

Terminals

Connector Type	Push-In
Wire Size Solid Core	0.2 - 1.3 mm ² (AWG26 - AWG16)
Wire Size Fine Core	0.2 - 1.3 mm ² (AWG26 - AWG16)
Wire Size Using Wire End Ferrule	0.25 - 1.0 mm ²
Stripping Length	9 - 10 mm / 0.35 - 0.39 inch
Release Connector	Push Button

Environment Conditions

Storing Temperature	-20°C~+50°C
Working Ambient Temperature	-20°C~+50°C
Relative Humidity	8% - 80%

Standards

DALI	IEC62386-101:2014 IEC62386-103:2014 IEC62386-301 IEC62386-332
EMC	EN 61547 EN 50015 / IEC CISPR15
Safety	EN 61347-2-11 EN 61347-1
Markings	DALI-2, CE

Safety & Warnings

- DO NOT install on a powered DALI bus.
- DO NOT expose the device to moisture.

Application

Integration in a system with DALI-2 compliant central control unit, push buttons results in input notifications (event messages)

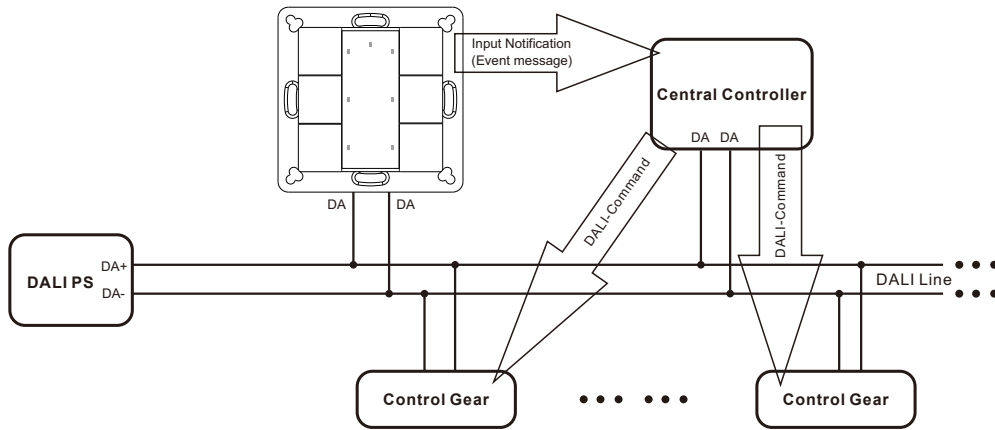

Application and Function

The DALI Switch can be used as input device for the integration in DALI-2 compliant central lighting control systems. In this mode each input (“instance”) informs about changes by using so called “input notifications”. These event-messages can be evaluated by other controllers on the DALI-line e.g. as trigger for commands sent to luminaires. The DALI-Switch provides 6 instances of type 1 (input device – push button).

Instance 1-6: Push Button, Instance Type 1 (according IEC62386-301, Input Devices – Push Button)

According to the standard the following INPUT NOTIFICATIONS are supported:

Event name	Event Information	Description
Button released	00 0000 0000b	The button is released
Button pressed	00 0000 0001b	The button is pressed
Short press	00 0000 0010b	The button is pressed and released, without being pressed quickly again (in case of double press enabled), or the button is pressed and quickly released (in case of double press is disabled)
Double press	00 0000 0101b	The button is pressed and released, quickly followed by another button press
Long press start	00 0000 1001b	The button is pressed without releasing it
Long press repeat	00 0000 1011b	Following a long press start condition the button is still pressed, the event occurs at regular intervals as long as the condition holds
Long press stop	00 0000 1100b	Following a long press start condition, the button is released
Button free	00 0000 1110b	The button has been stuck and is now released
Button stuck	00 0000 1111b	The button has been pressed for a very long time and is assumed stuck.

Additional instance parameters like event filter, event timings (short timer, double timer, repeat timer, stuck timer) can be configured according to IEC62386-301.

Push Button Function Label

Push button function label can be printed and customized, to better indicate whatever functions configured to the push buttons. Please contact sales person to ask for the available customizable button function file in Excel format, which will generate corresponding label image after selecting the desired function for each button, just print it and install as follows:

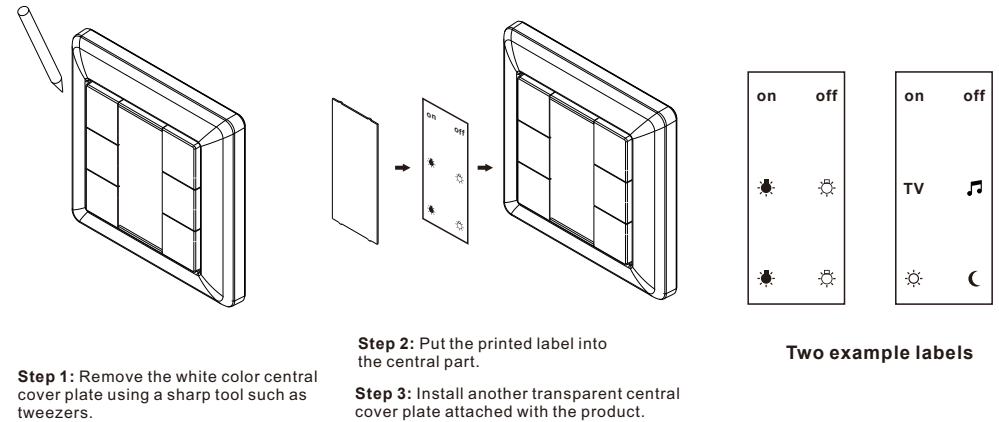

Feedback Functionality

This DALI wall switch supports feedback functionality, feedback is the means of informing the user about the system state, the supported feedback type by the switch is visible feedback using 12 LEDs.

The instance number of the 12 LEDs are as follows (according IEC62386-332, Input Devices – Feedback):

LEDs	Instance number
LED 1 (W)	0x20
LED 2 (W)	0x21
LED 3 (W)	0x22
LED 4 (W)	0x23
LED 5 (W)	0x24
LED 6 (W)	0x25
LED 7 (R)	0x26
LED 8 (R)	0x27
LED 9 (R)	0x28
LED 10 (R)	0x29
LED 11 (R)	0x30
LED 12 (R)	0x31

Commands to activate and stop feedback

Command Name	Opcode byte
ACTIVATE FEEDBACK	0x10
STOP FEEDBACK	0x11

Feedback variables and additional commands like feedbackActive, feedbackTiming, feedbackActiveBrightness, feedbackActiveColour, feedbackInactiveBrightness and feedbackInactiveColour can be configured according to IEC62386-332.

Installation

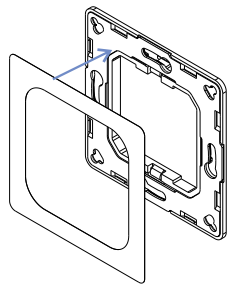

Method 1: Stick 3M glue on the back of the bracket and then stick the bracket to the wall

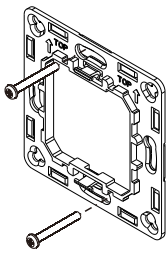

Method 2: Screw the bracket to the wall

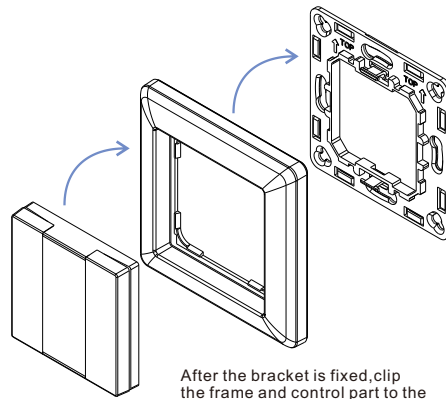

After the bracket is fixed, clip the frame and control part to the bracket in sequence

Mounting

The key part of this controller is a universal, standard switch element that can be integrated in numerous frames by different manufactures as below list:

BERKER	S1, B1, B3, B7 glass
GIRA	Standard55, E2, Event, Esprit
JUNG	A500, Aplus
MERTEN	M-smart, M-Arc, M-Plan
SCHNEIDER	Exxact
ELKO	L571