

---

Item no.: 771-9973/106-101  
Product description: CONNECTION WIRE; SOCKET - OPEN END; 3 POLE; 1 M;  
Coding P; made of PVC

---

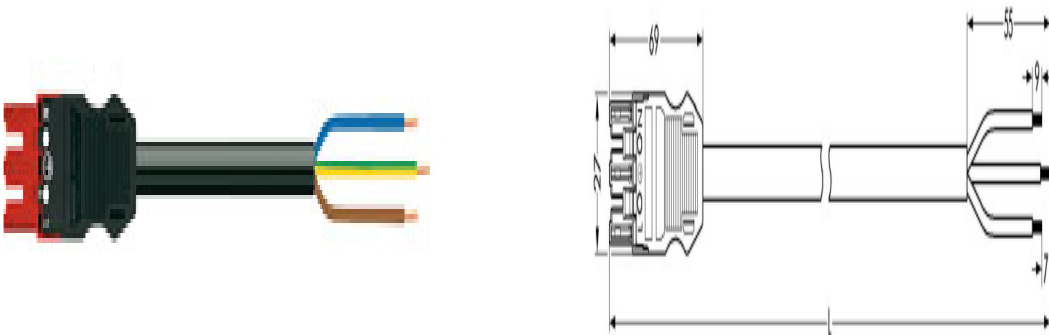

Packing unit 50 pieces

pole count	3
Cross section to [mm <sup>2</sup> ]	1,5 mm <sup>2</sup>
Cross section to [AWG]	16 AWG
Number of strands	3
Measured voltage EN	250 V
Measured shock voltage	4 kV
Pollution degree	3
Current intensity EN	16 A
Weight	116,27 g
Color	black

© WAGO Kontakttechnik GmbH & Co. KG

Specifications are subject to changes and errors may be expected