

Item no.: 771-9975/206-301
Product description: CONNECTION WIRE; PLUG - OPEN WIRE; 5 POLE; 3 m;
Coding P; made of PVC

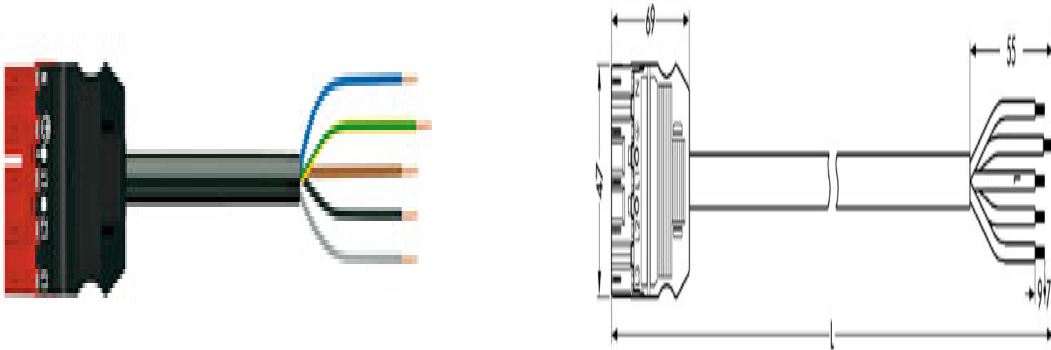

Packing unit 25 pieces

pole count	5
Cross section to [mm ²]	1,5 mm ²
Cross section to [AWG]	16 AWG
Number of strands	5
Measured voltage EN	400 V
Measured shock voltage	6 kV
Pollution degree	3
Current intensity EN	16 A
Weight	512,261 g
Color	black

© WAGO Kontakttechnik GmbH & Co. KG

Specifications are subject to changes and errors may be expected