

Item no.: 771-9975/207-201
Product description: CONNECTION WIRE; PLUG - OPEN WIRE; 5 POLE; 2 m;
Coding P; made of PVC

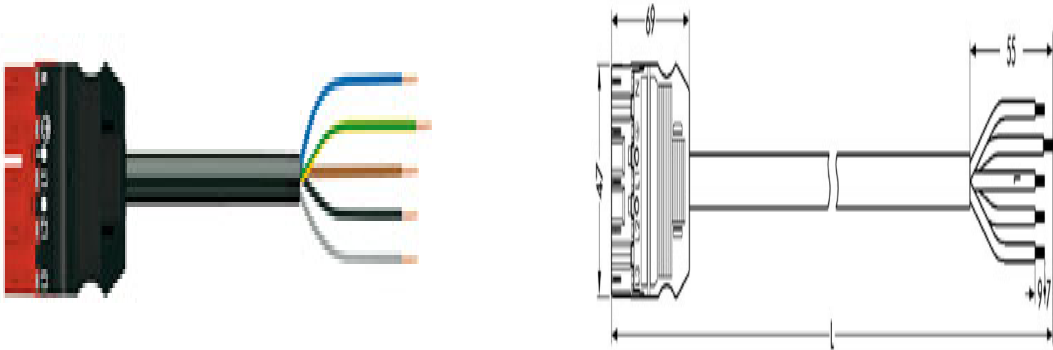

Packing unit 25 pieces

pole count	5
Cross section to [mm ²]	2,5 mm ²
Cross section to [AWG]	14 AWG
Number of strands	5
Measured voltage EN	400 V
Measured shock voltage	6 kV
Pollution degree	3
Current intensity EN	20 A
Weight	503,807 g
Color	black

© WAGO Kontakttechnik GmbH & Co. KG

Specifications are subject to changes and errors may be expected