

REV. COMB., AC3, 7.5KW/ 400V AC24V, 50/60HZ, 3-POLE, SZ S0
SCREW TERMINAL ELECTR. AND MECH. INTERLOCK 2NO
INTEGR.



Product brand name	SIRIUS
Product designation	Reversing contactor assembly
Product type designation	3RA23
Manufacturer's article number	<ul style="list-style-type: none"> • 1 of the supplied contactor 3RT2025-1AC20 • 2 of the supplied contactor 3RT2025-1AC20 • of the supplied RH assembly kit 3RA2923-2AA1

General technical data	
Size of contactor	S0
Product extension	<ul style="list-style-type: none"> • Auxiliary switch Yes
Insulation voltage	<ul style="list-style-type: none"> • with degree of pollution 3 rated value 690 V
Degree of pollution	3
Surge voltage resistance rated value	6 kV
Protection class IP	<ul style="list-style-type: none"> • on the front IP20
Shock resistance at rectangular impulse	<ul style="list-style-type: none"> • at AC 7,5g / 5 ms, 4,7g / 10 ms

<ul style="list-style-type: none"> • at DC 	10g / 5 ms, 7,5g / 10 ms
Shock resistance with sine pulse	
<ul style="list-style-type: none"> • at AC 	11,8g / 5 ms, 7,4g / 10 ms
<ul style="list-style-type: none"> • at DC 	15g / 5 ms, 10g / 10 ms
Mechanical service life (switching cycles)	
<ul style="list-style-type: none"> • of contactor typical 	10 000 000
<ul style="list-style-type: none"> • of the contactor with added auxiliary switch block typical 	10 000 000
Equipment marking	
<ul style="list-style-type: none"> • acc. to DIN EN 81346-2 	Q

Ambient conditions

Ambient temperature	
<ul style="list-style-type: none"> • during operation 	-25 ... +60 °C
<ul style="list-style-type: none"> • during storage 	-55 ... +80 °C

Main circuit

Number of poles for main current circuit	3
Number of NO contacts for main contacts	3
Number of NC contacts for main contacts	0
Operating voltage	
<ul style="list-style-type: none"> • at AC-3 rated value maximum 	690 V
Operating current	
<ul style="list-style-type: none"> • at AC-1 at 400 V <ul style="list-style-type: none"> — at ambient temperature 40 °C rated value — at ambient temperature 60 °C rated value 	40 A 35 A
<ul style="list-style-type: none"> • at AC-2 at 400 V rated value 	17 A
<ul style="list-style-type: none"> • at AC-3 <ul style="list-style-type: none"> — at 400 V rated value 	17 A
Operating current	
<ul style="list-style-type: none"> • at 1 current path at DC-1 <ul style="list-style-type: none"> — at 24 V rated value — at 110 V rated value 	35 A 4.5 A
<ul style="list-style-type: none"> • with 2 current paths in series at DC-1 <ul style="list-style-type: none"> — at 24 V rated value — at 110 V rated value 	35 A 35 A
<ul style="list-style-type: none"> • with 3 current paths in series at DC-1 <ul style="list-style-type: none"> — at 24 V rated value — at 110 V rated value 	35 A 35 A
Operating current	
<ul style="list-style-type: none"> • at 1 current path at DC-3 at DC-5 <ul style="list-style-type: none"> — at 24 V rated value — at 110 V rated value 	20 A 2.5 A

<ul style="list-style-type: none"> • with 2 current paths in series at DC-3 at DC-5 <ul style="list-style-type: none"> — at 24 V rated value — at 110 V rated value • with 3 current paths in series at DC-3 at DC-5 <ul style="list-style-type: none"> — at 24 V rated value — at 110 V rated value 	<p>35 A</p> <p>15 A</p> <p>35 A</p> <p>35 A</p>
No-load switching frequency	1 500 1/h
Operating frequency	
<ul style="list-style-type: none"> • at AC-1 maximum • at AC-2 maximum • at AC-3 maximum • at AC-4 maximum 	<p>1 000 1/h</p> <p>1 000 1/h</p> <p>1 000 1/h</p> <p>300 1/h</p>

Control circuit/ Control

Type of voltage of the control supply voltage	AC
Control supply voltage 1 at AC	
<ul style="list-style-type: none"> • at 50 Hz rated value • at 60 Hz rated value 	<p>24 V</p> <p>24 V</p>
Operating range factor control supply voltage rated value of magnet coil at AC	
<ul style="list-style-type: none"> • at 50 Hz • at 60 Hz 	<p>0.8 ... 1.1</p> <p>0.8 ... 1.1</p>
Apparent pick-up power of magnet coil at AC	
<ul style="list-style-type: none"> • at 50 Hz 	65 V·A
Inductive power factor with closing power of the coil	
<ul style="list-style-type: none"> • at 50 Hz 	0.82
Apparent holding power of magnet coil at AC	
<ul style="list-style-type: none"> • at 50 Hz 	8.5 V·A
Inductive power factor with the holding power of the coil	
<ul style="list-style-type: none"> • at 50 Hz 	0.25

Auxiliary circuit

Number of NO contacts	
<ul style="list-style-type: none"> • for auxiliary contacts <ul style="list-style-type: none"> — per direction of rotation — instantaneous contact 	<p>1</p> <p>2</p>
Operating current of auxiliary contacts at AC-12 maximum	10 A
Operating current of auxiliary contacts at AC-15	
<ul style="list-style-type: none"> • at 230 V • at 400 V 	<p>6 A</p> <p>3 A</p>
Operating current of auxiliary contacts at DC-13	
<ul style="list-style-type: none"> • at 24 V 	10 A

<ul style="list-style-type: none"> • at 60 V • at 110 V • at 220 V 	2 A 1 A 0.3 A
Contact reliability of auxiliary contacts	< 1 error per 100 million operating cycles

UL/CSA ratings

Full-load current (FLA) for three-phase AC motor	
<ul style="list-style-type: none"> • at 480 V rated value • at 600 V rated value 	14 A 17 A
Yielded mechanical performance [hp]	
<ul style="list-style-type: none"> • for single-phase AC motor <ul style="list-style-type: none"> — at 110/120 V rated value — at 230 V rated value • for three-phase AC motor <ul style="list-style-type: none"> — at 220/230 V rated value — at 460/480 V rated value — at 575/600 V rated value 	1 hp 3 hp 5 hp 10 hp 15 hp
Contact rating of auxiliary contacts according to UL	A600 / Q600

Short-circuit protection

Design of the fuse link	
<ul style="list-style-type: none"> • for short-circuit protection of the main circuit <ul style="list-style-type: none"> — with type of coordination 1 required — with type of assignment 2 required • for short-circuit protection of the auxiliary switch required 	gL/gG LV HRC 3NA, DIAZED 5SB, NEOZED 5SE: 63 A gL/gG LV HRC 3NA, DIAZED 5SB, NEOZED 5SE: 25 A fuse gL/gG: 10 A

Installation/ mounting/ dimensions

Mounting position	+/-180° rotation possible on vertical mounting surface; can be tilted forward and backward by +/- 22.5° on vertical mounting surface
Mounting type	screw and snap-on mounting onto 35 mm standard mounting rail
Height	101 mm
Width	90 mm
Depth	97 mm
Required spacing	
<ul style="list-style-type: none"> • with side-by-side mounting <ul style="list-style-type: none"> — forwards — Backwards — upwards — downwards — at the side • for grounded parts <ul style="list-style-type: none"> — forwards 	6 mm 0 mm 6 mm 6 mm 6 mm 6 mm

— Backwards	0 mm
— upwards	6 mm
— at the side	6 mm
— downwards	6 mm
• for live parts	
— forwards	6 mm
— Backwards	0 mm
— upwards	6 mm
— downwards	6 mm
— at the side	6 mm

Connections/Terminals

Type of electrical connection	
• for main current circuit	screw-type terminals
• for auxiliary and control current circuit	screw-type terminals
Type of connectable conductor cross-sections	
• for main contacts	
— solid	2x (1 ... 2.5 mm ²), 2x (2.5 ... 10 mm ²)
— single or multi-stranded	2x (1 ... 2,5 mm ²), 2x (2,5 ... 10 mm ²)
— finely stranded with core end processing	2x (1 ... 2.5 mm ²), 2x (2.5 ... 6 mm ²), 1x 10 mm ²
• at AWG conductors for main contacts	2x (16 ... 12), 2x (14 ... 8)
Type of connectable conductor cross-sections	
• for auxiliary contacts	
— single or multi-stranded	2x (0,5 ... 1,5 mm ²), 2x (0,75 ... 2,5 mm ²)
— finely stranded with core end processing	2x (0.5 ... 1.5 mm ²), 2x (0.75 ... 2.5 mm ²)
• at AWG conductors for auxiliary contacts	2x (20 ... 16), 2x (18 ... 14)



Safety related data



B10 value	
• with high demand rate acc. to SN 31920	1 000 000
Proportion of dangerous failures	
• with low demand rate acc. to SN 31920	40 %
• with high demand rate acc. to SN 31920	75 %
Failure rate [FIT]	
• with low demand rate acc. to SN 31920	100 FIT
T1 value for proof test interval or service life acc. to IEC 61508	20 y

Communication/ Protocol

Product function Bus communication	No
Protocol is supported	
• AS-interface protocol	No

Certificates/approvals

General Product Approval			Declaration of Conformity	Test Certificates	Marine / Shipping
 CSA	 UL		 EG-Konf.	Special Test Certificate	 ABS

Marine / Shipping					
 BUREAU VERITAS	 GL	 LRS	 PRS	 RMRS	 DNV-GL DNVGL.COM/AF

other	Railway	
Environmental Confirmations	Confirmation	Vibration and Shock

Further information

Information- and Downloadcenter (Catalogs, Brochures,...)

<http://www.siemens.com/industrial-controls/catalogs>

Industry Mall (Online ordering system)

<https://mall.industry.siemens.com/mall/en/en/Catalog/product?mlfb=3RA2325-8XB30-1AC2>

Cax online generator

<http://support.automation.siemens.com/WW/CAXorder/default.aspx?lang=en&mlfb=3RA2325-8XB30-1AC2>

Service&Support (Manuals, Certificates, Characteristics, FAQs,...)

<https://support.industry.siemens.com/cs/ww/en/ps/3RA2325-8XB30-1AC2>

Image database (product images, 2D dimension drawings, 3D models, device circuit diagrams, EPLAN macros, ...)

http://www.automation.siemens.com/bilddb/cax_de.aspx?mlfb=3RA2325-8XB30-1AC2&lang=en

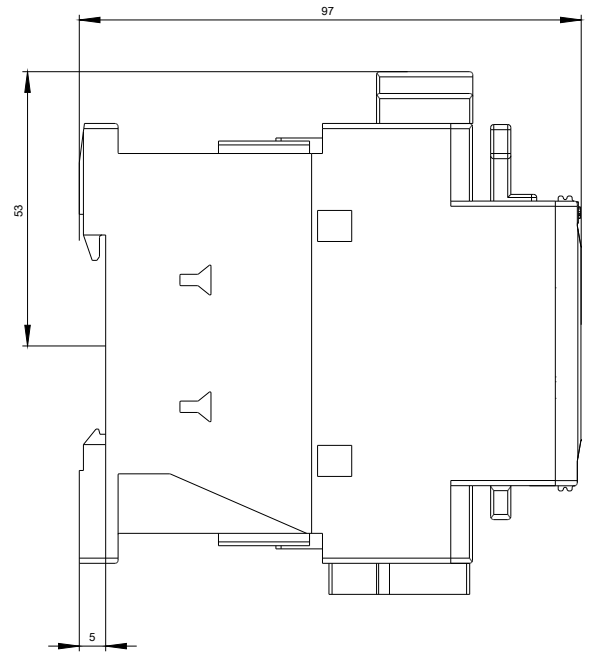
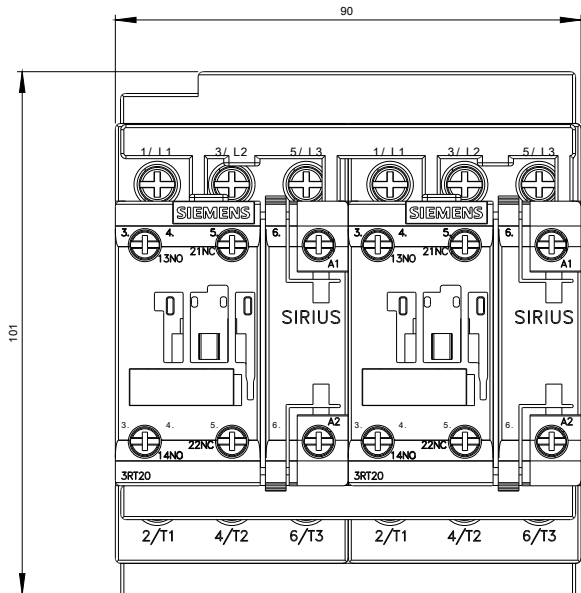

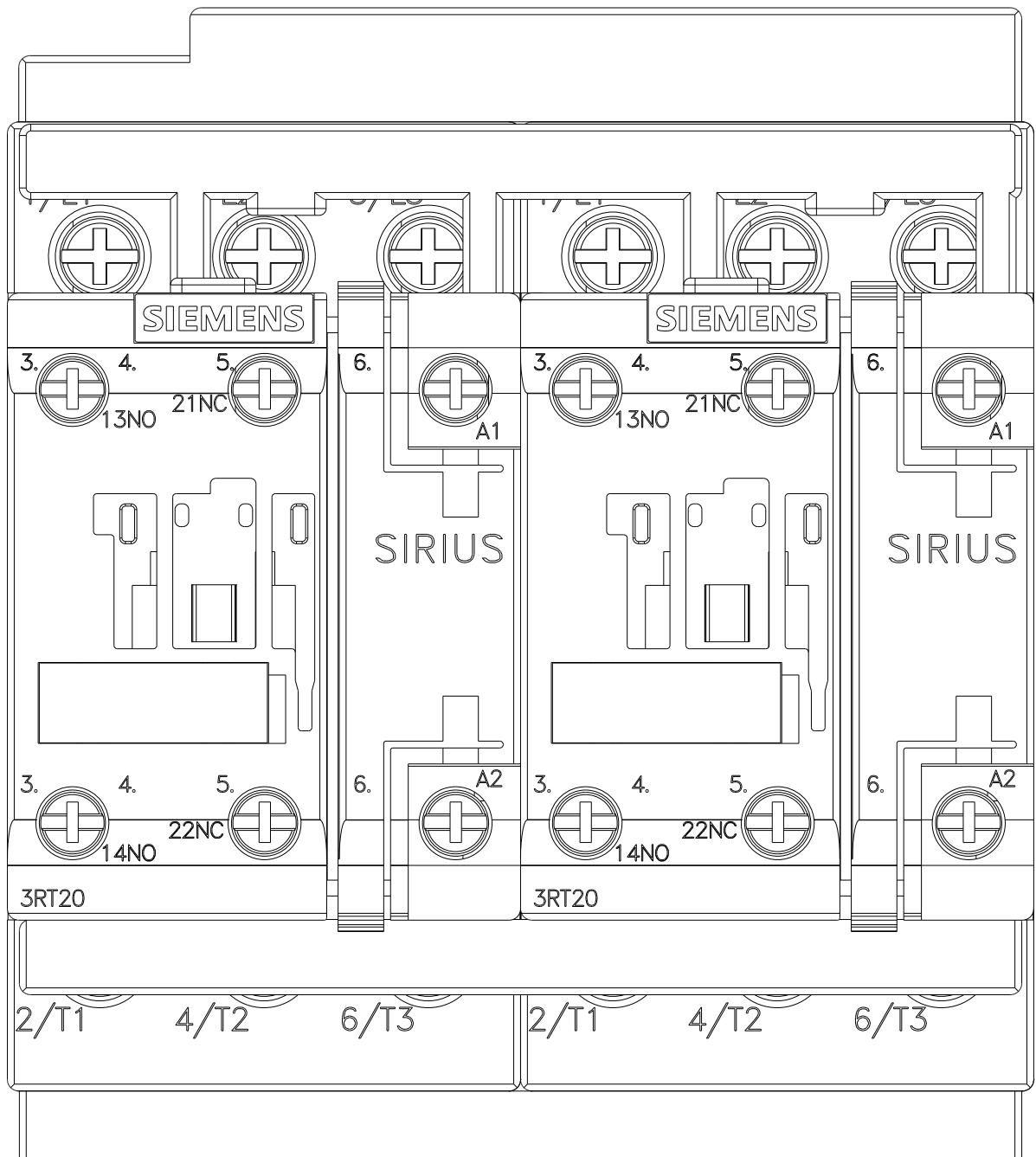

WENDEKOMBINATION BGR. S0

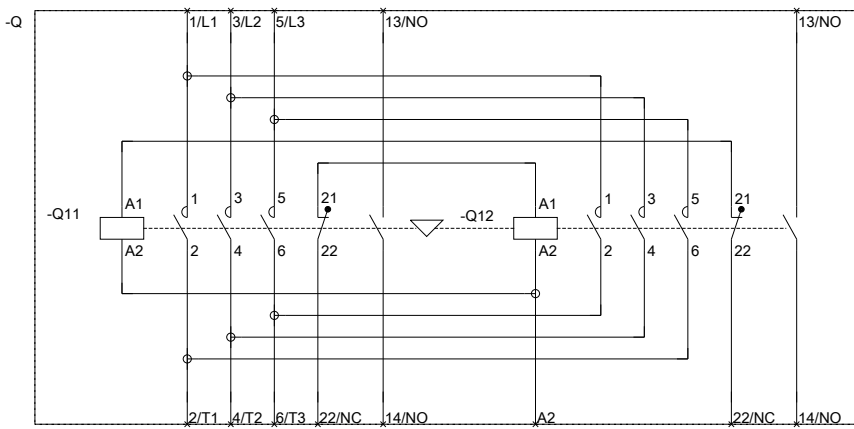

REVERSING COMB. SZ S0

last modified:

07/14/2017