

REV. COMB., AC3, 18.5KW/ 400V AC230V, 50/60HZ, 3-POLE, SZ  
S0 SCREW TERMINAL ELECTR. AND MECH. INTERLOCK 2NO  
INTEGR.



<b>Product brand name</b>	SIRIUS
<b>Product designation</b>	Reversing contactor assembly
<b>Product type designation</b>	3RA23
<b>Manufacturer's article number</b>	<ul style="list-style-type: none"> <li>• 1 of the supplied contactor <a href="#">3RT2028-1AL20</a></li> <li>• 2 of the supplied contactor <a href="#">3RT2028-1AL20</a></li> <li>• of the supplied RS assembly kit <a href="#">3RA2923-2AA1</a></li> </ul>

General technical data	
<b>Size of contactor</b>	S0
<b>Product extension</b>	Yes
<ul style="list-style-type: none"> <li>• Auxiliary switch</li> </ul>	
<b>Insulation voltage</b>	690 V
<ul style="list-style-type: none"> <li>• with degree of pollution 3 rated value</li> </ul>	
<b>Degree of pollution</b>	3
<b>Surge voltage resistance rated value</b>	6 kV
<b>Protection class IP</b>	IP20
<ul style="list-style-type: none"> <li>• on the front</li> </ul>	
<b>Shock resistance at rectangular impulse</b>	8,3g / 5 ms, 5,3g / 10 ms
<ul style="list-style-type: none"> <li>• at AC</li> </ul>	

<ul style="list-style-type: none"> <li>• at DC</li> </ul>	10g / 5 ms, 7,5g / 10 ms
<b>Shock resistance with sine pulse</b>	
<ul style="list-style-type: none"> <li>• at AC</li> </ul>	13,5g / 5 ms, 8,3g / 10 ms
<ul style="list-style-type: none"> <li>• at DC</li> </ul>	15g / 5 ms, 10g / 10 ms
<b>Mechanical service life (switching cycles)</b>	
<ul style="list-style-type: none"> <li>• of contactor typical</li> </ul>	10 000 000
<ul style="list-style-type: none"> <li>• of the contactor with added auxiliary switch block typical</li> </ul>	10 000 000
<b>Equipment marking</b>	
<ul style="list-style-type: none"> <li>• acc. to DIN EN 81346-2</li> </ul>	Q

### Ambient conditions

<b>Ambient temperature</b>	
<ul style="list-style-type: none"> <li>• during operation</li> </ul>	-25 ... +60 °C
<ul style="list-style-type: none"> <li>• during storage</li> </ul>	-55 ... +80 °C

### Main circuit

<b>Number of poles for main current circuit</b>	3
<b>Number of NO contacts for main contacts</b>	3
<b>Number of NC contacts for main contacts</b>	0
<b>Operating voltage</b>	
<ul style="list-style-type: none"> <li>• at AC-3 rated value maximum</li> </ul>	690 V
<b>Operating current</b>	
<ul style="list-style-type: none"> <li>• at AC-1 at 400 V <ul style="list-style-type: none"> <li>— at ambient temperature 40 °C rated value</li> <li>— at ambient temperature 60 °C rated value</li> </ul> </li> </ul>	50 A 45 A
<ul style="list-style-type: none"> <li>• at AC-2 at 400 V rated value</li> </ul>	38 A
<ul style="list-style-type: none"> <li>• at AC-3 <ul style="list-style-type: none"> <li>— at 400 V rated value</li> </ul> </li> </ul>	38 A
<b>Operating current</b>	
<ul style="list-style-type: none"> <li>• at 1 current path at DC-1 <ul style="list-style-type: none"> <li>— at 24 V rated value</li> <li>— at 110 V rated value</li> </ul> </li> </ul>	35 A 4.5 A
<ul style="list-style-type: none"> <li>• with 2 current paths in series at DC-1 <ul style="list-style-type: none"> <li>— at 24 V rated value</li> <li>— at 110 V rated value</li> </ul> </li> </ul>	35 A 35 A
<ul style="list-style-type: none"> <li>• with 3 current paths in series at DC-1 <ul style="list-style-type: none"> <li>— at 24 V rated value</li> <li>— at 110 V rated value</li> </ul> </li> </ul>	35 A 35 A
<b>Operating current</b>	
<ul style="list-style-type: none"> <li>• at 1 current path at DC-3 at DC-5 <ul style="list-style-type: none"> <li>— at 24 V rated value</li> <li>— at 110 V rated value</li> </ul> </li> </ul>	20 A 2.5 A

<ul style="list-style-type: none"> <li>with 2 current paths in series at DC-3 at DC-5 <ul style="list-style-type: none"> <li>at 24 V rated value</li> <li>at 110 V rated value</li> </ul> </li> <li>with 3 current paths in series at DC-3 at DC-5 <ul style="list-style-type: none"> <li>at 24 V rated value</li> <li>at 110 V rated value</li> </ul> </li> </ul>	35 A 15 A 35 A 35 A
<b>No-load switching frequency</b>	1 500 1/h
<b>Operating frequency</b>	
<ul style="list-style-type: none"> <li>at AC-1 maximum</li> <li>at AC-2 maximum</li> <li>at AC-3 maximum</li> <li>at AC-4 maximum</li> </ul>	1 000 1/h 1 000 1/h 1 000 1/h 300 1/h

### Control circuit/ Control

<b>Type of voltage of the control supply voltage</b>	AC
<b>Control supply voltage 1 at AC</b>	
<ul style="list-style-type: none"> <li>at 50 Hz rated value</li> <li>at 60 Hz rated value</li> </ul>	230 V 230 V
<b>Operating range factor control supply voltage rated value of magnet coil at AC</b>	
<ul style="list-style-type: none"> <li>at 50 Hz</li> <li>at 60 Hz</li> </ul>	0.8 ... 1.1 0.8 ... 1.1
<b>Apparent pick-up power of magnet coil at AC</b>	
<ul style="list-style-type: none"> <li>at 50 Hz</li> </ul>	77 V·A
<b>Inductive power factor with closing power of the coil</b>	
<ul style="list-style-type: none"> <li>at 50 Hz</li> </ul>	0.82
<b>Apparent holding power of magnet coil at AC</b>	
<ul style="list-style-type: none"> <li>at 50 Hz</li> </ul>	9.8 V·A
<b>Inductive power factor with the holding power of the coil</b>	
<ul style="list-style-type: none"> <li>at 50 Hz</li> </ul>	0.27

### Auxiliary circuit

<b>Number of NO contacts</b>	
<ul style="list-style-type: none"> <li>for auxiliary contacts <ul style="list-style-type: none"> <li>per direction of rotation</li> <li>instantaneous contact</li> </ul> </li> </ul>	1 2
<b>Operating current of auxiliary contacts at AC-12 maximum</b>	10 A
<b>Operating current of auxiliary contacts at AC-15</b>	
<ul style="list-style-type: none"> <li>at 230 V</li> <li>at 400 V</li> </ul>	6 A 3 A
<b>Operating current of auxiliary contacts at DC-13</b>	
<ul style="list-style-type: none"> <li>at 24 V</li> </ul>	10 A

<ul style="list-style-type: none"> <li>• at 60 V</li> <li>• at 110 V</li> <li>• at 220 V</li> </ul>	2 A 1 A 0.3 A
<b>Contact reliability of auxiliary contacts</b>	< 1 error per 100 million operating cycles

### UL/CSA ratings

<b>Full-load current (FLA) for three-phase AC motor</b>	
<ul style="list-style-type: none"> <li>• at 480 V rated value</li> <li>• at 600 V rated value</li> </ul>	34 A 27 A
<b>Yielded mechanical performance [hp]</b>	
<ul style="list-style-type: none"> <li>• for single-phase AC motor <ul style="list-style-type: none"> <li>— at 110/120 V rated value</li> <li>— at 230 V rated value</li> </ul> </li> <li>• for three-phase AC motor <ul style="list-style-type: none"> <li>— at 220/230 V rated value</li> <li>— at 460/480 V rated value</li> <li>— at 575/600 V rated value</li> </ul> </li> </ul>	3 hp 5 hp 10 hp 25 hp 25 hp
<b>Contact rating of auxiliary contacts according to UL</b>	A600 / Q600

### Short-circuit protection

<b>Design of the fuse link</b>	
<ul style="list-style-type: none"> <li>• for short-circuit protection of the main circuit <ul style="list-style-type: none"> <li>— with type of coordination 1 required</li> <li>— with type of assignment 2 required</li> </ul> </li> <li>• for short-circuit protection of the auxiliary switch required</li> </ul>	gL/gG NH 3NA, DIAZED 5SB, NEOZED 5SE: 125 A gL/gG NH 3NA, DIAZED 5SB, NEOZED 5SE: 50 A fuse gL/gG: 10 A

### Installation/ mounting/ dimensions

<b>Mounting position</b>	+/-180° rotation possible on vertical mounting surface; can be tilted forward and backward by +/- 22.5° on vertical mounting surface
<b>Mounting type</b>	screw and snap-on mounting onto 35 mm standard mounting rail
<b>Height</b>	101 mm
<b>Width</b>	90 mm
<b>Depth</b>	97 mm
<b>Required spacing</b>	
<ul style="list-style-type: none"> <li>• with side-by-side mounting <ul style="list-style-type: none"> <li>— forwards</li> <li>— Backwards</li> <li>— upwards</li> <li>— downwards</li> <li>— at the side</li> </ul> </li> <li>• for grounded parts <ul style="list-style-type: none"> <li>— forwards</li> </ul> </li> </ul>	6 mm 0 mm 6 mm 6 mm 6 mm 6 mm

— Backwards	0 mm
— upwards	6 mm
— at the side	6 mm
— downwards	6 mm
• for live parts	
— forwards	6 mm
— Backwards	0 mm
— upwards	6 mm
— downwards	6 mm
— at the side	6 mm

### Connections/Terminals

<b>Type of electrical connection</b>	
• for main current circuit	screw-type terminals
• for auxiliary and control current circuit	screw-type terminals
<b>Type of connectable conductor cross-sections</b>	
• for main contacts	
— solid	2x (1 ... 2.5 mm <sup>2</sup> ), 2x (2.5 ... 10 mm <sup>2</sup> )
— single or multi-stranded	2x (1 ... 2,5 mm <sup>2</sup> ), 2x (2,5 ... 10 mm <sup>2</sup> )
— finely stranded with core end processing	2x (1 ... 2.5 mm <sup>2</sup> ), 2x (2.5 ... 6 mm <sup>2</sup> ), 1x 10 mm <sup>2</sup>
• at AWG conductors for main contacts	2x (16 ... 12), 2x (14 ... 8)
<b>Type of connectable conductor cross-sections</b>	
• for auxiliary contacts	
— single or multi-stranded	2x (0,5 ... 1,5 mm <sup>2</sup> ), 2x (0,75 ... 2,5 mm <sup>2</sup> )
— finely stranded with core end processing	2x (0.5 ... 1.5 mm <sup>2</sup> ), 2x (0.75 ... 2.5 mm <sup>2</sup> )
• at AWG conductors for auxiliary contacts	2x (20 ... 16), 2x (18 ... 14)





### Safety related data





<b>B10 value</b>	
• with high demand rate acc. to SN 31920	1 000 000
<b>Proportion of dangerous failures</b>	
• with low demand rate acc. to SN 31920	40 %
• with high demand rate acc. to SN 31920	75 %
<b>Failure rate [FIT]</b>	
• with low demand rate acc. to SN 31920	100 FIT
<b>T1 value for proof test interval or service life acc. to IEC 61508</b>	20 y

### Communication/ Protocol

<b>Product function Bus communication</b>	No
<b>Protocol is supported</b>	
• AS-interface protocol	No

### Certificates/approvals

General Product Approval			Declaration of Conformity	Test Certificates	Marine / Shipping
 CSA	 UL		 EG-Konf.	<a href="#">Special Test Certificate</a>	 ABS

Marine / Shipping					
 BUREAU VERITAS	 GL	 LRS	 PRS	 RMRS	 DNV-GL DNVGL.COM/AF

other	Railway	
<a href="#">Environmental Confirmations</a>	<a href="#">Confirmation</a>	<a href="#">Vibration and Shock</a>

#### Further information

**Information- and Downloadcenter (Catalogs, Brochures,...)**

<http://www.siemens.com/industrial-controls/catalogs>

**Industry Mall (Online ordering system)**

<https://mall.industry.siemens.com/mall/en/en/Catalog/product?mlfb=3RA2328-8XB30-1AL2>

**Cax online generator**

<http://support.automation.siemens.com/WW/CAXorder/default.aspx?lang=en&mlfb=3RA2328-8XB30-1AL2>

**Service&Support (Manuals, Certificates, Characteristics, FAQs,...)**

<https://support.industry.siemens.com/cs/ww/en/ps/3RA2328-8XB30-1AL2>

**Image database (product images, 2D dimension drawings, 3D models, device circuit diagrams, EPLAN macros, ...)**

[http://www.automation.siemens.com/bilddb/cax\\_de.aspx?mlfb=3RA2328-8XB30-1AL2&lang=en](http://www.automation.siemens.com/bilddb/cax_de.aspx?mlfb=3RA2328-8XB30-1AL2&lang=en)

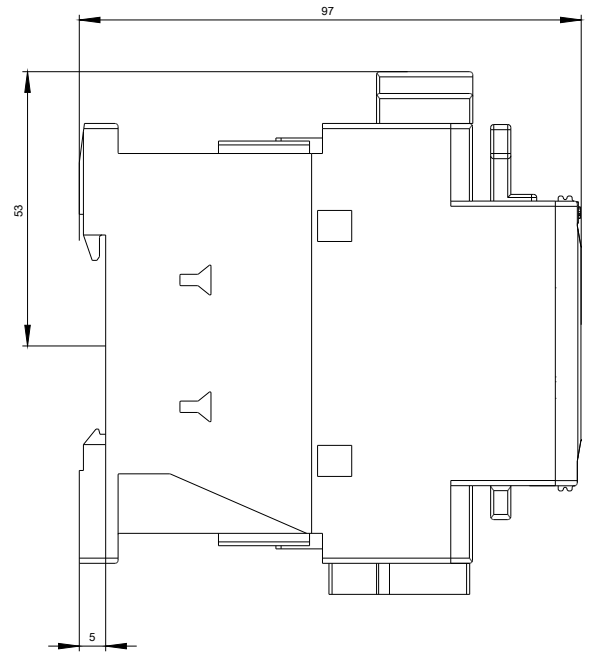
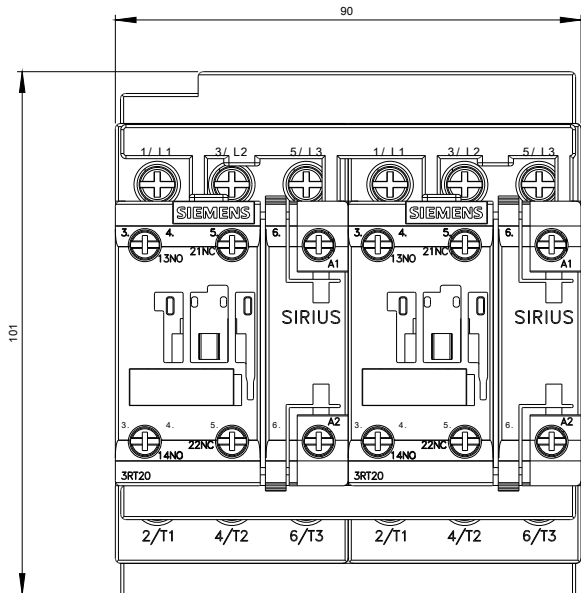

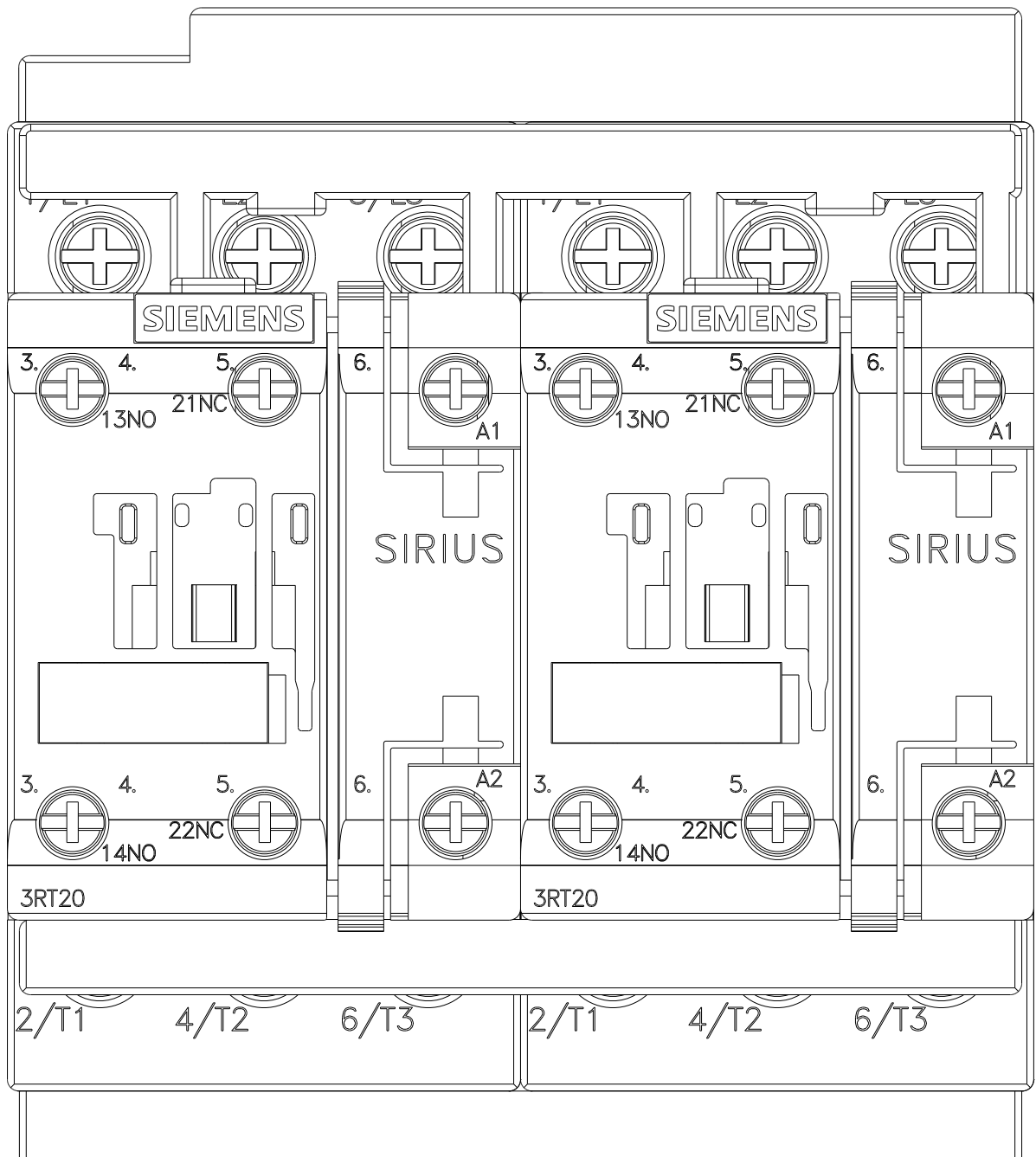



WENDEKOMBINATION BGR. S0

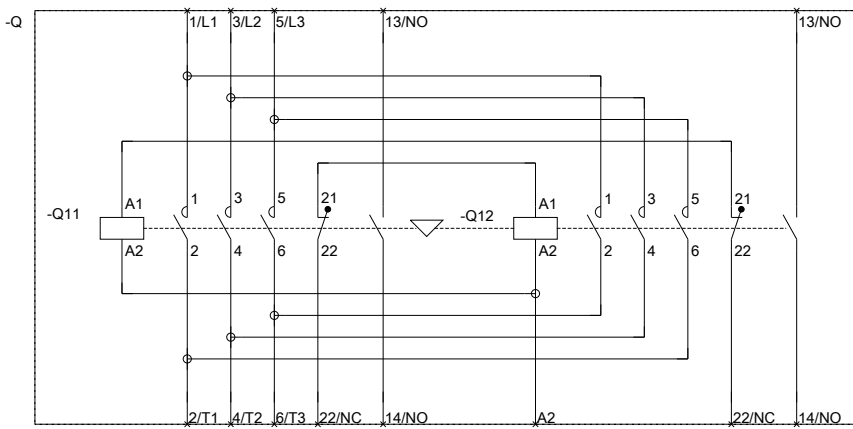

REVERSING COMB. SZ S0

last modified:

07/14/2017