

## PERFECT cable gland

500xxMxxPAzzzz

Dome nut	Polyamide PA6 V-2
Sealing ring	Polychloroprene-Nitrile rubber CR/NBR
Gland body	Polyamide PA6 V-2
Connecting thread	metric, as per EN 60423



### Properties

	<ul style="list-style-type: none"> <li>integrated anchorage</li> <li>wide sealing and clamping range</li> <li>sealing range and dome nut dimensions are identical to PERFECT Pg-series 50.0xx PAzzzz</li> <li>easy-to-install</li> </ul>
Temperature range (°C)	-20°C / +100°C (dynamic) -40°C (static, short term)
Protection grade	68 5
Test standard	EN 50262 UL 514B
VDE licence	40020902
UL / CSA-File	E140310
Comment	details about tests - see annex

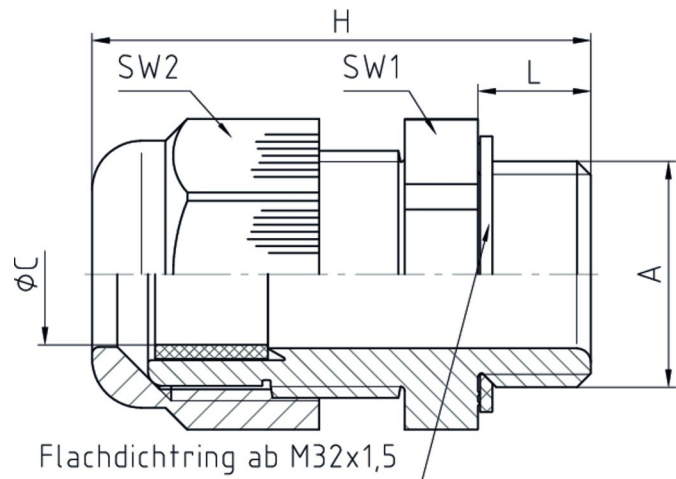

### Features

 RAL 9005

Connecting thread standard length

A	ØC	L	SW1	SW2	H		Part No.
M12x1,5	3 - 6,5	8	15	15	31	100	50007M12PASW
M16x1,5	5 - 10	8	22	22	37	100	50.011M16PA08/SW
M20x1,5	6 - 12	8	24	24	38,5	100	50.013M20PA08/SW
M20x1,5	10 - 14	8	27	27	40,5	50	50.016M20PA08/SW
M25x1,5	13 - 18	8	33	33	45	50	50.021M25PA08/SW
M32x1,5	18 - 25	10	42	42	52,5	25	50.029M32PA10/SW
M40x1,5	22 - 32	10	53	53	61,5	10	50.036M40PA10/SW
M50x1,5	30 - 38	12	60	60	67,5	5	50.042M50PA12/SW
M63x1,5	34 - 44	12	65	65	67	5	50.048M63PA12/SW

## Connecting thread long

A	ØC	L	SW1	SW2	H		Part No.
M12x1,5	3 - 6,5	8	15	15	31	100	50007M12PASW
M16x1,5	5 - 10	15	22	22	44	100	50011M16PASW
M20x1,5	6 - 12	11	24	24	41,5	100	50013M20PASW
M20x1,5	10 - 14	15	27	27	47,5	50	50016M20PASW
M25x1,5	13 - 18	15	33	33	52	50	50021M25PASW
M32x1,5	18 - 25	15	42	42	57	25	50029M32PASW
M40x1,5	22 - 32	18	53	53	69	10	50036M40PASW
M50x1,5	30 - 38	18	60	60	73,5	5	50042M50PASW
M63x1,5	34 - 44	18	65	65	73	5	50048M63PASW





RAL 7035

## Connecting thread standard length

A	ØC	L	SW1	SW2	H		Part No.
M12x1,5	3 - 6,5	8	15	15	31	100	50007M12PA7035
M16x1,5	5 - 10	8	22	22	37	100	50111M16PA08/7035
M20x1,5	6 - 12	8	24	24	38,5	100	50131M20PA08/7035
M20x1,5	10 - 14	8	27	27	40,5	50	50161M20PA08/7035
M25x1,5	13 - 18	8	33	33	45	50	50211M25PA08/7035
M32x1,5	18 - 25	10	42	42	52,5	25	50291M32PA10/7035
M40x1,5	22 - 32	10	53	53	61,5	10	50361M40PA10/7035
M50x1,5	30 - 38	12	60	60	67,5	5	50421M50PA12/7035
M63x1,5	34 - 44	12	65	65	67	5	50481M63PA12/7035

## Connecting thread long

A	ØC	L	SW1	SW2	H		Part No.
M12x1,5	3 - 6,5	8	15	15	31	100	50007M12PA7035
M16x1,5	5 - 10	15	22	22	44	100	50011M16PA7035
M20x1,5	6 - 12	11	24	24	41,5	100	50013M20PA7035
M20x1,5	10 - 14	15	27	27	47,5	50	50016M20PA7035
M25x1,5	13 - 18	15	33	33	52	50	50021M25PA7035

A	ØC	L	SW1	SW2	H		Part No.
M32x1,5	18 - 25	15	42	42	57	25	50029M32PA7035
M40x1,5	22 - 32	18	53	53	69	10	50036M40PA7035
M50x1,5	30 - 38	18	60	60	73,5	5	50042M50PA7035
M63x1,5	34 - 44	18	65	65	73	5	50048M63PA7035



RAL 7001

## Connecting thread standard length

A	ØC	L	SW1	SW2	H		Part No.
M12x1,5	3 - 6,5	8	15	15	31	100	50007M12PA
M16x1,5	5 - 10	8	22	22	37	100	50.011M16PA08
M20x1,5	6 - 12	8	24	24	38,5	100	50.013M20PA08
M20x1,5	10 - 14	8	27	27	40,5	50	50.016M20PA08
M25x1,5	13 - 18	8	33	33	45	50	50.021M25PA08
M32x1,5	18 - 25	10	42	42	52,5	25	50.029M32PA10
M40x1,5	22 - 32	10	53	53	61,5	10	50.036M40PA10
M50x1,5	30 - 38	12	60	60	67,5	5	50.042M50PA12
M63x1,5	34 - 44	12	65	65	67	5	50.048M63PA12

## Connecting thread long

A	ØC	L	SW1	SW2	H		Part No.
M12x1,5	3 - 6,5	8	15	15	31	100	50007M12PA
M16x1,5	5 - 10	15	22	22	44	100	50011M16PA
M20x1,5	6 - 12	11	24	24	41,5	100	50013M20PA
M20x1,5	10 - 14	15	27	27	47,5	50	50016M20PA
M25x1,5	13 - 18	15	33	33	52	50	50021M25PA
M32x1,5	18 - 25	15	42	42	57	25	50029M32PA
M40x1,5	22 - 32	18	53	53	69	10	50036M40PA
M50x1,5	30 - 38	18	60	60	73,5	5	50042M50PA
M63x1,5	34 - 44	18	65	65	73	5	50048M63PA