

PERFECT cable gland

50.6xx PAzzzz

Dome nut	Polyamide PA6 V-2
Sealing ring	Polychloroprene-Nitrile rubber CR/NBR
Gland body	Polyamide PA6 V-2
Connecting thread	metric, as per EN 60423



Properties

	<ul style="list-style-type: none"> integrated anchorage wide sealing and clamping range easy-to-install
Temperature range (°C)	-20°C / +100°C (dynamic) -40°C (static, short term)
Protection grade	68 5
Test standard	EN 50262 UL 514B
VDE licence	40020902
UL / CSA-File	E140310
GL T.A. Certificate	44 608 - 07 HH
Comment	details about tests - see annex

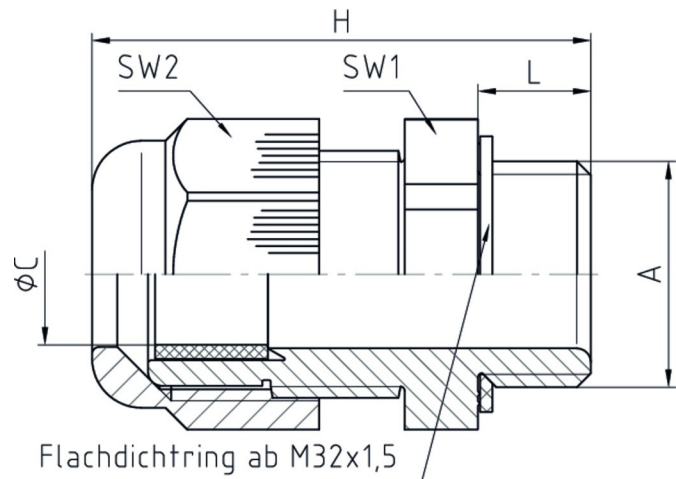

Features

 RAL 9005

Connecting thread standard length

A	ØC	L	SW1	SW2	H		Part No.
M12x1,5	3 - 6	8	15	15	31	100	50.612 PA/SW
M16x1,5	5 - 10	8	20	20	35,5	100	50.616 PA/SW
M20x1,5	8 - 13	8	24	24	36	100	50.620 PA/SW
M25x1,5	11 - 17	8	29	29	43	50	50.625 PA/SW
M32x1,5	15 - 21	10	36	36	50	25	50.632 PA/SW
M40x1,5	19 - 28	10	46	46	51	10	50.640 PA/SW
M50x1,5	27 - 35	12	55	55	61,5	5	50.650 PA/SW
M63x1,5	32 - 42	12	68	68	65,5	5	50.663 PA/SW

Connecting thread long

A	ØC	L	SW1	SW2	H		Part No.
M12x1,5	3 - 6	15	15	15	38	100	50.612 PA/SWL
M16x1,5	5 - 10	15	20	20	42,5	100	50.616 PA/SWL
M20x1,5	8 - 13	15	24	24	43	100	50.620 PA/SWL
M25x1,5	11 - 17	15	29	29	50	50	50.625 PA/SWL
M32x1,5	15 - 21	15	36	36	55	25	50.632 PA/SWL
M40x1,5	19 - 28	18	46	46	59	10	50.640 PA/SWL
M50x1,5	27 - 35	18	55	55	67,5	5	50.650 PA/SWL
M63x1,5	32 - 42	18	68	68	71,5	5	50.663 PA/SWL



RAL 7035

Connecting thread standard length

A	ØC	L	SW1	SW2	H		Part No.
M12x1,5	3 - 6	8	15	15	31	100	50.612 PA7035
M16x1,5	5 - 10	8	20	20	35,5	100	50.616 PA7035
M20x1,5	8 - 13	8	24	24	36	100	50.620 PA7035
M25x1,5	11 - 17	8	29	29	43	50	50.625 PA7035
M32x1,5	15 - 21	10	36	36	50	25	50.632 PA7035
M40x1,5	19 - 28	10	46	46	51	10	50.640 PA7035
M50x1,5	27 - 35	12	55	55	61,5	5	50.650 PA7035
M63x1,5	32 - 42	12	68	68	65,5	5	50.663 PA7035

Connecting thread long

A	ØC	L	SW1	SW2	H		Part No.
M12x1,5	3 - 6	15	15	15	38	100	50.612 PA7035L
M16x1,5	5 - 10	15	20	20	42,5	100	50.616 PA7035L
M20x1,5	8 - 13	15	24	24	43	100	50.620 PA7035L
M25x1,5	11 - 17	15	29	29	50	50	50.625 PA7035L
M32x1,5	15 - 21	15	36	36	55	25	50.632 PA7035L
M40x1,5	19 - 28	18	46	46	59	10	50.640 PA7035L
M50x1,5	27 - 35	18	55	55	67,5	5	50.650 PA7035L
M63x1,5	32 - 42	18	68	68	71,5	5	50.663 PA7035L



RAL 7001

Connecting thread standard length

A	ØC	L	SW1	SW2	H		Part No.
M12x1,5	3 - 6	8	15	15	31	100	50.612 PA7001
M16x1,5	5 - 10	8	20	20	35,5	100	50.616 PA7001
M20x1,5	8 - 13	8	24	24	36	100	50.620 PA7001
M25x1,5	11 - 17	8	29	29	43	50	50.625 PA7001
M32x1,5	15 - 21	10	36	36	50	25	50.632 PA7001
M40x1,5	19 - 28	10	46	46	51	10	50.640 PA7001
M50x1,5	27 - 35	12	55	55	61,5	5	50.650 PA7001
M63x1,5	32 - 42	12	68	68	65,5	5	50.663 PA7001

Connecting thread long

A	ØC	L	SW1	SW2	H		Part No.
M12x1,5	3 - 6	15	15	15	38	100	50.612 PA7001L
M16x1,5	5 - 10	15	20	20	42,5	100	50.616 PA7001L
M20x1,5	8 - 13	15	24	24	43	100	50.620 PA7001L
M25x1,5	11 - 17	15	29	29	50	50	50.625 PA7001L
M32x1,5	15 - 21	15	36	36	55	25	50.632 PA7001L
M40x1,5	19 - 28	18	46	46	59	10	50.640 PA7001L
M50x1,5	27 - 35	18	55	55	67,5	5	50.650 PA7001L
M63x1,5	32 - 42	18	68	68	71,5	5	50.663 PA7001L

with sealing ring and O-ring made of FKM on request