

Datablad | Artikkelnnummer: 2002-2701

Toetasjes rekkeklemme; Gjennom-/gjennom rekkeklemme; L/L; uten merkeholder; egnet for Ex e II anvendelser; for DIN-skinne 35 x 15 og 35 x 7,5; 2,5 mm²; Push-in CAGE CLAMP®; 2,50 mm²; grå

www.wago.com/2002-2701

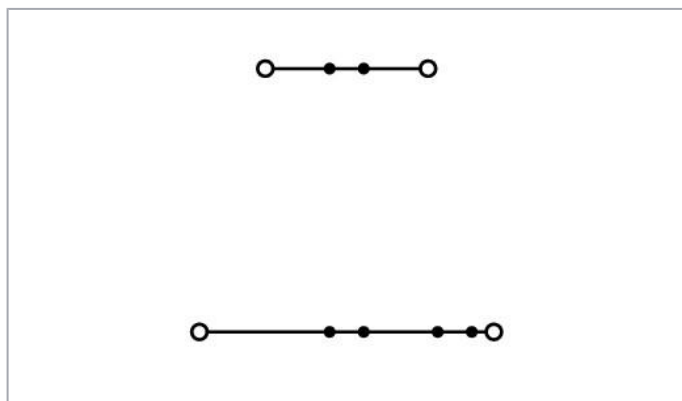
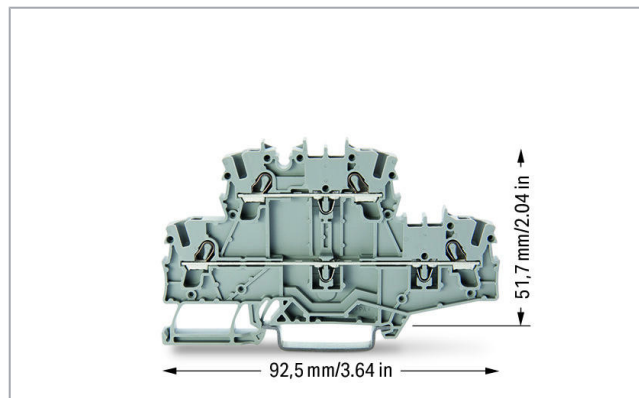
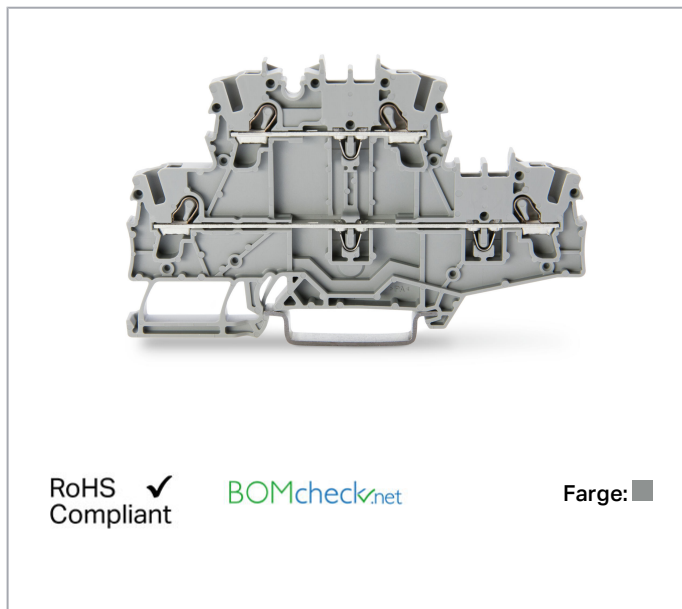

Data

Electrical data

Ratings per IEC/EN 60664-1

Ratings per	IEC/EN 60947-7-1
Rated voltage (III / 3)	800 V
Rated impulse voltage (III / 3)	8 kV
Rated current	24 A

Med forbehold om endringer. Vær også oppmerksom på ytterligere produktdokumentasjon!

WAGO Norge AS
Jerikoveien 20
1067 Oslo
Tel.: +47 22 30 94 60 | Fax: +47 22 30 94 51
Email: info.no@wago.com

Har du spørsmål om våre produkter?
Vi tar alltid gjerne imot di samtale på +49 (571) 887-44222.



Rated current (2)	28 A
Legend (ratings)	(III / 3) $\hat{=}$ Overvoltage category III / Pollution degree 3

Ex information

Rated voltage EN (Ex e II)	550 V
Rated current (Ex e II)	17,5 A
Rated current (Ex e II) with jumper	17 A

Connection data

Connection technology	Push-in CAGE CLAMP [®]
Number of connection points (connection type)	2
Actuation type	Push-in Operating tool
Connectable conductor materials	Copper
Nominal cross section	2,5 mm ²
Solid conductor	0,25 ... 4 mm ² / 22 ... 12 AWG
Solid conductor, push-in termination	0,75 ... 4 mm ² / 18 ... 12 AWG
Fine-stranded conductor	0,25 ... 4 mm ² / 22 ... 12 AWG
Fine-stranded conductor with ferrule with plastic collar	1 ... 2,5 mm ² / 18 ... 14 AWG
Fine-stranded conductor with ferrule, push-in termination, from	1 ... 2,5 mm ² / 18 ... 14 AWG
Strip length	10 ... 12 mm / 0.39 ... 0.47 inch
Number of connection points	2
Total number of connection points	4
Total number of potentials	2
Number of levels	2
Type of wiring	Front-entry wiring
Note (conductor cross-section)	Depending on the conductor characteristic, a conductor with a smaller cross-section can also be inserted via push-in termination.

Geometrical Data

Width	5,2 mm / 0.205 inch
Høyde fra øverste kant av DIN-skinne	51,7 mm / 2.035 inch
Depth	92,5 mm / 3.642 inch

Mechanical data

Potential marking	L/L
Design	horizontal

Med forbehold om endringer. Vær også oppmerksom på ytterligere produktdokumentasjon!

WAGO Norge AS
Jerikoveien 20
1067 Oslo
Tel.: +47 22 30 94 60 | Fax: +47 22 30 94 51
Email: info.no@wago.com

Har du spørsmål om våre produkter?
Vi tar alltid gjerne imot di samtale på +49 (571) 887-44222.

Type of mounting	DIN-35 rail
Marking level	Center/side marking

Material Data

Color	grå
Insulating material	Polyamide (PA66)
Weight	12,5 g

Commercial data

Packaging type	BOX
Country of origin	DE
GTIN	4055143622493
Customs tariff number	85369010000

Godkjenninger / sertifikater

EX-godkjenninger

Logo	Godkjenning	Ytterligere godkjenningstekst	Sertifikatnavn
	AEx Underwriters Laboratories Inc.	UL 60079	20190704-E185892
	ATEX Physikalisch Technische Bundesanstalt	IEC 60079-0	PTB 18 ATEX 1005 U (II 2 G Ex eb IIC Gb bzw. I M 2 Ex eb I Mb)
	CCCEX CQST/CNEx	CNCA-C23-01	2020312313000169
	IECEX Physikalisch Technische Bundesanstalt	IEC 60079	IECEX PTB 18.0012 U (Ex eb IIC Gb and Ex eb I Mb)

Landspesifikke godkjenninger

Logo	Godkjenning	Ytterligere godkjenningstekst	Sertifikatnavn
	CCA DEKRA Certification B.V.	EN 60947	NTR NL 7730

Med forbehold om endringer. Vær også oppmerksom på ytterligere produktdokumentasjon!

WAGO Norge AS
Jerikoveien 20
1067 Oslo
Tel.: +47 22 30 94 60 | Fax: +47 22 30 94 51
Email: info.no@wago.com

Har du spørsmål om våre produkter?
Vi tar alltid gjerne imot di samtale på +49 (571) 887-44222.



KEMA/KEUR
DEKRA Certification B.V.

EN 60947

71-107687







UL-godkjenninger

Logo	Godkjenning	Ytterligere godkjenningstekst	Sertifikatnavn
	cURus Underwriters Laboratories Inc.	UL 1059	20190731- E45172

Motpart

Kompatible produkter















End plate

	Elementnr.: 209-192 Separator for Ex e/Ex i anvendelser; 3 mm tykk; 125,5 mm bred; oransje	www.wago.com/209-192
Marking accessories		
	Elementnr.: 2002-121 Adapter; grå	www.wago.com/2002-121
	Elementnr.: 2002-161 Adapter; grå	www.wago.com/2002-161
	Elementnr.: 2009-110 Merkelister; for Smart Printer; på rull; not stretchable; vanlig; klikk-på type; hvit	www.wago.com/2009-110
	Elementnr.: 2009-115 WMB-inline; for Smart Printer; 1500 deler på rull; strekkbar 5 til 5,2 mm; vanlig; klikk-på type; hvit	www.wago.com/2009-115
	Elementnr.: 2009-115/000-002 WMB-inline; for Smart Printer; 1500 deler på rull; strekkbar 5 til 5,2 mm; vanlig; klikk-på type; gul	www.wago.com/2009-115/000-002

Med forbehold om endringer. Vær også oppmerksom på ytterligere produktdokumentasjon!

WAGO Norge AS
Jerikoveien 20
1067 Oslo
Tel.: +47 22 30 94 60 | Fax: +47 22 30 94 51
Email: info.no@wago.com















Har du spørsmål om våre produkter?
Vi tar alltid gjerne imot di samtale på +49 (571) 887-44222.

	Elementnr.: 2009-115/000-005 WMB-inline; for Smart Printer; 1500 deler på rull; strekkbar 5 til 5,2 mm; vanlig; klikk-på type; rød	www.wago.com/2009-115/000-005
	Elementnr.: 2009-115/000-006 WMB-inline; for Smart Printer; 1500 deler på rull; strekkbar 5 til 5,2 mm; vanlig; klikk-på type; blå	www.wago.com/2009-115/000-006
	Elementnr.: 2009-115/000-007 WMB-inline; for Smart Printer; 1500 deler på rull; strekkbar 5 til 5,2 mm; vanlig; klikk-på type; grå	www.wago.com/2009-115/000-007
	Elementnr.: 2009-115/000-012 WMB-inline; for Smart Printer; 1500 deler på rull; strekkbar 5 til 5,2 mm; vanlig; klikk-på type; oransje	www.wago.com/2009-115/000-012
	Elementnr.: 2009-115/000-017 WMB-inline; for Smart Printer; 1500 deler på rull; strekkbar 5 til 5,2 mm; vanlig; klikk-på type; lysegrønn	www.wago.com/2009-115/000-017
	Elementnr.: 2009-115/000-023 WMB-inline; for Smart Printer; 1500 deler på rull; strekkbar 5 til 5,2 mm; vanlig; klikk-på type; grønn	www.wago.com/2009-115/000-023
	Elementnr.: 2009-115/000-024 WMB-inline; for Smart Printer; 1500 deler på rull; strekkbar 5 til 5,2 mm; vanlig; klikk-på type; fiolett	www.wago.com/2009-115/000-024
	Elementnr.: 2009-145 Mini-WSB Inline; for Smart Printer; 1700 deler på rull; strekkbar 5 til 5,2 mm; vanlig; klikk-på type; hvit	www.wago.com/2009-145
	Elementnr.: 2009-145/000-002 Mini-WSB Inline; for Smart Printer; 1700 deler på rull; strekkbar 5 til 5,2 mm; vanlig; klikk-på type; gul	www.wago.com/2009-145/000-002
	Elementnr.: 2009-145/000-005 Mini-WSB Inline; for Smart Printer; 1700 deler på rull; strekkbar 5 til 5,2 mm; vanlig; klikk-på type; rød	www.wago.com/2009-145/000-005
	Elementnr.: 2009-145/000-006 Mini-WSB Inline; for Smart Printer; 1700 deler på rull; strekkbar 5 til 5,2 mm; vanlig; klikk-på type; blå	www.wago.com/2009-145/000-006
	Elementnr.: 2009-145/000-007 Mini-WSB Inline; for Smart Printer; 1700 deler på rull; strekkbar 5 til 5,2 mm; vanlig; klikk-på type; grå	www.wago.com/2009-145/000-007
	Elementnr.: 2009-145/000-012 Mini-WSB Inline; for Smart Printer; 1700 deler på rull; strekkbar 5 til 5,2 mm; vanlig; klikk-på type; oransje	www.wago.com/2009-145/000-012
	Elementnr.: 2009-145/000-023 Mini-WSB Inline; for Smart Printer; 1700 deler på rull; strekkbar 5 til 5,2 mm; vanlig; klikk-på type; grønn	www.wago.com/2009-145/000-023

Med forbehold om endringer. Vær også oppmerksom på ytterligere produktdokumentasjon!

WAGO Norge AS
Jerikoveien 20
1067 Oslo
Tel.: +47 22 30 94 60 | Fax: +47 22 30 94 51
Email: info.no@wago.com

Har du spørsmål om våre produkter?
Vi tar alltid gjerne imot di samtale på +49 (571) 887-44222.

	Elementnr.: 2009-145/000-024 Mini-WSB Inline; for Smart Printer; 1700 deler på rull; strekkbar 5 til 5,2 mm; vanlig; klikk-på type; fiolett	www.wago.com/2009-145/000-024
	Elementnr.: 2009-191 Gruppemerkeholder	www.wago.com/2009-191
	Elementnr.: 2009-192 Gruppemerkeholder	www.wago.com/2009-192
	Elementnr.: 2009-193 Gruppemerkeholder	www.wago.com/2009-193
	Elementnr.: 2009-198 Adapter; grå	www.wago.com/2009-198
	Elementnr.: 248-501 Minityr WSB hurtigmerkesystem; vanlig; Merkebredde 5 mm; 10 lister med 10 merker per kort	www.wago.com/248-501
	Elementnr.: 248-501/000-002 Mini-WSB merkekort; som kort; not stretchable; vanlig; klikk-på type; gul	www.wago.com/248-501/000-002
	Elementnr.: 248-501/000-005 Mini-WSB merkekort; som kort; not stretchable; vanlig; klikk-på type; rød	www.wago.com/248-501/000-005
	Elementnr.: 248-501/000-006 Mini-WSB merkekort; som kort; not stretchable; vanlig; klikk-på type; blå	www.wago.com/248-501/000-006
	Elementnr.: 248-501/000-007 Mini-WSB merkekort; som kort; not stretchable; vanlig; klikk-på type; grå	www.wago.com/248-501/000-007
	Elementnr.: 248-501/000-012 Mini-WSB merkekort; som kort; not stretchable; vanlig; klikk-på type; oransje	www.wago.com/248-501/000-012
	Elementnr.: 248-501/000-017 Mini-WSB merkekort; som kort; not stretchable; vanlig; klikk-på type; lysegrønn	www.wago.com/248-501/000-017
	Elementnr.: 248-501/000-023 Mini-WSB merkekort; som kort; not stretchable; vanlig; klikk-på type; grønn	www.wago.com/248-501/000-023
	Elementnr.: 248-501/000-024 Mini-WSB merkekort; som kort; not stretchable; vanlig; klikk-på type; fiolett	www.wago.com/248-501/000-024
	Elementnr.: 793-501 WMB-merkekort; som kort; not stretchable; vanlig; klikk-på type; hvit	www.wago.com/793-501

Med forbehold om endringer. Vær også oppmerksom på ytterligere produktdokumentasjon!

WAGO Norge AS
Jerikoveien 20
1067 Oslo
Tel.: +47 22 30 94 60 | Fax: +47 22 30 94 51
Email: info.no@wago.com

Har du spørsmål om våre produkter?
Vi tar alltid gjerne imot di samtale på +49 (571) 887-44222.



Elementnr.: 793-501/000-002
WMB-merkekort; som kort; not stretchable; vanlig; klikk-på type; gul

www.wago.com/793-501/000-002



Elementnr.: 793-501/000-005
WMB-merkekort; som kort; not stretchable; vanlig; klikk-på type; rød

www.wago.com/793-501/000-005



Elementnr.: 793-501/000-006
WMB-merkekort; som kort; not stretchable; vanlig; klikk-på type; blå

www.wago.com/793-501/000-006



Elementnr.: 793-501/000-007
WMB-merkekort; som kort; not stretchable; vanlig; klikk-på type; grå

www.wago.com/793-501/000-007



Elementnr.: 793-501/000-012
WMB-merkekort; som kort; not stretchable; vanlig; klikk-på type; oransje

www.wago.com/793-501/000-012



Elementnr.: 793-501/000-017
WMB-merkekort; som kort; not stretchable; vanlig; klikk-på type; lysegrønn

www.wago.com/793-501/000-017



Elementnr.: 793-501/000-023
WMB-merkekort; som kort; not stretchable; vanlig; klikk-på type; grønn

www.wago.com/793-501/000-023



Elementnr.: 793-501/000-024
WMB-merkekort; som kort; not stretchable; vanlig; klikk-på type; fiolett

www.wago.com/793-501/000-024



Elementnr.: 793-5501
WMB-merkekort; som kort; for klembredde 5 til 17,5 mm; strekkbar 5 til 5,2 mm; vanlig; klikk-på type; hvit

www.wago.com/793-5501



Elementnr.: 793-5501/000-002
WMB-merkekort; som kort; for klembredde 5 til 17,5 mm; strekkbar 5 til 5,2 mm; vanlig; klikk-på type; gul

www.wago.com/793-5501/000-002



Elementnr.: 793-5501/000-005
WMB-merkekort; som kort; for klembredde 5 til 17,5 mm; strekkbar 5 til 5,2 mm; vanlig; klikk-på type; rød

www.wago.com/793-5501/000-005



Elementnr.: 793-5501/000-006
WMB-merkekort; som kort; for klembredde 5 til 17,5 mm; strekkbar 5 til 5,2 mm; vanlig; klikk-på type; blå

www.wago.com/793-5501/000-006



Elementnr.: 793-5501/000-007
WMB-merkekort; som kort; for klembredde 5 til 17,5 mm; strekkbar 5 til 5,2 mm; vanlig; klikk-på type; grå









www.wago.com/793-5501/000-007

Elementnr.: 793-5501/000-012

















Med forbehold om endringer. Vær også oppmerksom på ytterligere produktdokumentasjon!

WAGO Norge AS
Jerikoveien 20
1067 Oslo
Tel.: +47 22 30 94 60 | Fax: +47 22 30 94 51
Email: info.no@wago.com

Har du spørsmål om våre produkter?
Vi tar alltid gjerne imot di samtale på +49 (571) 887-44222.

	WMB-merkekort; som kort; for klembredde 5 til 17,5 mm; strekkbar 5 til 5,2 mm; vanlig; klikk-på type; oransje	www.wago.com/793-5501/000-012
	Elementnr.: 793-5501/000-014 WMB-merkekort; som kort; for klembredde 5 til 17,5 mm; strekkbar 5 til 5,2 mm; vanlig; klikk-på type; brun	www.wago.com/793-5501/000-014
	Elementnr.: 793-5501/000-017 WMB-merkekort; som kort; for klembredde 5 til 17,5 mm; strekkbar 5 til 5,2 mm; vanlig; klikk-på type; grønn	www.wago.com/793-5501/000-017
	Elementnr.: 793-5501/000-023 WMB-merkekort; som kort; for klembredde 5 til 17,5 mm; strekkbar 5 til 5,2 mm; vanlig; klikk-på type; lysegrønn	www.wago.com/793-5501/000-023
	Elementnr.: 793-5501/000-024 WMB-merkekort; som kort; for klembredde 5 til 17,5 mm; strekkbar 5 til 5,2 mm; vanlig; klikk-på type; fiolett	www.wago.com/793-5501/000-024
check		
	Elementnr.: 2002-611 TOPJOB®S L-type-testpluggmodul; modulær; 1-polet; 2,50 mm ² ; grå	www.wago.com/2002-611
	Elementnr.: 2002-649 TOPJOB®S L-type avstandsstykke; modulær; f.eks. for brokobling av sammenkoblede rekkeklemmer; grå	www.wago.com/2002-649
	Elementnr.: 2009-174 Testpluggadapter; for testplugg 4 mm Ø; for testing av TOPJOB®S skinnemonterte rekkeklemmer; grå	www.wago.com/2009-174
	Elementnr.: 2009-182 Testkontakt; for maks. 2,5 mm ² ; tilkopling uten verktøy for individuelle testledninger 0,08 - 2,5 mm ² ; grå	www.wago.com/2009-182
Insulation stop		
	Elementnr.: 2002-171 Isolasjonsstopp; 0,25–0,5 mm ² ; 5 deler/list; lysegrå	www.wago.com/2002-171
	Elementnr.: 2002-172 Isolasjonsstopp; 0,75–1 mm ² ; 5 deler/list; mørkegrå	www.wago.com/2002-172
Protective Warning Marker		
	Elementnr.: 2002-115 Beskyttende advarselsmerke; med høyspenningssymbol, sort; for 5 rekkeklemmer; gul	www.wago.com/2002-115
Carrier rail		
	Elementnr.: 210-112 Bæreskinne i stål; 35 x 7,5 mm; 1 mm tykk; 2 m lang; med spor; i henhold til EN 60715; "Hullbredde 25 mm; sølvfarget	www.wago.com/210-112
	Elementnr.: 210-113 Bæreskinne i stål; 35 x 7,5 mm; 1 mm tykk; 2 m lang; uten spor; i henhold til EN 60715; sølvfarget	www.wago.com/210-113















Med forbehold om endringer. Vær også oppmerksom på ytterligere produktdokumentasjon!

	Elementnr.: 210-114 Bæreskinne i stål; 35 x 15 mm; 1,5 mm tykk; 2 m lang; uten spor; likner EN 60715; sølvfarget	www.wago.com/210-114
	Elementnr.: 210-115 Bæreskinne i stål; 35 x 7,5 mm; 1 mm tykk; 2 m lang; med spor; i henhold til EN 60715; "Hullbredde 18 mm; sølvfarget	www.wago.com/210-115
	Elementnr.: 210-118 Bæreskinne i stål; 35 x 15 mm; 2,3 mm tykk; 2 m lang; uten spor; i henhold til EN 60715; sølvfarget	www.wago.com/210-118
	Elementnr.: 210-196 Bæreskinne i aluminium; 35 x 8,2 mm; 1,6 mm tykk; 2 m lang; uten spor; likner EN 60715; sølvfarget	www.wago.com/210-196
	Elementnr.: 210-197 Bæreskinne i stål; 35 x 15 mm; 1,5 mm tykk; 2 m lang; med spor; likner EN 60715; sølvfarget	www.wago.com/210-197
	Elementnr.: 210-198 Bæreskinne i kobber; 35 x 15 mm; 2,3 mm tykk; 2 m lang; uten spor; i henhold til EN 60715; kobberfarget	www.wago.com/210-198
	Elementnr.: 210-504 Bæreskinne i stål; 35 x 7,5 mm; 1 mm tykk; 2 m lang; med spor; galvanisert; i henhold til EN 60715	www.wago.com/210-504
	Elementnr.: 210-505 Bæreskinne i stål; 35 x 7,5 mm; 1 mm tykk; 2 m lang; uten spor; galvanisert; i henhold til EN 60715; sølvfarget	www.wago.com/210-505
	Elementnr.: 210-506 Bæreskinne i stål; 35 x 15 mm; 1,5 mm tykk; 2 m lang; uten spor; galvanisert; likner EN 60715; sølvfarget	www.wago.com/210-506
	Elementnr.: 210-508 Bæreskinne i stål; 35 x 15 mm; 1,5 mm tykk; 2 m lang; med spor; galvanisert; likner EN 60715; sølvfarget	www.wago.com/210-508
tools		
	Elementnr.: 210-658 Betjeningsverktøy; Kniv: 3,5 x 0,5 mm; med et delvis isolert skaft; vinklet; kort; flerfarget	www.wago.com/210-658
	Elementnr.: 210-720 Betjeningsverktøy; Kniv: 3,5 x 0,5 mm; med et delvis isolert skaft; flerfarget	www.wago.com/210-720
ferrule		
	Elementnr.: 216-241 Klemring; Strømpe for 0.5mm ² /20 AWG; isolert; elektro-tinnplettert; elektrolytisk kobber; gasstett-påpresset; i henhold til DIN 46228, del 4/09.90; hvit	www.wago.com/216-241
	Elementnr.: 216-242 Klemring; Strømpe for 0.75 mm ² / 18 AWG; isolert; elektro-tinnplettert; elektrolytisk kobber; gasstett-påpresset; i henhold til DIN 46228, del 4/09.90; grå	www.wago.com/216-242
	Elementnr.: 216-243 Klemring; Hylse for 1 mm ² / AWG 18; isolert; elektro-tinnplettert; elektrolytisk kobber; gasstett-påpresset; i henhold til DIN 46228, del 4/09.90; rød	www.wago.com/216-243
	Elementnr.: 216-244 Klemring; Hylse for 1,5 mm ² / AWG 16; isolert; elektro-tinnplettert; elektrolytisk kobber; gasstett-påpresset; i henhold til DIN 46228, del 4/09.90; sort	www.wago.com/216-244

Med forbehold om endringer. Vær også oppmerksom på ytterligere produktdokumentasjon!

WAGO Norge AS
Jerikoveien 20
1067 Oslo
Tel.: +47 22 30 94 60 | Fax: +47 22 30 94 51
Email: info.no@wago.com















Har du spørsmål om våre produkter?
Vi tar alltid gjerne imot di samtale på +49 (571) 887-44222.

	Elementnr.: 216-246 Klemring; Hylse for 2,5 mm ² / AWG 14; isolert; elektro-tinnplettert; elektrolytisk kobber; gasstett-påpresset; i henhold til DIN 46228, del 4/09.90; blå	www.wago.com/216-246
	Elementnr.: 216-262 Klemring; Strømpe for 0.75 mm ² / 18 AWG; isolert; elektro-tinnplettert; elektrolytisk kobber; gasstett-påpresset; i henhold til DIN 46228, del 4/09.90; grå	www.wago.com/216-262
	Elementnr.: 216-263 Klemring; Hylse for 1 mm ² / AWG 18; isolert; elektro-tinnplettert; elektrolytisk kobber; gasstett-påpresset; i henhold til DIN 46228, del 4/09.90; rød	www.wago.com/216-263
	Elementnr.: 216-264 Klemring; Hylse for 1,5 mm ² / AWG 16; isolert; elektro-tinnplettert; elektrolytisk kobber; gasstett-påpresset; i henhold til DIN 46228, del 4/09.90; sort	www.wago.com/216-264
	Elementnr.: 216-266 Klemring; Hylse for 2,5 mm ² / AWG 14; isolert; elektro-tinnplettert; elektrolytisk kobber; gasstett-påpresset; i henhold til DIN 46228, del 4/09.90; blå	www.wago.com/216-266
Push-In type wire jumper		
	Elementnr.: 2009-412 Pluggbar lask; isolert; 60 mm lang; sort	www.wago.com/2009-412
	Elementnr.: 2009-414 Pluggbar lask; 1,5 mm ² ; isolert; 110 mm lang; sort	www.wago.com/2009-414
	Elementnr.: 2009-414/000-005 Pluggbar lask; 1,5 mm ² ; isolert; 110 mm lang; sort	www.wago.com/2009-414/000-005
	Elementnr.: 2009-414/000-006 Pluggbar lask; isolert; 110 mm lang; sort	www.wago.com/2009-414/000-006
	Elementnr.: 2009-416 Pluggbar lask; 1,5 mm ² ; isolert; 250 mm lang; sort	www.wago.com/2009-416
Jumper		
	Elementnr.: 2002-400 Kontinuerlig lask; 2-veis; isolert; lysegrå	www.wago.com/2002-400
	Elementnr.: 2002-402 Lask; 2-veis; isolert; lysegrå	www.wago.com/2002-402
	Elementnr.: 2002-402/000-005 Lask; 2-veis; isolert; rød	www.wago.com/2002-402/000-005
	Elementnr.: 2002-402/000-006 Lask; 2-veis; isolert; blå	www.wago.com/2002-402/000-006
	Elementnr.: 2002-403 Lask; 3-veis; isolert; lysegrå	www.wago.com/2002-403

Med forbehold om endringer. Vær også oppmerksom på ytterligere produktdokumentasjon!

WAGO Norge AS
Jerikoveien 20
1067 Oslo
Tel.: +47 22 30 94 60 | Fax: +47 22 30 94 51
Email: info.no@wago.com















Har du spørsmål om våre produkter?
Vi tar alltid gjerne imot di samtale på +49 (571) 887-44222.

	Elementnr.: 2002-403/000-005 Lask; 3-veis; isolert; rød	www.wago.com/2002-403/000-005
	Elementnr.: 2002-403/000-006 Lask; 3-veis; isolert; blå	www.wago.com/2002-403/000-006
	Elementnr.: 2002-404 Lask; 4-veis; isolert; lysegrå	www.wago.com/2002-404
	Elementnr.: 2002-404/000-005 Lask; 4-veis; isolert; rød	www.wago.com/2002-404/000-005
	Elementnr.: 2002-404/000-006 Lask; 4-veis; isolert; blå	www.wago.com/2002-404/000-006
	Elementnr.: 2002-405 Lask; 5-veis; isolert; lysegrå	www.wago.com/2002-405
	Elementnr.: 2002-405/000-005 Lask; 5-veis; isolert; rød	www.wago.com/2002-405/000-005
	Elementnr.: 2002-405/000-006 Lask; 5-veis; isolert; blå	www.wago.com/2002-405/000-006
	Elementnr.: 2002-405/011-000 Stjernepunkt lask; 3-veis; isolert; lysegrå	www.wago.com/2002-405/011-000
	Elementnr.: 2002-406 Lask; 6-veis; isolert; lysegrå	www.wago.com/2002-406
	Elementnr.: 2002-406/000-005 Lask; 6-veis; isolert; rød	www.wago.com/2002-406/000-005
	Elementnr.: 2002-406/000-006 Lask; 6-veis; isolert; blå	www.wago.com/2002-406/000-006
	Elementnr.: 2002-406/020-000 Delta-lask; isolert; lysegrå	www.wago.com/2002-406/020-000
	Elementnr.: 2002-407 Lask; 7-veis; isolert; lysegrå	www.wago.com/2002-407



Med forbehold om endringer. Vær også oppmerksom på ytterligere produktdokumentasjon!

WAGO Norge AS
Jerikoveien 20
1067 Oslo
Tel.: +47 22 30 94 60 | Fax: +47 22 30 94 51
Email: info.no@wago.com

Har du spørsmål om våre produkter?
Vi tar alltid gjerne imot di samtale på +49 (571) 887-44222.

	Elementnr.: 2002-407/000-005 Lask; 7-veis; isolert; rød	www.wago.com/2002-407/000-005
	Elementnr.: 2002-407/000-006 Lask; 7-veis; isolert; blå	www.wago.com/2002-407/000-006
	Elementnr.: 2002-408 Lask; 8-veis; isolert; lysegrå	www.wago.com/2002-408
	Elementnr.: 2002-408/000-005 Lask; 8-veis; isolert; rød	www.wago.com/2002-408/000-005
	Elementnr.: 2002-408/000-006 Lask; 8-veis; isolert; blå	www.wago.com/2002-408/000-006
	Elementnr.: 2002-409 Lask; 9-veis; isolert; lysegrå	www.wago.com/2002-409
	Elementnr.: 2002-409/000-005 Lask; 9-veis; isolert; rød	www.wago.com/2002-409/000-005
	Elementnr.: 2002-409/000-006 Lask; 9-veis; isolert; blå	www.wago.com/2002-409/000-006
	Elementnr.: 2002-410 Lask; 10-veis; isolert; lysegrå	www.wago.com/2002-410
	Elementnr.: 2002-410/000-005 Lask; 10-veis; isolert; rød	www.wago.com/2002-410/000-005
	Elementnr.: 2002-410/000-006 Lask; 10-veis; isolert; blå	www.wago.com/2002-410/000-006
	Elementnr.: 2002-423 Kontinuerlig lask; fra 1 til 3; isolert; lysegrå	www.wago.com/2002-423
	Elementnr.: 2002-423/000-005 Kontinuerlig lask; fra 1 til 3; isolert; rød	www.wago.com/2002-423/000-005
	Elementnr.: 2002-423/000-006 Kontinuerlig lask; fra 1 til 3; isolert; blå	www.wago.com/2002-423/000-006









Med forbehold om endringer. Vær også oppmerksom på ytterligere produktdokumentasjon!

	Elementnr.: 2002-433 Lask; fra 1 til 3; isolert; lysegrå	www.wago.com/2002-433
	Elementnr.: 2002-434 Lask; fra 1 til 4; isolert; lysegrå	www.wago.com/2002-434
	Elementnr.: 2002-435 Lask; fra 1 til 5; isolert; lysegrå	www.wago.com/2002-435
	Elementnr.: 2002-436 Lask; fra 1 til 6; isolert; lysegrå	www.wago.com/2002-436
	Elementnr.: 2002-437 Lask; fra 1 til 7; isolert; lysegrå	www.wago.com/2002-437
	Elementnr.: 2002-438 Lask; fra 1 til 8; isolert; lysegrå	www.wago.com/2002-438
	Elementnr.: 2002-439 Lask; fra 1 til 9; isolert; lysegrå	www.wago.com/2002-439
	Elementnr.: 2002-440 Lask; fra 1 til 10; isolert; lysegrå	www.wago.com/2002-440
	Elementnr.: 2002-472 Forskjøvet lask; 2-veis; isolert; lysegrå	www.wago.com/2002-472
	Elementnr.: 2002-473 Forskjøvet lask; 3-veis; isolert; lysegrå	www.wago.com/2002-473
	Elementnr.: 2002-473/011-000 Forskjøvet lask; 2-veis; fra 1 til 3; isolert; lysegrå	www.wago.com/2002-473/011-000
	Elementnr.: 2002-474 Forskjøvet lask; 4-veis; isolert; lysegrå	www.wago.com/2002-474
	Elementnr.: 2002-475 Forskjøvet lask; 5-veis; isolert; lysegrå	www.wago.com/2002-475
	Elementnr.: 2002-475/011-000 Forskjøvet lask; 3-veis; isolert; lysegrå	www.wago.com/2002-475/011-000
	Elementnr.: 2002-476 Forskjøvet lask; 6-veis; isolert; lysegrå	www.wago.com/2002-476
	Elementnr.: 2002-477 Forskjøvet lask; 7-veis; isolert; lysegrå	www.wago.com/2002-477
	Elementnr.: 2002-477/011-000 Forskjøvet lask; isolert; lysegrå	www.wago.com/2002-477/011-000

Med forbehold om endringer. Vær også oppmerksom på ytterligere produktdokumentasjon!

WAGO Norge AS
Jerikoveien 20
1067 Oslo
Tel.: +47 22 30 94 60 | Fax: +47 22 30 94 51
Email: info.no@wago.com

Har du spørsmål om våre produkter?
Vi tar alltid gjerne imot di samtale på +49 (571) 887-44222.

	Elementnr.: 2002-478 Forskjøvet lask; 8-veis; isolert; lysegrå	www.wago.com/2002-478
	Elementnr.: 2002-479 Forskjøvet lask; 9-veis; isolert; lysegrå	www.wago.com/2002-479
	Elementnr.: 2002-479/011-000 Forskjøvet lask; isolert; lysegrå	www.wago.com/2002-479/011-000
	Elementnr.: 2002-480 Forskjøvet lask; 10-veis; isolert; lysegrå	www.wago.com/2002-480
	Elementnr.: 2002-481 Forskjøvet lask; 11-veis; isolert; lysegrå	www.wago.com/2002-481
	Elementnr.: 2002-481/011-000 Forskjøvet lask; isolert; lysegrå	www.wago.com/2002-481/011-000
	Elementnr.: 2002-482 Forskjøvet lask; 12-veis; isolert; lysegrå	www.wago.com/2002-482
	Elementnr.: 2002-492 Vertikal lask; isolert; lysegrå	www.wago.com/2002-492
	Elementnr.: 2002-492/000-012 Vertikal lask; isolert; oransje	www.wago.com/2002-492/000-012
	Elementnr.: 210-103 Ledningskjede; isolert; sort	www.wago.com/210-103
	Elementnr.: 210-123 Ledningskjede; isolert; blå	www.wago.com/210-123

Nedlastinger Documentation

Bid Text

2002-2701 X81 - Datei	18.apr.2019	xml 4,2 kB	Last ned
2002-2701 docx - Datei	18.apr.2019	docx 15,3 kB	Last ned
Additional Information Technical explanations	03.apr.2019	pdf 2,2 MB	Last ned

Med forbehold om endringer. Vær også oppmerksom på ytterligere produktdokumentasjon!

WAGO Norge AS
Jerikoveien 20
1067 Oslo
Tel.: +47 22 30 94 60 | Fax: +47 22 30 94 51
Email: info.no@wago.com

Har du spørsmål om våre produkter?
Vi tar alltid gjerne imot di samtale på +49 (571) 887-44222.

CAD/CAE-Data

CAD data

2D/3D Models 2002-2701	URL	Last ned
------------------------	---------------------	----------

CAE data

EPLAN Data Portal 2002-2701	URL	Last ned
-----------------------------	---------------------	----------

ZUKEN Portal 2002-2701	URL	Last ned
------------------------	---------------------	----------

Installasjonsmerknader

Conductor termination

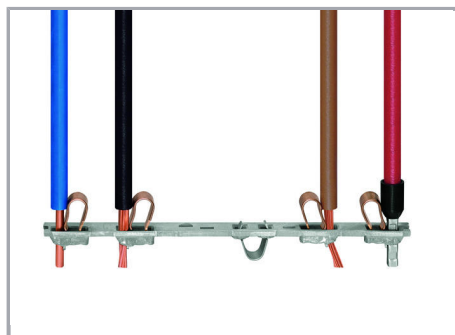

All conductor types at a glance

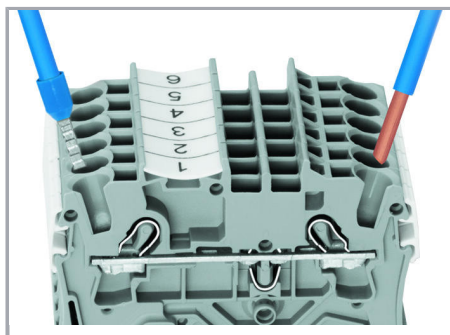

Terminating solid and ferruled conductors via push-in connection.

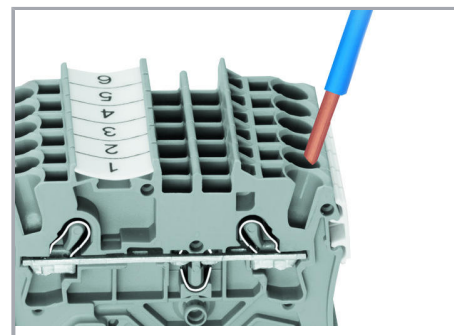

Inserting conductors via push-in termination.

Solid conductors with cross-sections from either one size above, or up to two sizes below, the rated cross-section can be simply pushed in – no tools needed.

Med forbehold om endringer. Vær også oppmerksom på ytterligere produktdokumentasjon!

WAGO Norge AS
Jerikoveien 20
1067 Oslo
Tel.: +47 22 30 94 60 | Fax: +47 22 30 94 51
Email: info.no@wago.com

Har du spørsmål om våre produkter?
Vi tar alltid gjerne imot di samtale på +49 (571) 887-44222.

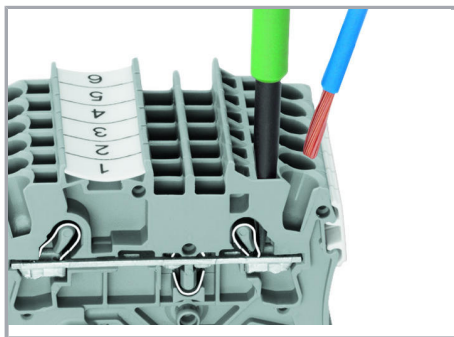

Inserting a conductor via operating tool.

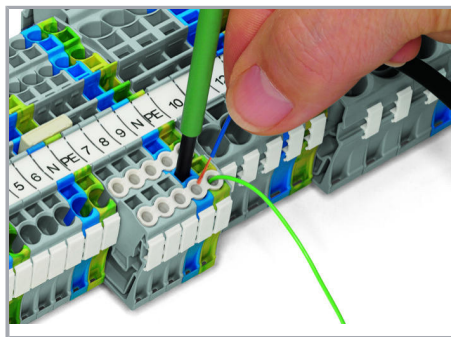

Conductor termination – Insulation stop.

Connecting fine-stranded conductors without ferrules, or small cross-sectional conductors that cannot be pushed in, is performed similarly to the original CAGE CLAMP® – just use an operating tool.

The smart feature:

To open the clamp, the operating tool is inserted vertically. The conductor entry is less than 15 degrees for easier wiring.

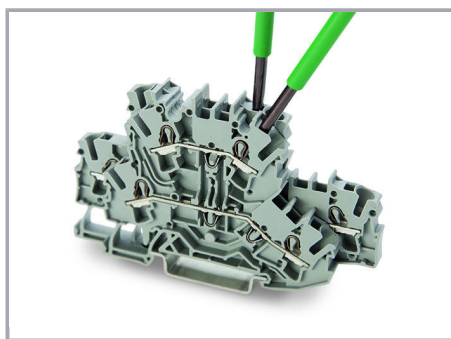

Med forbehold om endringer. Vær også oppmerksom på ytterligere produktdokumentasjon!