

NB 443
2010.05.20
Rev. 1.2





Bruksanvisning DCL Vegguttak

User Guide DCL Wall Outlet

(Device for Connection of Luminaries)

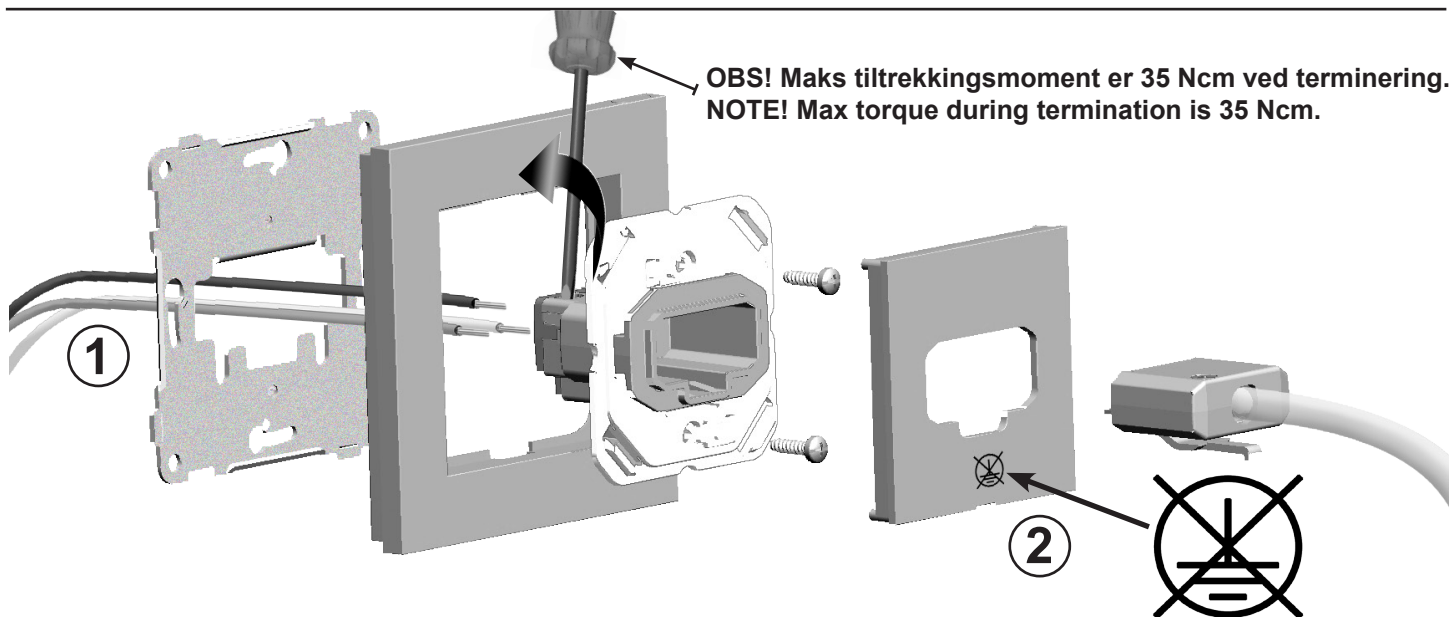
ELKO Plus, ELKO RS16



Om jord ikke er tilsluttet skal dette merkes behørig. Bruk medfølgende symbolklistremærke:  og plassér den slik som vist på fig.2. OBS! Pass på at ledningene er trukket gjennom begge rammer som vist på fig.1.

The absence of connected earth must be displayed properly. Use the supplied symbol sticker:  and place it as shown on fig.2. NOTE! Remember to draw the wiring through both frames as shown on fig.1.

Demontering av lokket /
To release cover:

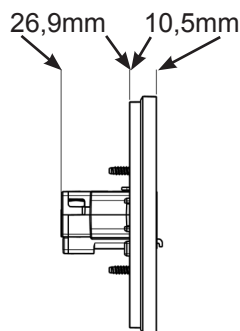
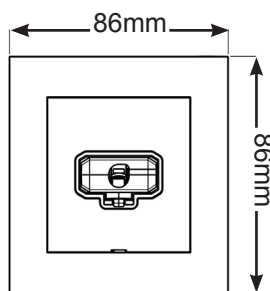
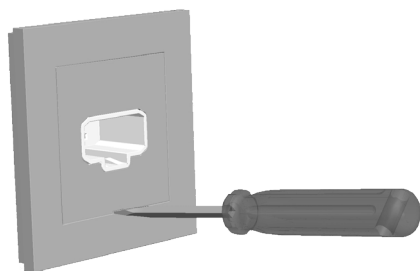

Tekniske data / Technical Data:

Maks belastning/
Max output: 6A
Spenning/Voltage: 250V

Terminering av plugg / Connecting the Plug:

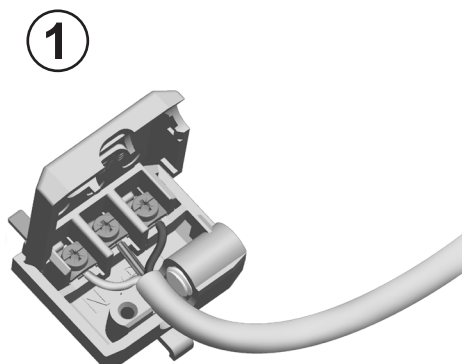

① Ledningene termineres.
NB! Jording i midten.
/Connect electric wiring.
NOTE! Earth in the middle.

② Lukk igjen lokket og skru fast.
/Close the cover and screw tight.

③ Trekk til strekkavlaster med riktig moment.
/Tighten chord-anchor with correct torque pressure.

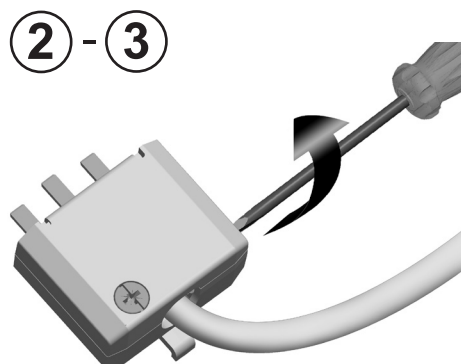





Bruksanvisning DCL Takuttak

User Guide DCL Ceiling Outlet

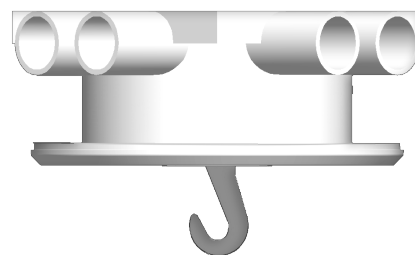
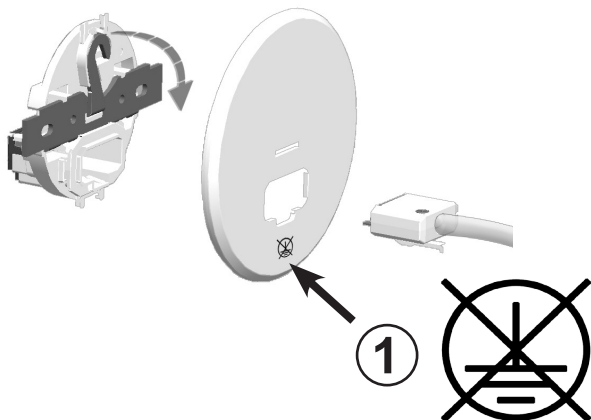
(Device for Connection of Luminaries)



Om jord ikke er tilsluttet skal dette merkes behørig. Bruk medfølgende symbolklistermerke:  og plassér den slik som vist på fig.1.

The absence of connected earth must be displayed properly. Use the supplied symbol sticker:  and place it as shown on fig.1.

Takboks som er 40mm og over kan benyttes uten å ta noen ekstra hensyn ved montering.

Flush mounting boxes which are 40mm and above can be used without any additional consideration during the assembly.

Ved bruk av takboks under 40mm dybde må det benyttes avstandsring (art. nr. 4975). Dette må bestilles separat.

When using flush mounting boxes below 40mm in depth, a spacer ring (Art. No. 4975) must be used. This must be ordered separately.

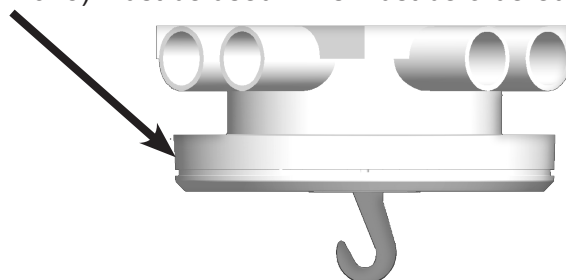
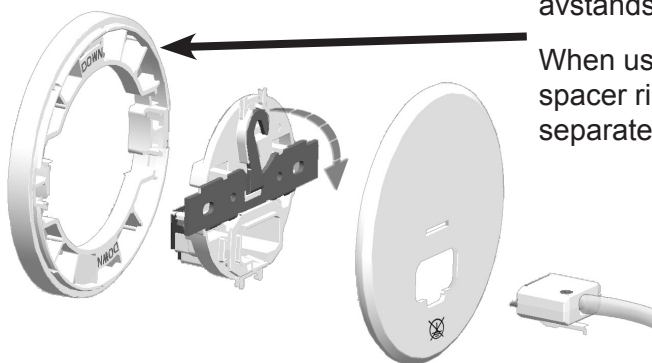

Demontering av lokket / To release cover:

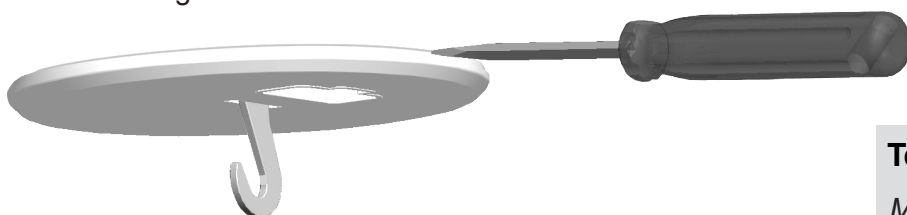

Tekniske data / Technical Data:

Maks belastning/Max output: 6A
Spenning/Voltage: 250V