

DDA 800

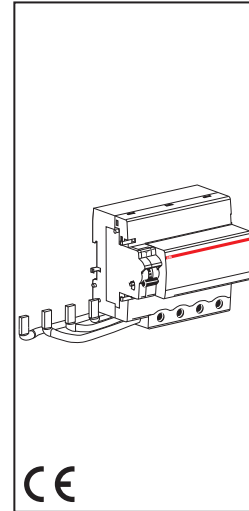

2CSB427001D0015

DDA800 AC	S800 C
DDA800 A	S800 B
DDA800 A S	S800 S
DDA800 A AP-R	S800 N

ABB S.p.A.
V.le dell'Industria 18
20010 Vittuone (MI), Italy



www.abb.com/lowvoltage

S 802 ... + DDA 802 ...

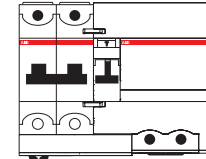

S 803 ... + DDA 803 ...

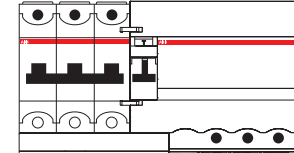

S 804 ... + DDA 804 ...

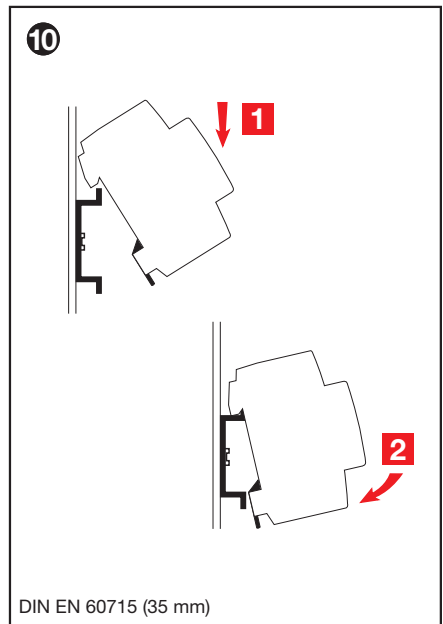
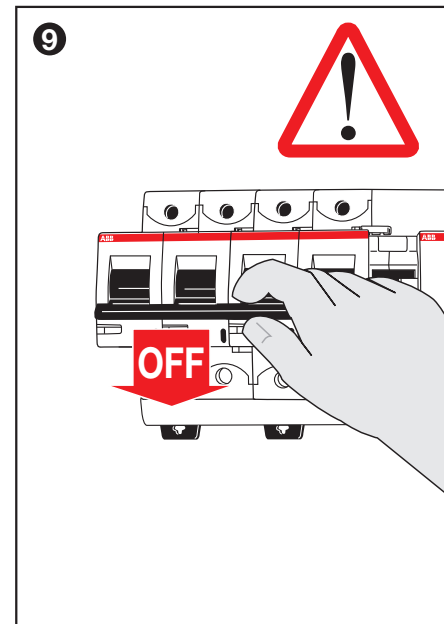
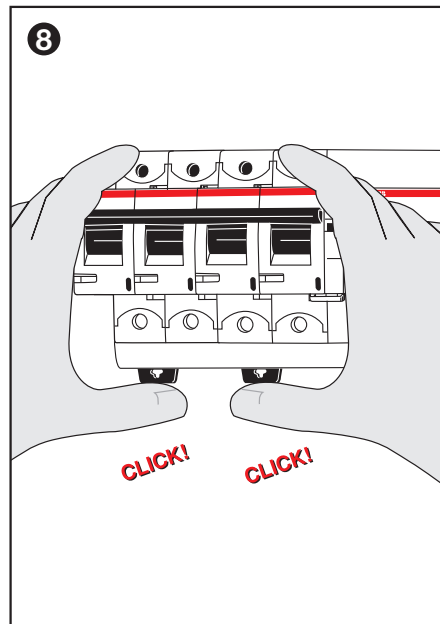
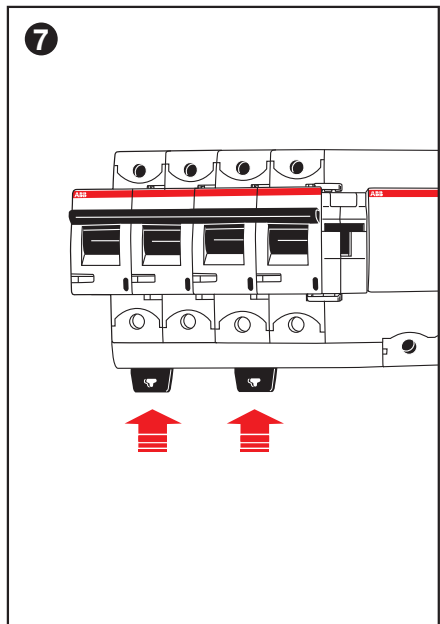
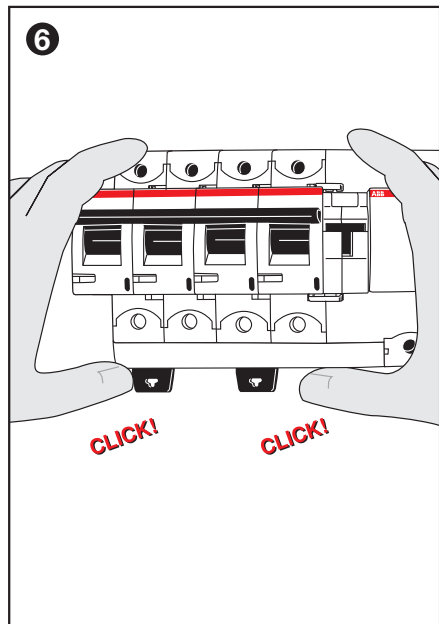
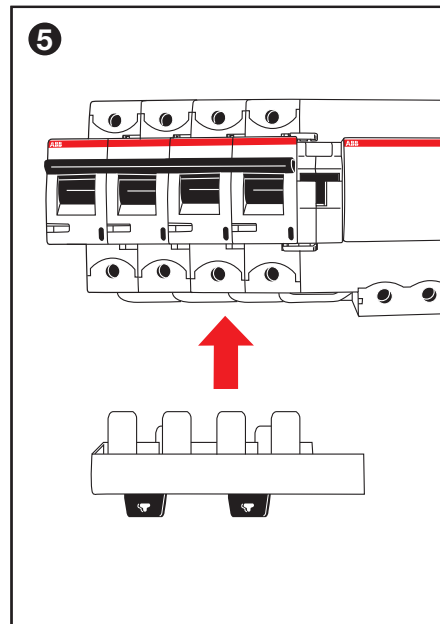
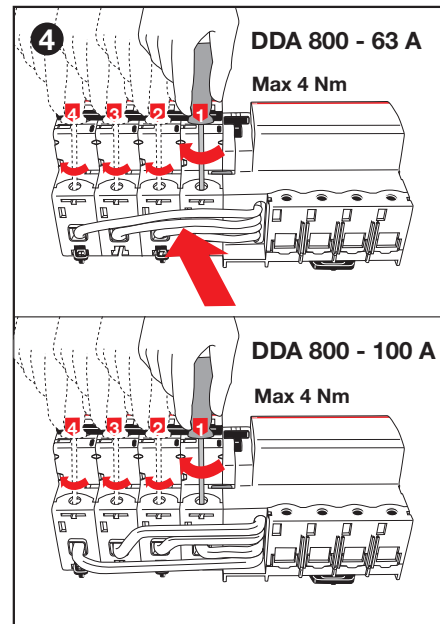
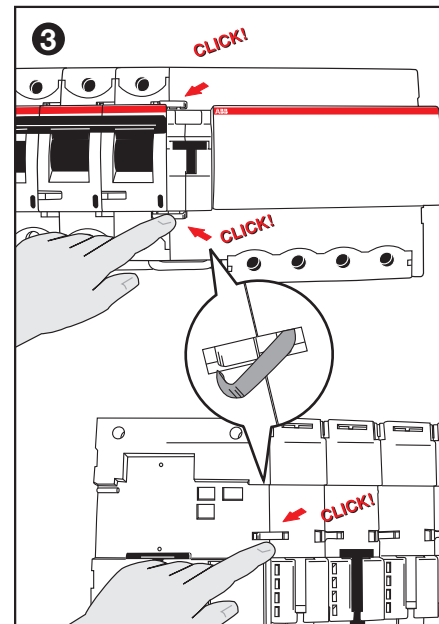
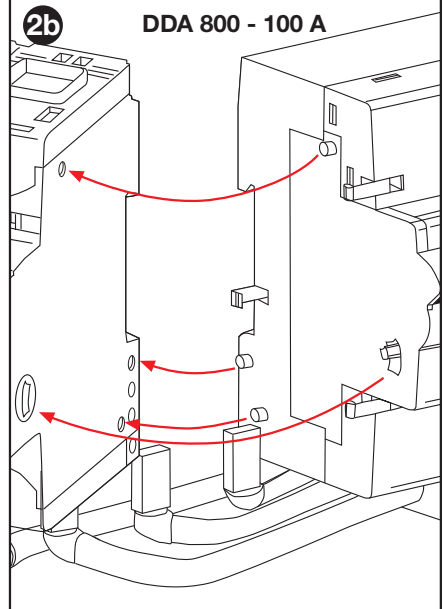
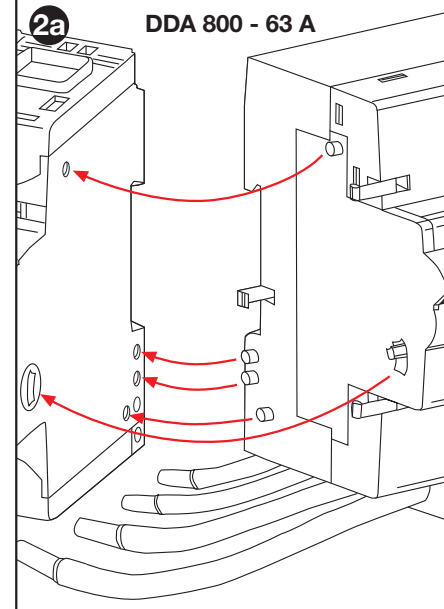
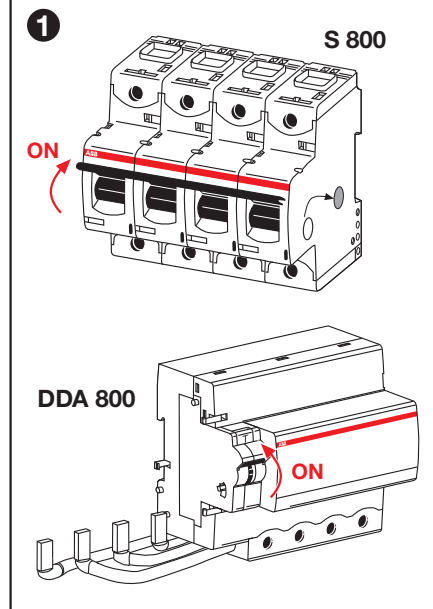
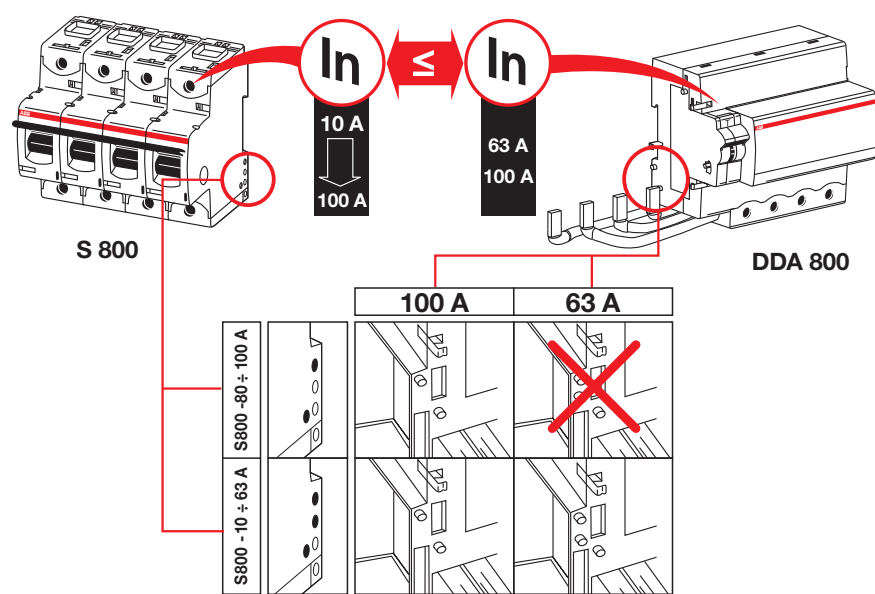
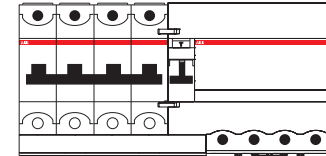

DIN EN 60715 (35 mm)



Warning! Installation by person with electrotechnical expertise only.
Warnung! Installation nur durch elektrotechnische Fachkraft.
Avvertenza! Fare installare solo da un elettricista qualificato.
Avertissement! Installation uniquement par des personnes qualifiées en électrotechnique.
¡Advertencia! La instalación deberá ser realizada únicamente por electricistas especializados.

3,5 Nm

