

Electrical installation solutions for buildings

ABB i-bus® KNX

ABB MyBuildings portal	2
Service & Support Tools	5
Overview	6
Power Supply	8
System Infrastructure and Interfacing	13
Connection and Wiring	18
Multifunction Room Automation	20
Inputs	29
Outputs	35
Shading Control	47
Lighting Control	54
Movement and Presence Detection	71
Heating, Ventilation and Air Conditioning	85
Automation, Logic and Time Control	106
Visualisation, Display and Signalling	113
Energy Management	123
Safety and Monitoring	129
Security	130
Guest Room Management	146
User Operation – Design Ranges	156
Unique diversity of the range	156
Functional Overview	158
PEONIA®	176
ABB tacteo®	192
Busch-priOn®	204
ABB Tenton®	213
Standard Control Elements	220
Multifunction Control Elements	222
Movement Detectors	226
Room Thermostats	228
Frames	229
Busch-triton®	236
Push Button Coupling Unit	238
Millenium	256
Zenit	264
Mylos	282
Chiara	288

You may also visit our KNX website:



www.abb.com/knx

CONNECTIVITY

Shaping the future of the digital world today requires fully automated solutions that can be networked with all other intelligent devices.

14

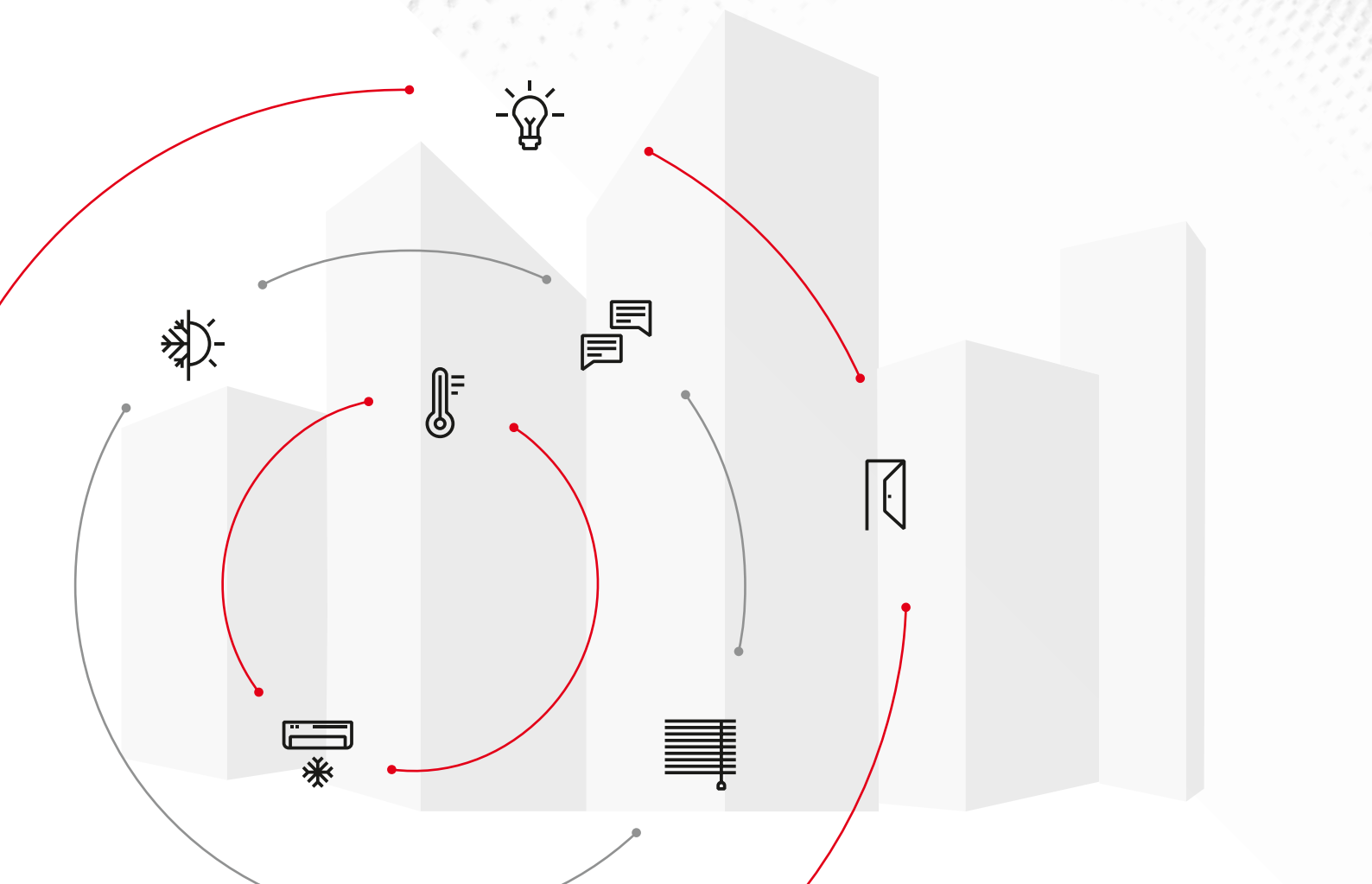

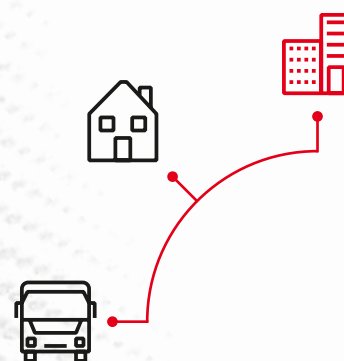

Powerful digital solutions in a single portfolio

MyBuildings portal powered by ABB Ability™

Controlling and planning smart buildings is now easier than ever: ABB bundles its digital services for Smarter Home and Building in the MyBuildings portal (formerly my.abb-livingspace.com) under the ABB Ability umbrella. The online portal gives you access to many of ABB's tools and services that you can use for your individual needs. You have the option to configure KNX systems, fire alarm technology, door entry system or ABB tacteo® KNX as well as to extend system functionality with remote access or Amazon Alexa voice control. You can also connect your smart system to a mobile device.

You may also visit our MyBuildings portal under mybuildings.abb.com:



Plan, configure and modify as desired with the MyBuildings portal powered by ABB Ability™

CONNECTIVITY

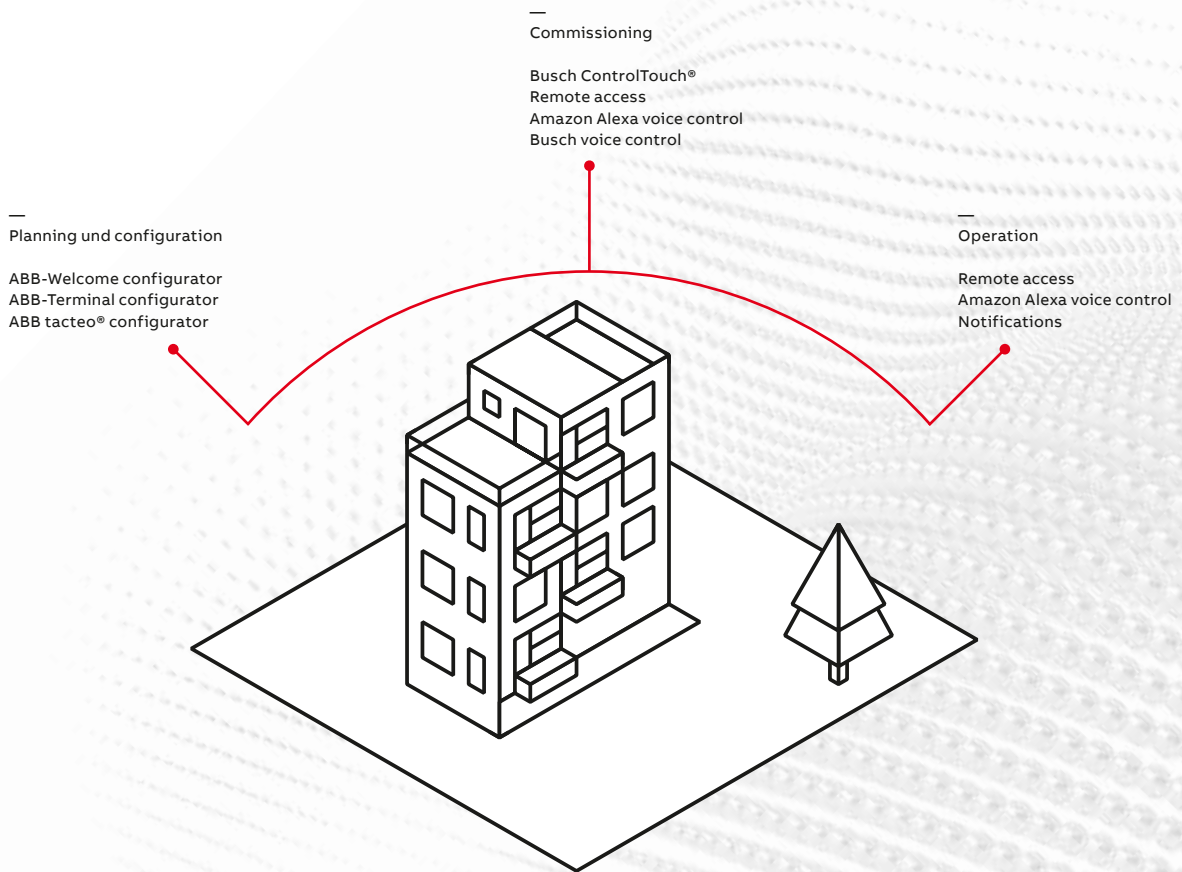

A central contact point for Smarter Building services.



Global availability of ABB services.



24/7 monitoring for best worldwide availability.



Regular cyber security: audits and tests by independent third parties.

ABB i-bus® KNX – Service & Support Tools

For a fast and intuitive self-support in your daily work

ABB provides a wide range of tools to enable an uncomplicated and time-saving support for many of your concerns. Below you can find some tools which helps you during configuration and commissioning of your i-bus® KNX installation.



ABB i-bus® Tool

A professional service tool which supports system integrators during commissioning and service of KNX installations. For more information and to download the tool have a look on the linked website.



Visit our website

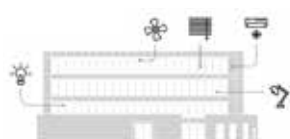

ABB Update Copy Convert

The ETS app Update Copy Convert provides a series of useful functions for ETS applications and device configuration (parameters and group addresses) in an ETS project.

The functions are:

- Update: Changes the application program to a later or earlier version while retaining current configurations.
- Convert: Transfers/adopts a configuration from an identical or compatible source device.
- Channel Copy: Copies a channel configuration to other channels on a multichannel device.
- Channel Exchange: Exchanges configurations between two channels on a multichannel device.
- Import/Export: Saves and reads device configurations as external files.



Download the app



Firmware Update 2.0

With this ETS app you are able to updating the firmware of your device directly via the KNX bus. The app can be used with the ETS5 or higher.



Download the app

ABB i-bus® KNX

Overview

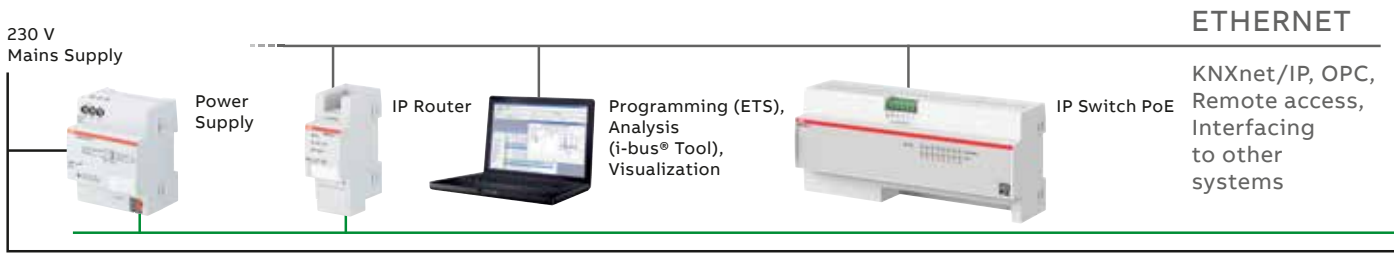

Energy consumption measurement

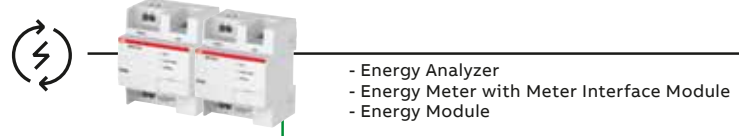

Switch energy with and without current detection



Switch energy with energy measurement

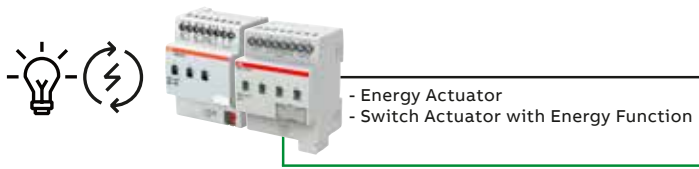

Switch, dim and control light

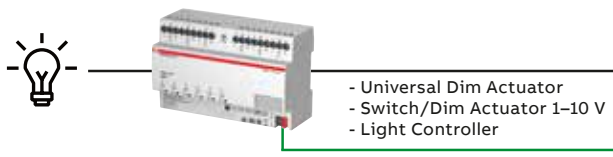

Digital lighting control using DALI



Control of shutters, blinds and ventilation flaps with and without automatic travel time detection



Heating/cooling via valve control

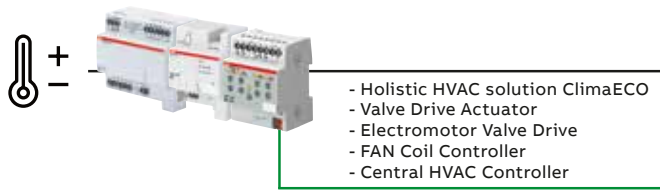

Ventilation/climatization

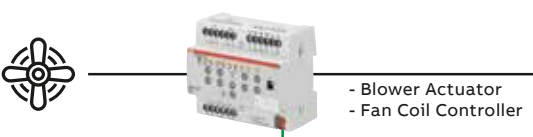

Room solutions with integrated sensor and actuator functions

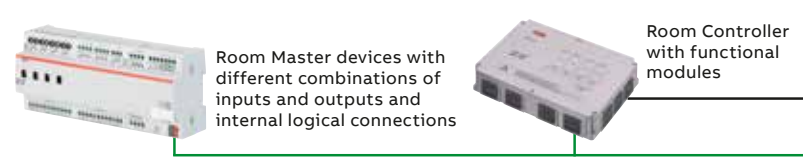

14

KNX-Main Line/TP

Line 1 2 3 4 ... 13 14 15



- 64 devices/line
- 15 lines/area with superordinated main line
- max. 15 areas with superordinated area line

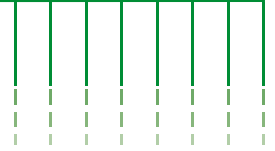

- Binary Input



Detect and evaluate switching commands

- Analogue Input



Capture, evaluate and monitor physical values

- Weather Station and Weather Sensor



Evaluate and monitor meteorological data (wind, temperature, rain, etc.)



Remote control via internet

Display operating conditions and control functions

- Presence Detector
- Movement Sensor
- Light Sensor



Lighting Control

Detect presence and movement

Measure brightness levels

- Logic Module
- Application Unit Logic
- Application Unit Time
- Time Switch

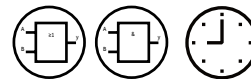

Perform logical operations and trigger timer-controlled functions

- Room Thermostat
- Air Quality Sensor



Capture, evaluate, monitor and control room conditions, temperature, air quality, etc.

- Security Terminal
- Security Module
- KNX Security Panel
- Fault Monitoring Unit
- Monitoring Unit
- Data Logging Unit



12 V

Security System



Monitor operating conditions, signal technical faults, recognize hazards and trigger alarms

- Room outside sensor with card reader
- Transponder Card
- Configuration Software



Access Control system for hotel rooms

ABB i-bus® KNX

Power Supply

	Standard			Diagnostic		Uninterruptible SU/S 30.640.2
	SV/S 30.160.1.1	SV/S 30.320.1.1	SV/S 30.640.3.1	SV/S 30.320.2.1	SV/S 30.640.5.1	
General						
Supply voltage	100 – 240 V AC (85...265 V AC)	100 – 240 V AC (85...265 V AC)	100 – 240 V AC (85...265 V AC)	100 – 240 V AC (85...265 V AC)	100 – 240 V AC (85...265 V AC)	100 – 240 V AC (210...240 V AC)
Type of installation	DIN-Rail	DIN-Rail	DIN-Rail	DIN-Rail	DIN-Rail	DIN-Rail
Module width (18 mm)	4	4	4	4	4	8
Rated current I _n	160 mA	320 mA	640 mA	320 mA	640 mA	640 mA
Rated voltage U _n	30 V DC	30 V DC	30 V DC	30 V DC	30 V DC	30 V DC
Back-up						
Mains failure back-up time without battery	200 ms	200 ms	200 ms	200 ms	200 ms	200 ms
Mains failure back-up time with new, fully charged battery up to	–	–	–	–	–	AM/S: 10 min SAK7: 2.5 h 2 x SAK7: 5 h 2 x SAK12: 11 h 2 x SAK7: 16 h
Choke						
Integrated choke	■	■	■	■	■	■
Extra Voltage output without choke (30 V DC)	–	–	■	–	■	–
Operation and indication						
Short-circuit and overload indication	■	■	■	■	■	■
Output voltage indication	■	■	■	■	■	■
Overload indication	■	■	■	■	■	■
Bus current indication	–	–	–	■	■	–
Telegram traffic indication	–	–	–	■	■	–
Communication error indication	–	–	–	■	■	–
Bus reset button and indication	–	–	–	■	■	–
Mains voltage indication	■	■	■	■	■	■
Battery voltage indication	–	–	–	–	–	■
Reporting						
Floating contact for fault reporting	–	–	–	–	–	■
Commissioning and diagnostic functions						
Control and diagnosis via ABB i-bus® Tool	–	–	–	■	■	–

■ = Function is supported

– = Function is not supported



SV/S 30.160.1.1

Power Supply, 160 mA, MDRC

KNX power supplies generate and monitor the KNX system voltage (SELV). The bus line is decoupled from the power supply by an integrated choke.

The voltage output is short-circuit and overload protected.

The two-color LED indicates device output status. With two-coloured status indicator and wide range input from 85...265 V AC, 50/60 Hz.

Description	Mod. width	Order details		Price	Weight	Pack
		Type code	Order code	1 piece	1 piece	unit
				€	kg	pc.
	4	SV/S 30.160.1.1	2CDG110144R0011		0.30	1



SV/S 30.320.1.1

Power Supply, 320 mA, MDRC

KNX power supplies generate and monitor the KNX system voltage (SELV). The bus line is decoupled from the power supply by an integrated choke.

The voltage output is short-circuit and overload protected.

The two-color LED indicates device output status.

With two-coloured status indicator and wide range input from 85...265 V AC, 50/60 Hz.

Description	Mod. width	Order details		Price	Weight	Pack
		Type code	Order code	1 piece	1 piece	unit
				€	kg	pc.
	4	SV/S 30.320.1.1	2CDG110166R0011		0.30	1



SV/S 30.640.3.1

Power Supply, 640 mA, MDRC

KNX power supplies generate and monitor the KNX system voltage (SELV). The bus line is decoupled from the power supply by an integrated choke. The voltage output is short-circuit and overload protected.

The two-color LED indicates device output status.

Device type SV/S 30.640.3.1 has an additional 30 V DC short-circuit and overload protected voltage output that can be used to power an additional bus line (in combination with a separate choke).

With two-coloured status indicator and wide range input from 85...265 V AC, 50/60 Hz.

Description	Mod. width	Order details		Price	Weight	Pack
		Type code	Order code	1 piece	1 piece	unit
				€	kg	pc.
	4	SV/S 30.640.3.1	2CDG110167R0011		0.30	1

ABB i-bus® KNX Power Supply



SV/S 30.320.2.1

Power Supply with Diagnostics, 320 mA, MDRC

Compact Power Supply with integrated choke. Quick diagnostics by LED display and ETS communication objects. Analysis of the operating state and the bus line possible by means of ABB i-bus® Tool.

Description	Mod. width	Order details		Price	Weight	Pack
		Type code	Order code	1 piece	1 piece	unit
				€	kg	pc.
	4	SV/S 30.320.2.1	2CDG110145R0011		0.26	1



SV/S 30.640.5.1

Power Supply with Diagnostics, 640 mA, MDRC

Compact Power Supply with integrated choke. Quick diagnostics by LED display and ETS communication objects. Analysis of the operating state and the bus line possible by means of ABB i-bus® Tool. Additional voltage output to supply an additional line in conjunction with an additional choke.

Description	Mod. width	Order details		Price	Weight	Pack
		Type code	Order code	1 piece	1 piece	unit
				€	kg	pc.
	4	SV/S 30.640.5.1	2CDG110146R0011		0.26	1



SU/S 30.640.2

Uninterruptible KNX Power Supply, 640 mA, MDRC

NEW

Uninterruptible power supply 640 mA with integrated choke for supplying an ABB i-bus® KNX bus line, short-circuit- and overload-proof. LEDs to indicate the status of the bus current, mains voltage, and battery voltage. Wide range input from 85...265 V AC, 50/60 Hz. The accumulator module AM/S 12.1 or up to 2 rechargeable batteries can be charged in normal operation by the voltage supply. The bus voltage is provided utilising the batteries in the event of a mains failure.

Available March 2023

Description	Mod. width	Order details		Price	Weight	Pack
		Type code	Order code	1 piece	1 piece	unit
				€	kg	pc.
	8	SU/S 30.640.2	2CDG110275R0011		0.40	1



AM/S 12.1

Battery Module, 12 V DC, MDRC

With lead-gel battery for use in uninterruptible power supply SU/S 30.640.2 and for maintaining the bus voltage during a mains failure for 10 minutes (at full load). Connection is made via 4-core standard cable.

Description	Mod. width	Order details		Price	Weight	Pack
		Type code	Order code	1 piece	1 piece	unit
				€	kg	pc.
	8	AM/S 12.1	GHQ6310062R0111		0.81	1



KS/K 4.1



KS/K 2.1

Cable Sets

For connection of sealed lead gel batteries SAK7, SAK12 and SAK17 to the uninterruptible KNX power supply SU/S 30.640.2 or the uninterruptible power supply NTU/S 12.2000.1. If only one battery is connected, the basic cable set KS/K 4.1 with integrated temperature sensor is to be used. In case two batteries are connected in parallel, the basic cable set KS/K 4.1 is to be used for the first battery and the extension cable set KS/K 2.1 is to be used for the second battery. It is not permitted to connect more than two batteries in parallel.

Description	Mod. width	Order details		Price	Weight	Pack unit
		Type code	Order code	1 piece	1 piece	
				€	kg	pc.
Basic	-	KS/K 4.1	GHQ6301910R0001		0.18	1
Extension	-	KS/K 2.1	GHQ6301910R0011		0.12	1



SAK17, SAK12, SAK7

Sealed Lead Acid Batteries, 12 V DC

For maintaining the bus voltage during a mains failure. For connection to the uninterruptible power supply SU/S 30.640.2 or the uninterruptible power supply NTU/S 12.2000.1. A maximum of two batteries of the same type can be connected in parallel. For connection, the cable sets KS/K 4.1 and KS/K 2.1 are to be used.

Description	Mod. width	Order details		Price	Weight	Pack unit
		Type code	Order code	1 piece	1 piece	
				€	kg	pc.
7,2 Ah	-	SAK7	GHV9240001V0011		2.98	1
12 Ah	-	SAK12	GHV9240001V0012		4.66	1
18 Ah	-	SAK17	GHV9240001V0013		7.15	1



DR/S 4.1

Choke, MDRC

The device can be used together with a SV/S 30.640.5.1 or SV/S 30.640.3.1 to supply a second line. The device has a reset switch for isolating the bus voltage and resetting the bus devices connected to this line. Connection to ABB i-bus® via Bus Connection Terminal.

Description	Mod. width	Order details		Price	Weight	Pack unit
		Type code	Order code	1 piece	1 piece	
				€	kg	pc.
	2	DR/S 4.1	2CDG110029R0011		0.16	1



NTI/Z 28.30.1

Commissioning Power Supply, 28 V DC, 30 mA

For temporary power supply of KNX devices during commissioning. The Euroconnector and plug-in terminal provide faster connection and supply of devices with manual operation (e.g. FCC/S or SA/S).

Description	Mod. width	Order details		Price	Weight	Pack unit
		Type code	Order code	1 piece	1 piece	
				€	kg	pc.
	-	NTI/Z 28.30.1	2CDG110096R0011		0.14	1

ABB i-bus® KNX Power Supply



CP-D 24/2.5

Power Supply Units, MDRC

The supply units that can be used universally as auxiliary power supply in KNX installations or other SELV applications. The devices supply a regulated output voltage of 12 V DC or 24 V DC with a maximum output current of 0.42 A up to 4.2 A. The units are protected against overload, the output being able to sustain a continuous short circuit. LED indication of the status of the supply and output voltage. With a width between one to five modules only, the CP-D range power supplies are ideally suited for the installation in distribution panels. Optimized for world-wide applications: The CP-D power supplies can be supplied with a rated voltage of 100 – 240 V AC.

Description	Mod. width	Order details		Price	Weight	Pack unit
		Type code	Order code	1 piece	1 piece	
				€	kg	pc.
12 V DC, 0.83 A	1	CP-D 12/0.83	1SVR427041R1000		0.07	1
12 V DC, 2.1 A	3	CP-D 12/2.1	1SVR427043R1200		0.20	1
24 V DC, 0.42 A	1	CP-D 24/0.42	1SVR427041R0000		0.07	1
24 V DC, 1.3 A	3	CP-D 24/1.3	1SVR427043R0100		0.20	1
24 V DC, 2.5 A	4	CP-D 24/2.5	2CDG120037R0011		0.25	1
24 V DC, 4.2 A	5	CP-D 24/4.2	1SVR427045R0400		0.39	1
Redundancy Unit for decoupling of two CP-D power supply units	2	CP-D RU	1SVR427049R0000		0.08	1



NTU/S 12.2000.1

Uninterruptible Power Supply, 12 V DC, 2 A, MDRC

Delivers sufficient power for all types of demanding applications with a buffered output voltage of 12 V DC (SELV) and a maximum output current of 2 A. Operating malfunctions of the power supply are signalled via a changeover contact and can be sent for evaluation purposes. Up to two 12 V DC sealed lead-acid batteries (gel cell) can be connected in parallel with the power supply, in conjunction with the KS/K 4.1 and KS/K 2.1 cable sets, or the AM/S 12.1 battery module.

Description	Mod. width	Order details		Price	Weight	Pack unit
		Type code	Order code	1 piece	1 piece	
				€	kg	pc.
	8	NTU/S 12.2000.1	2CDG110070R0011		0.43	1

ABB IP switches for DIN-Rail installation

Simplifying IP connectivity inside your cabinet

The IP infrastructure plays an important role for the reliability and availability of all building functions.

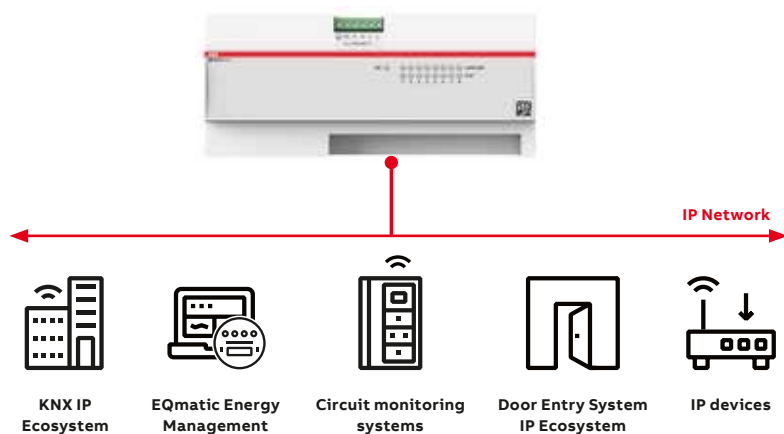
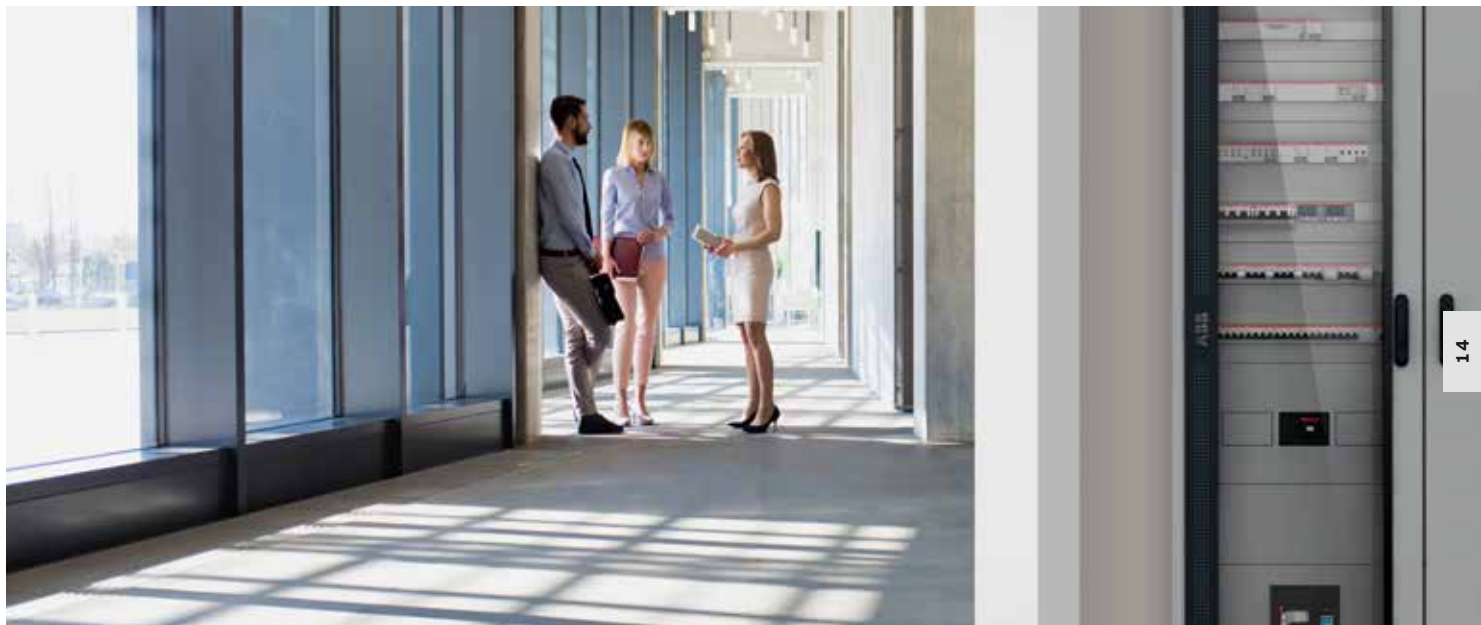

The ABB IP switches are two industrial-grade, 8 Ports, Fast Ethernet, unmanaged switches (with and without PoE) designed for installation in electrical distribution boards and easy mounting on DIN-Rails.

The new ABB IP switches are suitable for all applications, segments and markets in which distribution boards with DIN-Rail devices requiring IP connectivity are used.

- **Special Design**
- **Easy Installation**
- **Compact Technology**

ABB i-bus® KNX

System Infrastructure and Interfacing

	IP Router IPR/S 3.1.1		IP Router Secure IPR/S 3.5.1	IP Interface IPS/S 3.1.1		IP Interface Secure IPS/S 3.5.1	Line Coupler LK/S 4.2	
General								
Auxiliary voltage	10...30 V DC or PoE IEEE 802.3af class 1		10...30 V DC or PoE IEEE 802.3af class 1	10...30 V DC or PoE IEEE 802.3af class 1		10...30 V DC or PoE IEEE 802.3af class 1	-	
Type of installation	DIN-Rail		DIN-Rail	DIN-Rail		DIN-Rail	DIN-Rail	
Application	IP Router/ 1.1	IP Router/ 2.0	IP Router Secure/ 1.0	IP Interface/ 1.1	IP Interface/ 2.0	IP Interface Secure/ 1.0	Couple/1.1 or Repeat/1.1	Couple Repeat/2.1
ETS	ETS 3	ETS 4/5	ETS 5	ETS 3	ETS 4/5	ETS 5	ETS 3	ETS 4/5
Software functions								
KNX Secure	-	-	■	-	-	■	-	-
Number of tunneling servers	1	5	5	1	5	5	-	-
Number of unicast connections	10	10	10	-	-	-	-	-
Monitoring of bus voltage failure	■	■	■	-	-	-	-	-
Filter Group telegrams main group 0...13	■	■	■	-	-	-	■	■
Filter Group telegrams main group 14...31	-	(ETS 4.1.7 or higher)	■	-	-	-	-	■
Function Repeater	-	-	-	-	-	-	■	■
Commissioning and diagnostic functions								
Control and diagnosis via ABB i-bus® Tool	■	■	■	■	■	■	■	■
Firmware update (ABB i-bus® Tool or ETS App)	■	■	■	■	■	■	-	-
Unicast parameterization (ABB i-bus® Tool)	■	■	■	-	-	-	-	-

- = Function is supported
 - = Function is not supported



LK/S 4.2

Line Coupler, MDRC

The line coupler is used in larger installations to connect KNX lines or areas. The lines or areas are galvanically isolated from one another. Telegrams can be filtered to simultaneously reduce the telegram traffic between lines or areas. With ETS 4 (V4.1.2 and higher) the complete group address range of the main groups 0...31 can be filtered. Within a line, the LK/S 4.2 can also be used as a line amplifier (repeater). The device supports long frames (from > ETS5) and KNX Data Secure communication. KNX Data Secure telegrams are processed, filtered, forwarded, or blocked depending on settings.

Description	Mod. width	Order details		Price	Weight	Pack
		Type code	Order code	1 piece	1 piece	unit
				€	kg	pc.
	2	LK/S 4.2	2CDG110171R0011		0.1	1



IPR/S 3.5.1

IP Router Secure, MDRC

Connects the KNX bus with the Ethernet network and encrypts communication on the IP backbone. The device uses the KNXnet/IP Secure protocol for communication (Routing and Tunneling). It can be used as a fast line and area coupler. The full filter table for main groups 0-31 is supported. KNX devices can be programmed via the LAN using ETS. For this and further clients 5 Secure Tunneling Servers are available. The IP address can be fixed or can be received from a DHCP server. Power supply via 12...30 V DC or PoE (IEEE 802.3af class 1). The KNX Standard Communication (Multicast) can be switched off. In this case, up to 10 IPR/S 3.5.1 can communicate using unicast communication.

Description	Mod. width	Order details		Price	Weight	Pack
		Type code	Order code	1 piece	1 piece	unit
				€	kg	pc.
	2	IPR/S 3.5.1	2CDG110176R0011		0.11	1



IPR/S 3.1.1

IP Router, MDRC

Connects the KNX bus with the Ethernet network. The device uses the KNXnet/IP protocol for communication (Routing and Tunneling). It can be used as a fast line and area coupler. The full filter table for main groups 0-31 is supported. KNX devices can be programmed via the LAN using ETS. For this and further clients 5 Tunneling Servers are available. The IP address can be fixed or can be received from a DHCP server. Power supply via 12...30 V DC or PoE (IEEE 802.3af class 1). The KNX Standard Communication (Multicast) can be switched off. In this case, up to 10 IPR/S 3.1.1 can communicate using unicast communication.

Description	Mod. width	Order details		Price	Weight	Pack
		Type code	Order code	1 piece	1 piece	unit
				€	kg	pc.
	2	IPR/S 3.1.1	2CDG110175R0011		0.11	1

ABB i-bus® KNX

System Infrastructure and Interfacing



IPS/S 3.5.1

IP Interface Secure, MDRC

Connects the KNX bus with the Ethernet network and encrypts communication. The device uses the KNXnet/IP Secure protocol for communication (Tunneling). KNX devices can be programmed via the LAN using ETS. For this and further clients 5 Secure Tunneling Servers are available. The IP address can be fixed or can be received from a DHCP server. Power supply via 12...30 V DC or PoE (IEEE 802.3af class 1).

Description	Mod. width	Order details		Price	Weight	Pack unit
		Type code	Order code	1 piece	1 piece	
		€	kg	pc.		
	2	IPS/S 3.5.1	2CDG110204R0011	0.11	1	



IPS/S 3.1.1

IP Interface, MDRC

Connects the KNX bus with the Ethernet network. The device uses the KNXnet/IP protocol for communication (Tunneling). KNX devices can be programmed via the LAN using ETS. For this and further clients 5 Tunneling Servers are available. The IP address can be fixed or can be received from a DHCP server. Power supply via 12..30 V DC or PoE (IEEE 802.3af class 1).

Description	Mod. width	Order details		Price	Weight	Pack unit
		Type code	Order code	1 piece	1 piece	
		€	kg	pc.		
	2	IPS/S 3.1.1	2CDG110177R0011	0.11	1	



IS/S 8.1.1

IP Switch, 8 Ports, Fast Ethernet, MDRC

The IP Switch is an industrial-grade, 8 Ports, Fast Ethernet (100 Mbit/s), unmanaged switch with plug-and-play capabilities, designed for installation in electrical distribution boards and small housings for rapid mounting on 35 mm DIN rails (to EN 60715).

Description	Mod. width	Order details		Price	Weight	Pack unit
		Type code	Order code	1 piece	1 piece	
		€	kg	pc.		
	8	IS/S 8.1.1	2CDG120082R0011	0.25	1	



ISP/S 8.1.1.1

IP Switch PoE, 8 Ports, Fast Ethernet, 55W, MDRC

The IP Switch PoE is an industrial-grade, 8 Ports, Fast Ethernet (100 Mbit/s), PoE (55 W), unmanaged switch with plug-and-play capabilities, designed for installation in electrical distribution boards and small housings for rapid mounting on 35 mm DIN rails (to EN 60715).

Description	Mod. width	Order details		Price	Weight	Pack unit
		Type code	Order code	1 piece	1 piece	
		€	kg	pc.		
	12	ISP/S 8.1.1.1	2CDG120083R0011	0.41	1	



IPM/S 1.1

IP Patch Module, MDRC

The IP Patch Module consists of an RJ-45 module and a mounting adapter for rail mounting.

Description	Mod. width	Order details		Price	Weight	Pack
		Type code	Order code	1 piece	1 piece	unit
				€	kg	pc.
	1	IPM/S 1.1	2CDG120036R0011		0.1	1



USB/S 1.2

USB Interface, MDRC

Connects the KNX installation with PC software clients such as ETS or visualisations (programming, bus monitor, group monitor). The device supports Long Frames which allows faster download and download of KNX Secure devices.

Description	Mod. width	Order details		Price	Weight	Pack
		Type code	Order code	1 piece	1 piece	unit
				€	kg	pc.
	2	USB/S 1.2	2CDG110243R0011		0.08	1



LL/S 1.1

Optical Fibre Interface, MDRC

The device is used to couple two sections of an bus line using an optical fibre link. Ideal for bridging longer distances or to avoid having to implement lightning and overvoltage protection when laying cables between buildings. Two devices are needed to complete a transmission link.

Description	Mod. width	Order details		Price	Weight	Pack
		Type code	Order code	1 piece	1 piece	unit
				€	kg	pc.
	4	LL/S 1.1	GHQ6050053R0001		0.28	1



MG/S 11.100.1.1

Modbus RTU Master – KNX TP Gateway, 100 Points, MDRC

NEW

The Modbus KNX Gateway integrates Modbus RTU slave devices with KNX installations at field level. The devices support standard KNX data points (DPT) and up to 100 communication objects. The device is put into operation with the ETS. An optional, free-of-charge ETS app (DCA) is available to facilitate the configuration, allowing to export, and import Modbus-KNX mapping in the form of templates. Modbus component templates will also be available for download from a database. Auxiliary voltage is not required.

Available March 2023

Description	Mod. width	Order details		Price	Weight	Pack
		Type code	Order code	1 piece	1 piece	unit
				€	kg	pc.
	2	MG/S 11.100.1.1	2CDG120089R0011			1

ABB i-bus® KNX

Connection and Wiring



DSM/S 1.1

Diagnosis and Protection Module, MDRC

Enables quick diagnosis of the bus state and indicates telegram traffic via an LED. A bus fault is indicated by contacts. The DSM also suppresses transient overvoltages and interference voltage spikes on the bus and thus protects the connected devices.

Description	Mod. width	Order details		Price	Weight	Pack unit
		Type code	Order code	1 piece	1 piece	
				€	kg	pc.
	2	DSM/S 1.1	2CDG110060R0011		0.11	1



SPD/S 1.1

Surge Protective Device

KNX surge protective devices are capable of discharging direct & indirect lightning strikes causing induced or conducted overvoltages between lines (differential) and lines to ground (common mode) and are safely kept well below the withstand voltages of the KNX system. They are installed between buildings or KNX zones to provide safe isolation from surges. End of life protection indication is provided from the pushbutton, simply depress the pushbutton and make sure green indicator illuminates. If no indication then replacement is required.

Description	Mod. width	Order details		Price	Weight	Pack unit
		Type code	Order code	1 piece	1 piece	
				€	kg	pc.
	2	SPD/S 1.1	7TCA085400R0448		0.1	1



VB/K ...

Wiring Jumpers

For the interconnection of devices with a bus connection terminal. The vertical and horizontal versions are matched to typical wiring applications.

Description	Mod. width	Order details		Price	Weight	Pack unit
		Type code	Order code	1 piece	1 piece	
				€	kg	pc.
horizontal, 100 mm	–	VB/K 100.1	GHQ6301908R0003		0.06	10
horizontal, 200 mm	–	VB/K 200.1	GHQ6301908R0001		0.07	10
vertical, 270 mm	–	VB/K 270.1	GHQ6301908R0002		0.11	10
vertical, 360 mm	–	VB/K 360.1	GHQ6301908R0004		0.16	10



PS 1/4/6-KNX

Busbars

Busbar for connection several floating supply contacts of a device (e.g. SD/S, SA/S, ...). Reducing the wiring effort and create a secure load-connection. The PS1/4/6 is ready assembled and can be used immediately. The PS 1/60/6 is cut to the required length and closed with the end cap PS-END 1-S.



PS-END 1-S

Description	Mod. width	Order details		Price	Weight	Pack unit
		Type code	Order code	1 piece	1 piece	
				€	kg	pc.
1 Phase, 4 Contacts	–	PS 1/4/6-KNX	2CDG924003R0011		0.012	10
1 Phase, 60 Contacts	–	PS 1/60/6-KNX	2CDG924004R0011		0.11	1
End Cap for busbar	–	PS-END 1-S	2CDL000001R0001		0.001	25



US/E 1

Connection Terminals

For connecting bus devices as well as for looping through or branching the bus cable. Available in black/red for use as bus connecting terminal, in blue as bus connecting terminal with surge protector and in white/yellow for use as a connecting terminal.

Description	Mod. width	Order details		Price	Weight	Pack
		Type code	Order code	1 piece	1 piece	unit
				€	kg	pc.
Bus Connection Terminal, 50 Pieces, black/red	-	BUSKLEMME	GHQ6301901R0001		0.01	50
Connection Terminal, 50 Pieces, white/yellow	-	KLEMME	GHQ6301902R0001		0.01	50
Connection Terminal with Surge Arrester	-	US/E 1	GHQ6310009R0001		0.01	1



STR/Z 1.50.1

Label Carrier for DIN-rail Devices, 50 Pieces

Snap-on label carrier consisting of transparent carrier plate and insertable blank paper labels.

Description	Mod. width	Order details		Price	Weight	Pack
		Type code	Order code	1 piece	1 piece	unit
				€	kg	pc.
	-	STR/Z 1.50.1	2CDG110149R0011		0.04	50

ABB i-bus® KNX

Multifunction Room Automation –
Room Controller

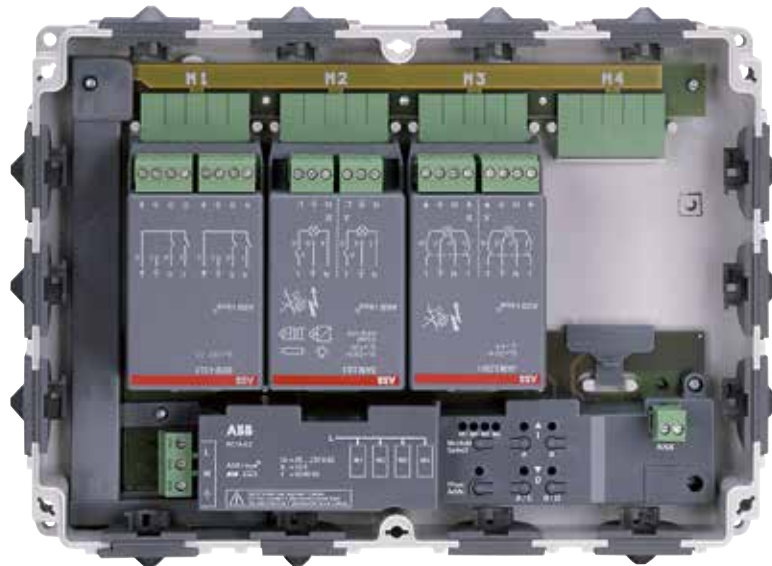

The fundamental principle:**One device per room**

A single Room Controller controls all the room functions.

This “one device per room” principle economically and flexibly provides KNX functionality: With 4 or 8 modules, which are simply inserted into the basis device, all loads in this room (lights, blinds, heating, etc.) can be controlled.

Economic security from the outset

The installation concept of the Room Controller, particularly the simple plug-in module concept, provides security and reliability.

- **When planning the infrastructure of a building:**

- It can be undertaken without exact knowledge of the subsequent user demands.

- **During commissioning:**

- When user demands have been determined, they are implemented by simple insertion of modules.

- **In operation in a building:**

- Modifications to the room utilisation are easy to implement.
- The changes to the cable routing are limited to the room concerned.

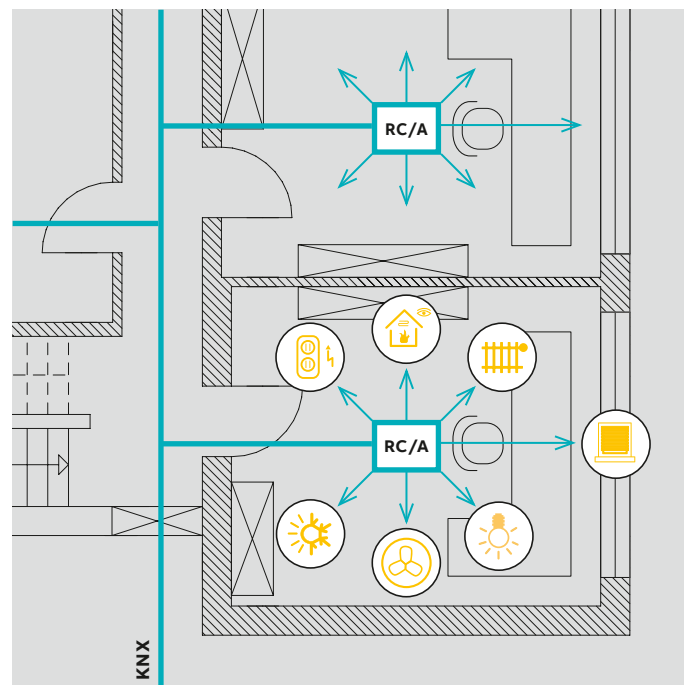
**Improved fire protection included**

The significant reduction in the wiring also considerably reduces the fire load and thus improves safety for persons and assets.

Save on energy and not on comfort

Each room is used differently. The different module assignments of the Room Controller can be configured accordingly.

Just three examples of special building functions that can be implemented with the device.

In the lighting sector

Constant lighting control is not the only conceivable solution. A high level of comfort can be assured by the control of different light scenes.

Blinds and roller shutters

Not only do they provide pleasant shading, they also assist in responsible use of energy. Intelligent facade controls move the blinds to suit the position of the sun.

Heating/Ventilation/Air conditioning

The control of electrothermal valves on radiators is no problem for the “electronic switch actuator” module of the Room Controller. The ventilation can also be integrated into this automatic control.

ABB i-bus® KNX

Multifunction Room Automation – Room Controller

Overview of switching performance

	SA/M 2.6.1	SA/M 2.16.1	SD/M 2.6.2	LR/M 1.6.2	UD/M 1.300.1	ES/M 2.230.1	ES/M 2.24.1
Outputs							
Load circuits	2 relay outputs	2 relay outputs, floating	2 relay outputs	1 relay output	Semiconductor output, dimmed via phase interval or phase control	2 semiconductor outputs for resistive loads, inrush current: max. 1 A, continuous current: max. 700 mA	2 semiconductor outputs for resistive loads, inrush current: max. 1 A, continuous current: max. 700 mA
U _n rated voltage	250/440 V AC	250/440 V AC	250/440 V AC	250/440 V AC	115/230 V AC	115/230 V AC	24 V AC/DC
I _n rated current	6 AX	16 A	6 AX	6 AX		700 mA	700 mA
Control outputs	–	–	2 x 1...10 V DC (passive)	1 x 1...10 V DC (passive)	–	–	–
Max. control current	–	–	30 mA	30 mA	Max. output power 300 VA at 230 V AC 150 VA at 127 V AC Min. output power: 2 VA	–	–
Max. cable length	–	–	100 m	100 m	–	–	–
Switching current per output							
AC3 operation (cos φ = 0.45) EN 60 947-4-1	6 A / 230 V	8 A / 230 V	6 A / 230 V	6 / 230 V	–	–	–
AC1 operation (cos φ = 0.45) EN 60 947-4-1	6 A / 230 V	16 A / 230 V	6 A / 230 V	6 A / 230 V	–	–	–
Fluorescent lighting load AX to EN 60 669	6 A / 250 V (70 μF)	16 A / 250 V (70 μF)	6 A / 250 V (70 μF)	6 A / 250 V (70 μF)	–	–	–
Minimum switching capacity	100 mA / 12 V 100 mA / 24 V	100 mA / 12 V 100 mA / 24 V	100 mA / 12 V 100 mA / 24 V	100 mA / 12 V 100 mA / 24 V	–	–	–
DC current switching capacity (resistive load)	6 A / 24 V=	16 A / 24 V=	6 A / 24 V=	6 A / 24 V=	–	–	–

– = Not applicable

Overview of switching performance

	SA/M 2.6.1	SA/M 2.16.1	SD/M 2.6.2	LR/M 1.6.2	UD/M 1.300.1	ES/M 2.230.1	ES/M 2.24.1
Lamp loads at 230 V AC							
– Incandescent lamp load	1380 W	2300 W	1380 W	1380 W	–	–	–
Fluorescent lamps T5 / T8							
– Uncompensated	1380 W	2300 W	1380 W	1380 W	–	–	–
– Parallel compensated	1380 W	1500 W	1380 W	1380 W	–	–	–
– DUO connection	1380 W	1500 W	1380 W	1380 W	–	–	–
Low-volt halogen lamps							
– Inductive transformer	1200 W	1200 W	1200 W	1200 W	–	–	–
– Electronic transformer	1380 W	1500 W	1380 W	1380 W	–	–	–
– Halogen lamp 230 V	1380 W	2300 W	1380 W	1380 W	–	–	–
Dulux lamp							
– Uncompensated	1100 W	1100 W	1100 W	1100 W	–	–	–
– Parallel compensated	1100 W	1100 W	1100 W	1100 W	–	–	–
Mercury-vapour lamp							
– Uncompensated	1380 W	2000 W	1380 W	1380 W	–	–	–
– Parallel compensated	1380 W	2000 W	1380 W	1380 W	–	–	–
Switching capacity							
– Max. peak inrush-current I _p (150 μs)	400 A	400 A	400 A	400 A	–	–	–
– Max. peak inrush-current I _p (250 μs)	320 A	320 A	320 A	320 A	–	–	–
– Max. peak inrush-current I _p (600 μs)	200 A	200 A	200 A	200 A	–	–	–
Number of electronic ballasts (T5/T8, single element)							
– 18 W (ABB EVG 1x18 CF)	23	23	23	23	–	–	–
– 24 W (ABB EVG-T5 1x24 CY)	23	23	23	23	–	–	–
– 36 W (ABB EVG 1x36 CF)	14	14	14	14	–	–	–
– 58 W (ABB EVG 1x58 CF)	11	11	11	11	–	–	–
– 80 W (Helvar EL 1x80 SC)	10	10	10	10	–	–	–

Further technical specifications can be found in the corresponding product manuals at www.abb.com/knx

– = Not applicable

ABB i-bus® KNX

Multifunction Room Automation – Room Controller Basis Devices



Configuration example

Room Controller

The Room Controller controls all the functions in the room as a central device. Due to its modular design, it can be adapted flexibly to the required functionality. On-site installation enables short assembly and commissioning times. A structured cable entry creates clarity and flexibility for changes in function – both during planning and operation.

Special features

- Height 50 mm: optimised for underfloor installation or suspended ceilings
- Room Controller counts as just one bus device
- Robust housing, IP 54 degree of protection
- Manual operation for immediate testing – even without bus voltage
- Comprehensive software functionality



RC/A 4.2

Room Controller, Basis Device for 4 Modules, SM

It accommodates up to 4 plug-in modules and controls their functions. The RC/A 4.2 communicates as a bus device. Any module type can be plugged into each module slot. A manual control for module function test is integrated. Dimensions: (H x W x D) 200 x 275 x 50.

Description	Mod. width	Order details		Price	Weight	Pack unit
		Type code	Order code	1 piece	1 piece	
	–	RC/A 4.2	2CDG110104R0011	€	kg	pc.
					0.98	1



RC/A 8.2

Room Controller, Basis Device for 8 Modules, SM

It accommodates up to 8 plug-in modules and controls their functions. Any module type can be plugged into each module slot. The inserted module is automatically detected. The manual operation facility enables an immediate function test even when bus voltage is not applied. Dimensions: (H x W x D) 270 x 316 x 50.

Description	Mod. width	Order details		Price	Weight	Pack unit
		Type code	Order code	1 piece	1 piece	
	–	RC/A 8.2	2CDG110106R0011	€	kg	pc.
					1.695	1

ABB i-bus® KNX

Multifunction Room Automation – Room Controller Function Modules



BE/M 4.230.1

Binary Input Modules, 4-fold

Each of the modules provides 4 inputs. There are 3 module types available for the connection of 115/230 V, 12/24 V (AC or DC) or floating contacts to cover all demands.

Description	Mod. width	Order details		Price	Weight	Pack
		Type code	Order code	1 piece	1 piece	unit
				€	kg	pc.
230 V	–	BE/M 4.230.1	2CDG110005R0011		0.13	1
12/24 V	–	BE/M 4.24.1	2CDG110006R0011		0.13	1
Contact Scanning	–	BE/M 4.12.1	2CDG110007R0011		0.13	1



SA/M 2.6.1

Switch Actuator Module, 2-fold, 6 A

For switching loads up to 16 A at a maximum continuous current of 6 A.

Description	Mod. width	Order details		Price	Weight	Pack
		Type code	Order code	1 piece	1 piece	unit
				€	kg	pc.
	–	SA/M 2.6.1	2CDG110002R0011		0.17	1



SA/M 2.16.1

Switch Actuator Module, 2-fold, 16 A

Switches up to 16 A with two floating relay contacts. The feeding voltage is independent from the Room Controller Basis Device. It must thus be applied directly to the module.

Description	Mod. width	Order details		Price	Weight	Pack
		Type code	Order code	1 piece	1 piece	unit
				€	kg	pc.
	–	SA/M 2.16.1	2CDG110100R0011		0.16	1



JA/M 2.230.1

Shutter Actuator Modules, 2-fold

For controlling two independent blind or shutter drives. There are two module types available for 115/230 V AC or 24 V DC drives.

Description	Mod. width	Order details		Price	Weight	Pack
		Type code	Order code	1 piece	1 piece	unit
				€	kg	pc.
230 V AC	–	JA/M 2.230.1	2CDG110003R0011		0.17	1
24 V DC	–	JA/M 2.24.1	2CDG110004R0011		0.17	1



SD/M 2.6.2

Switch/Dim Actuator Module, 2-fold, 6 AX

It enables the switching and dimming of two groups of luminaries in conjunction with electronic ballasts via a 1...10 V control voltage.

Description	Mod. width	Order details		Price	Weight	Pack
		Type code	Order code	1 piece	1 piece	unit
				€	kg	pc.
	–	SD/M 2.6.2	2CDG110107R0011		0.17	1

ABB i-bus® KNX

Multifunction Room Automation – Room Controller Function Modules



LR/M 1.6.2

Light Controller Module, 1-fold, 6 AX

Enables the switching and dimming of one group of luminaires via a 1...10 V control voltage. The device can be used for constant lighting control in connection with a Light Sensor LF/U 2.1.

Description	Mod. width	Order details		Price	Weight	Pack
		Type code	Order code	1 piece	1 piece	unit
				€	kg	pc.
	–	LR/M 1.6.2	2CDG110108R0011		0.13	1



UD/M 1.300.1

Universal Dim Actuator Module, 1-fold, 300 VA

For dimming incandescent lamps, 230 V or low-voltage halogen lamps up to 300 W/VA. The automatic load detection detects the connected load and optimises the control. The minimum load is just 2 W.

Description	Mod. width	Order details		Price	Weight	Pack
		Type code	Order code	1 piece	1 piece	unit
				€	kg	pc.
	–	UD/M 1.300.1	2CDG110012R0011		0.18	1



ES/M 2.230.1

Electronic Switch Actuator Module, 2-fold

With 2 overload-proof outputs for noiseless control of heating systems and chilled ceilings via thermoelectric valve drives. Two module types for voltages from 115/230 V or 24 V (AC or DC) are available.

Description	Mod. width	Order details		Price	Weight	Pack
		Type code	Order code	1 piece	1 piece	unit
				€	kg	pc.
115/230 V	–	ES/M 2.230.1	2CDG110013R0011		0.15	1
24 V	–	ES/M 2.24.1	2CDG110014R0011		0.15	1

ABB i-bus® KNX

Multifunction Room Automation – Room Master

	Room Master Basic RM/S 1.1	Room Master Premium RM/S 2.1	Room Master RM/S 3.1	Room Master RM/S 4.1
General				
Supply voltage	KNX	KNX	KNX	KNX
Type of installation	DIN-Rail	DIN-Rail	DIN-Rail	DIN-Rail
Module width (18 mm)	8	12	12	8
Current consumption, bus	< 12 mA	< 24 mA	< 12 mA	< 12 mA
Inputs				
Binary inputs (for potential free contacts via contact scanning)	8	18	12	8
Outputs				
Switching capacity 20 A (16 AX) ¹⁾	1	3	4	–
Switching capacity 16 A (10 AX) ²⁾	2	1	–	–
Switching capacity 6 A ³⁾	3 (configurable as switch or fan outputs)	12 (3 configurable as switch or fan outputs)	–	8
0.5 A electronic (for max. 2 electrothermal or motor valve drive controls)	2	2	–	–
6 A changeover contact (Blind or Shutter control)	–	1	4 (configurable also as switch outputs)	–
Functions				
Lighting control (Switching)	■	■	■	■
Heating/Cooling (Electrothermal or motor valve drive control, 3-level fan speed control)	■	■	■	■
Shading control (Shutter, blinds or curtains)	–	■	–	–
Control of further loads via switched electrical sockets	■	■	■	■
Internal connection of inputs and outputs without group addresses	■	■	■	■
Scenes	■	■	■	■
Room scenarios	■	■	■	■
Application with preconfigured inputs and outputs	■	■	–	–
Programmable with predefined and tested example projects (ETS 4) for different fields of application (office, schools, hotel rooms, ...)	–	–	■	–
Planning templates	–	–	■	–

■ = Function is supported

– = Function is not supported

1) = Switching capacity, see Switch Actuators SA/S x.16.5.1

2) = Switching capacity, see Switch Actuators SA/S x.10.2.1

3) = Switching capacity, see Switch Actuators SA/S x.6.1.1

ABB i-bus® KNX

Multifunction Room Automation – Room Master



RM/S 1.1



RM/S 2.1



RM/S 3.1



RM/S 4.1

Room Master

The Room Master is a KNX device with a combination of inputs and outputs. The quantities, technical data and the functions of these inputs and outputs are compiled, so that overall control of all the functions in rooms of a live-in character or apartments, are implemented via a device. Typical areas of application of the Room Master are hotel rooms, hospital rooms as well as apartments in institutions for residential care or in student residential homes. The Room Master with its compact design covers all the basic requirements for Lighting control, Heating/Air conditioning, Shading control (shutters, blinds or curtains - with the RM/S 2.1) and Control of further loads via switched electrical sockets. Function extensions are possible at any time, e.g. devices for dimming via ABB i-bus® KNX.

Overview of the inputs and outputs

	RM/S 1.1	RM/S 2.1	RM/S 3.1	RM/S 4.1	Application possibilities
Binary inputs via contact scanning	8	18	12	8	For connection of switches or push-buttons (light on/off, shutter up/down, etc.) or sensors (window contacts, door contacts, water sensors, condensation water sensors, hotel card readers, etc.)
Outputs 20 A (16 AX)	1	3	4	–	Bathroom fan, switching of electrical sockets
Outputs 16 A (10 AX)	2	1	–	–	Auxiliary electrical heating of fan-coil units (at RM/S 1.1 and 2.1), lighting
Outputs 6 A	3	12	–	8	3-speed fan control (at RM/S 1.1 and 2.1), lighting
Outputs 0.5 A electronic	2	2	–	–	Valve control (heating, cooling) for max. 2 separate valves
Outputs 6 A changeover contact	–	1	4 (configurable as switch outputs too)	–	Blind or roller blind control

- RM/S 1.1 and RM/S 2.1 are preprogrammed ex factory
- RM/S 3.1 and RM/S 4.1 are programmable with predefined and tested example projects (ETS 4) for different fields of application (office, schools, hotel rooms, ...)
- Commissioning of the preprogrammed devices on the construction site without notebook and ETS programming. With the electrical connection all room functions are available.
- Optional functional extensions via integration into KNX networks with ETS software.

Further information about Room Master on www.abb.com/knx

Description	Mod. width	Order details		Price 1 piece	Weight 1 piece	Pack unit
		Type code	Order code			
	8	RM/S 1.1	2CDG110094R0011		0.45	1
	12	RM/S 2.1	2CDG110095R0011		0.76	1
	12	RM/S 3.1	2CDG110165R0011		0.55	1
	8	RM/S 4.1	2CDG110170R0011		0.3	1

ABB i-bus® KNX Inputs



ABB i-bus® KNX

Inputs

Wide-range inputs and a streamlined range – The ABB i-bus® KNX Binary Inputs.

ABB i-bus® KNX Binary Inputs serve as an interface for operation of KNX systems via conventional push buttons and switches as well as for processing binary signals (signalling contacts).

In contrast to the existing solutions, where the input voltages of 24 V and 230 V required separate devices, the Binary Inputs now feature **wide-range inputs**, which can process voltage signals ranging from 10 to 230 V AC/DC. This offers the **installer significantly greater flexibility**.

In addition to two devices with 4 and 8 wide-range inputs, the ABB i-bus® KNX Binary Input product range is rounded off by two devices with 4 and 8 inputs with scanning voltage. On these types, a pulsed scanning voltage is provided for connection of floating contacts from the device.

With an identical range of applications, the number of ABB i-bus® KNX Binary Inputs is now reduced from 6 types to 4.

All Binary Inputs feature **a high-quality membrane keypad for comfortable manual operation and display of the device functions**. Input states can be simulated at the device, so that the conventional push buttons, switches or floating contacts do not need to be connected for commissioning purposes. The device functions can be easily tested during commissioning in this way.

The Binary Inputs are powered via the KNX and do not require an additional power supply.

The software functionality of the Binary Inputs has also been extended. It is now possible to send **several switching telegrams with just a single push of a button**.

Especially useful, just as in the case of the Switch Actuators, it is also possible **to copy the channels of the device in the ETS**. The parameters and group addresses of a channel can be simply transferred to other channels in this way. This simplifies project engineering and helps reduce sources of error.



Application

- Operation of KNX systems via conventional push buttons and switches
- Processing of binary signals (signalling contacts)

Benefits

- Flexible application due to wide-range inputs
- Reduced stock requirement due to streamlined product range
- Simplified commissioning using the copy function

Product

- BE/S 4.20.2.1 with 4 inputs for contact scanning and manual operation
- BE/S 4.230.2.1 with 4 wide-range inputs and manual operation
- BE/S 8.20.2.1 with 8 inputs for contact scanning and manual operation
- BE/S 8.230.2.1 with 8 wide-range inputs and manual operation

	BE/S 4.20.2.1	BE/S 4.230.2.1	BE/S 8.20.2.1	BE/S 8.230.2.1	US/U 2.2	US/U 4.2	US/U 12.2
General							
Voltage range	–	10...230 V	–	10...230 V	–	–	–
Voltage type	–	AC/DC	–	AC/DC	–	–	–
Contact scanning	■	–	■	–	■	■	■
Inputs	4	4	8	8	2	4	12
Type of installation	DIN-Rail	DIN-Rail	DIN-Rail	DIN-Rail	FM	FM	FM
Module width (space unit)	2	2	4	4	–	–	–
Switch sensor							
Send switch value after any edge	■	■	■	■	■	■	■
Send switch value after signal length and/or cyclically	■	■	■	■	■	■	■
Send switch value 1 cyclically	■	■	■	■	■	■	■
Send switch value 2	■	■	■	–	–	–	–
Send switch value 3	■	■	■	–	–	–	–
Difference between short and long operation	■	■	■	■	■	■	■
Dim sensor							
Start-stop dimming, step-by-step dimming	■	■	■	■	■	■	■
One-touch dimming	■	■	■	■	■	■	■
Shutter Sensor							
Shutter operation via a push button/switch	■	■	■	■	■	■	■
Shutter operation via two push buttons/switches	■	■	■	■	■	■	■
Value/Forced operation							
1 bit [0/1], 2 bit forced operation	■	■	■	■	■	■	■
1/2/4 bytes	■	■	■	■	■	■	■
Signed	■	■	■	■	–	–	–
3 byte, time, weekday	■	■	■	■	–	–	–
Control scene							
8 bit scene	■	■	■	■	■	■	■
Store scene	■	■	■	■	■	■	■
Switching sequence							
Several preset sequences can be set	■	■	■	■	■	■	■
Link several push buttons in a switching sequence (actuating number)	■	■	■	■	■	■	■

■ = Function is supported

– = Function is not supported

ABB i-bus® KNX

Inputs

	BE/S 4.20.2.1	BE/S 4.230.2.1	BE/S 8.20.2.1	BE/S 8.230.2.1	US/U 2.2	US/U 4.2	US/U 12.2
Multiple operation							
Telegram for long operation	■	■	■	■	■	■	■
Multiple operation can be set	■	■	■	■	■	■	■
Pulse counter							
Adjustable data type and threshold values	■	■	■	■	■	■	-
Temporary counter activation	■	■	■	■	■	■	-
Send counter level cyclically	■	■	■	■	■	■	-
Manual operation							
Energy-saving mode	■	■	■	■	-	-	-
Enable/release manual operation	■	■	■	■	-	-	-
Manual operating status	■	■	■	■	-	-	-
Enable/release manual operation button per input	■	■	■	■	-	-	-
Input LED can be inverted	■	■	■	■	-	-	-
Special functions							
Copying and exchanging parameter settings	■	■	■	■	-	-	-
Enable/disable input	■	■	■	■	■	■	■
Adjustable debounce time and minimum signal time	■	■	■	■	■	■	■
Limit the number of telegrams	■	■	■	■	■	■	■
Device sends an "In operation" telegram	■	■	■	■	-	-	-
Heating valve control (electric relay)	-	-	-	-	■	■	■
Switch LEDs	-	-	-	-	■	■	■

- ■ = Function is supported
 - = Function is not supported



BE/S 8.230.2.1

Binary Inputs, 10 – 230 V, MDRC

Detects AC/DC signals in the voltage range from 12...230 V. The state of the input is displayed via yellow LEDs. The binary inputs enable detection of independent input signals. The devices feature a manual operation pushbutton for each channel. The devices are powered via the ABB i-bus® and do not require an additional power supply.

Description	Mod. width	Order details		Price	Weight	Pack
		Type code	Order code	1 piece	1 piece	unit
				€	kg	pc.
4-fold	2	BE/S 4.230.2.1	2CDG110091R0011		0.12	1
8-fold	4	BE/S 8.230.2.1	2CDG110093R0011		0.23	1



BE/S 4.20.2.1

Binary Inputs, Contact Scanning, MDRC

Scans floating contacts with internally generated scanning voltage. The state of the input is displayed via yellow LEDs. The binary inputs enable detection of independent input signals. The devices feature a manual operation pushbutton for each channel. The devices are powered via the ABB i-bus® and do not require an additional power supply.

Description	Mod. width	Order details		Price	Weight	Pack
		Type code	Order code	1 piece	1 piece	unit
				€	kg	pc.
4-fold	2	BE/S 4.20.2.1	2CDG110090R0011		0.12	1
8-fold	4	BE/S 8.20.2.1	2CDG110092R0011		0.23	1



US/U 4.2

Universal Interface, FM

The universal interface has 2, 4 or 12 channels which can be parametrised as inputs or outputs with the ETS software. Conventional push-buttons, auxiliary contacts, LEDs and the electronic relay ER/U can be connected. The connecting cables can be extended up to 10 m. The contact scanning voltage and the supply voltage for the LEDs are made available by the device, the series resistors for the LEDs are integrated.

Description	Mod. width	Order details		Price	Weight	Pack
		Type code	Order code	1 piece	1 piece	unit
				€	kg	pc.
2-fold	–	US/U 2.2	GHQ6310074R0111		0.06	1
4-fold	–	US/U 4.2	GHQ6310070R0111		0.06	1
12-fold	–	US/U 12.2	2CDG110065R0011		0.06	1

ABB i-bus® KNX

Inputs



AE/S 4.1.1.3



AE/A 2.1



WZ/S 1.3.1.2



WES/A 3.1



WS/S 4.1.1.2

Analogue Input

Used wherever analogue variables should be detected. The sophisticated housing concept of the surface mounted device and the screw terminals of the DIN-Rail device enable quick and clear wiring and improve the speed of connection of the sensors.

Comprehensive range of adjustment for many typical sensors (1 – 10 V, 0(4) – 20 mA, 0 – 1 V, PT 100, PT 1000,...) for detection of temperature, brightness, fill levels, etc.

For active sensors the auxiliary voltage is supplied by AE/S 4.1.1.3; in case of AE/A 2.1 a separate auxiliary voltage supply is required.

Description	Mod. width	Order details		Price	Weight	Pack
		Type code	Order code	1 piece	1 piece	unit
				€	kg	pc.
4-fold, MDRC	4	AE/S 4.1.1.3	2CDG110190R0011		0.27	1
2-fold, SM	–	AE/A 2.1	2CDG110086R0011		0.30	1

Weather Unit, MDRC and Weather Sensor, SM

It is used to detect and process weather data from weather sensor. It supplies data for twilight and brightness levels in 3 directions, rain, temperature, information on day/night, wind speed, date and time. An additional input for the connection of a PT - 1000 sensor is provided. Four value memories which can store up to 24 values each are available. The Weather Unit WZ/S 1.3.1.2 can be operated either with the new Weather Sensor WES/A 3.1 or with the former sensor WES/A 2.1. The Weather Unit also provides the supply voltage for the connected sensor. The Weather Unit has to be supplied with a operating voltage of 85 to 265 V AC. The Weather Unit supports the ABB i-bus® Tool for advanced diagnosis and improved commissioning.

The Weather Sensor WES/A 3.1 detects twilight, brightness in three directions, rain, temperature, day/night, wind speed and the date and time using a GPS module. An additional heating transformer is not required. The new Weather Sensor WES/A 3.1 can be connected to the new Weather Unit WZ/S 1.3.1.2 or to the former Weather Unit WZ/S 1.1.

Description	Mod. width	Order details		Price	Weight	Pack
		Type code	Order code	1 piece	1 piece	unit
				€	kg	pc.
Weather Unit	4	WZ/S 1.3.1.2	2CDG110184R0011		0.20	1
Weather Sensor	–	WES/A 3.1	2CDG120046R0011		0.17	1

Weather Station, 4-fold, MDRC

All common weather sensors for wind speed, wind direction, rain, amount of rain, brightness, light intensity, pyranometers, twilight, air pressure, humidity or temperature can be connected to the device. The power supply generates the 24 V DC voltage for external sensors (max. 300 mA). The device can be operated with 85 to 265 V AC, 50/60 Hz. The application software is configured for the detection of weather based data and enables quick sensor programming. The Weather Station supports the ABB i-bus® Tool for advanced diagnosis and improved commissioning.

Description	Mod. width	Order details		Price	Weight	Pack
		Type code	Order code	1 piece	1 piece	unit
				€	kg	pc.
	4	WS/S 4.1.1.2	2CDG110191R0011		0.27	1

Outputs

Switch to a smarter tomorrow

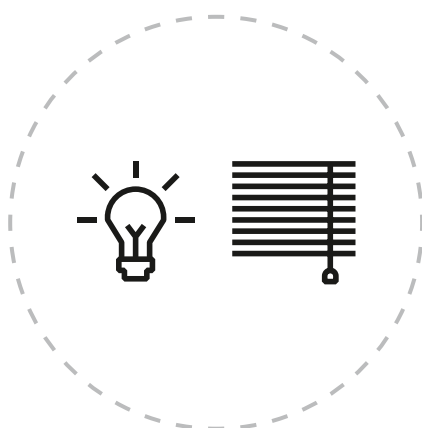

Combi Switch Actuators

The 9 Combi devices are combining two applications: switching and shading. The products are ideally made for residential usage to offer greatest flexibility.

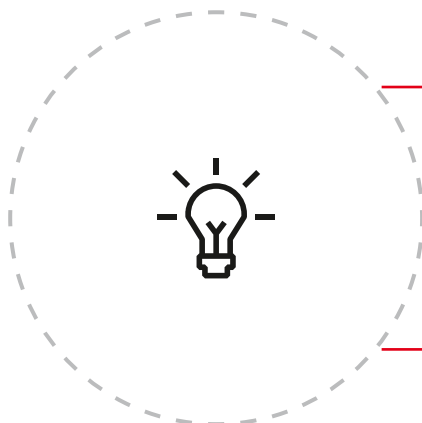

Standard Switch Actuators

These 12 devices are building the Standard when it comes to switching applications for commercial buildings. During the development we focused on providing a cost optimized selection of products, that matches the needs of commercial projects.

Professional Switch Actuators

The professional series includes 8 switch actuators made for high switching capacity. This portfolio has been developed to suit the high requirements of industry standards.

ABB i-bus® KNX

Outputs – Combi Switch Actuators

The following table provides an overview of the rated values, switching performance, lamp loads or the number of lamps, which can be connected to a contact:

	SAH/S 8.6.7.1 SAH/S 16.6.7.1 SAH/S 24.6.7.1	SAH/S 8.10.7.1 SAH/S 16.10.7.1 SAH/S 24.10.7.1	SAH/S 8.16.7.1 SAH/S 16.16.7.1 SAH/S 24.16.7.1
Range	Combi	Combi	Combi
I_n rated current (A)³⁾	6 A	10 A ⁵⁾	16 A ⁵⁾
U_n rated voltage (V)	230 V AC	230 V AC	230 V AC
AC1 operation (cos φ = 0.8) acc. to EN 60947-4-1	6 A	10 A	16 A
AC3 operation (cos φ = 0.45) acc. to EN 60947-4-1	6 A	6 A	6 A
C-Load switching capacity (200 μF)	–	–	–
Fluorescent lighting load AX acc. to EN 60669-1	6 AX (140 μF) ¹⁾	10 AX (140 μF) ¹⁾	10 AX (140 μF) ¹⁾
Minimum switching capacity	100 mA/12 V	100 mA/12 V	100 mA/12 V
DC current switching capacity (resistive load)	6 A/24 V =	6 A/24 V =	6 A/24 V =
Mechanical service life	> 10 ⁶	> 10 ⁶	> 10 ⁶
Electronic endurance to IEC 60947-4-1:			
– Rated current AC1 (240 V/cos φ = 0.8)	100,000	100,000	100,000
– Rated current AC3 (240 V/cos φ = 0.45)	6,000	6,000	6,000
Incandescent lamp load at 230 V AC	1,200 W	1,200 W	1,200 W
Fluorescent lamp T5 / T8:			
– Uncorrected	800 W	800 W	800 W
Low-voltage halogen lamps:			
– Inductive transformer	800 W	800 W	800 W
– Electronic transformer	1,000 W	1,000 W	1,000 W
Halogen lamp 230 V	1,000 W	1,000 W	1,000 W
Mercury-vapour lamps:			
– Uncorrected	1,000 W	1,000 W	1,000 W
– Parallel compensated	800 W	800 W	800 W
LED lamps/energy-saving lamps	250 W	250 W	250 W
Rated motor power	1,380 W	1,380 W	1,380 W
Max. peak inrush-current I_p (150 μs)	200 A	200 A	200 A
Max. peak inrush-current I_p (250 μs)	160 A	160 A	160 A
Max. peak inrush-current I_p (600 μs)	100 A	100 A	100 A
Number of ballasts (T5/T8, single element):²⁾			
18 W (ABB ballasts 1 x 18 SF)	10 ballasts	10 ballasts	10 ballasts
24 W (ABB ballasts 1 x 24 CY)	10 ballasts	10 ballasts	10 ballasts
36 W (ABB ballasts 1 x 36 CF)	7 ballasts	7 ballasts	7 ballasts
58 W (ABB ballasts 1 x 58 CF)	5 ballasts	5 ballasts	5 ballasts
80 W (Helvar EL 1 x 80 SC)	3 ballasts	3 ballasts	3 ballasts

1) = The number of ballasts is limited by the protection with B16/B20 circuit-breakers.

2) = For multiple element lamps or other types, the number of electronic ballasts must be determined using the peak inrush-current of the electronic ballasts.

3) = The maximum peak inrush-current may not be exceeded.

4) = Not intended for AC3 operation, see Technical Data for maximum AC3 current.

5) = Max. load current per device: 8-fold = 100 A, 16-fold = 160 A, 24-fold = 200 A

The following table provides an overview of the functions possible with the Switch Actuators and their application programs:

	SAH/S 8.6.7.1 SAH/S 16.6.7.1 SAH/S 24.6.7.1	SAH/S 8.10.7.1 SAH/S 16.10.7.1 SAH/S 24.10.7.1	SAH/S 8.16.7.1 SAH/S 16.16.7.1 SAH/S 24.16.7.1
Range	Combi	Combi	Combi
Type of installation	DIN-Rail	DIN-Rail	DIN-Rail
Number of outputs (Switch [Blind])	8 [4]/16 [8]/24 [12]	8 [4]/16 [8]/24 [12]	8 [4]/16 [8]/24 [12]
Module width (space unit)	4/8/12	4/8/12	4/8/12
Manual operation	■	■	■
Switching position indication	■	■	■
I _n rated current (A)	6 A	10 A	16 A
Current measurement	-	-	-
Switch function			
- Central On/Off	■	■	■
- Staircase lighting	■	■	■
- Staircase lighting advance warning	■	■	■
- Change staircase lighting time via group object	■	■	■
- Flashing	■	■	■
- Selection of N.O./N.C. contact	■	■	■
- Switching on/off delay	■	■	■
Energy Function	-	-	-
Load control integration	■	■	■
Priority objects/forced operation/blocking	■	■	■
Function Scene	■	■	■
Blind/shutter function			
- Central up/down/position/stop	■	■	■
- Blind/shutter control	■	■	■
- Wind/Rain/Frost alarm	■	■	■
- Automatic sun protection	■	■	■
- Parameterizable reversing time	■	■	■
- Reference movement	■	■	■
- Travel range limitation	■	■	■
- Adjustable delay time for drives	■	■	■
Function Logic (independent of output)			
- Logic AND function	■	■	■
- Logic OR function	■	■	■
- Logic exclusive OR function	■	■	■
- Gate function	■	■	■
- 1 bit Inverter	■	■	■
Function Threshold (independent of output)	■	■	■
Additional functions			
- Request status values	■	■	■
- Template parameter windows	■	■	■
- Reaction on bus voltage failure/recovery	■	■	■
- Advanced status group objects	■	■	■

■ = Function is supported

- = Function is not supported

ABB i-bus® KNX

Outputs – Standard Switch Actuators

The following table provides an overview of the rated values, switching performance, lamp loads or the number of lamps, which can be connected to a contact:

	SA/S 2.6.2.2	SA/S 2.10.2.2	SA/S 2.16.2.2
	SA/S 4.6.2.2	SA/S 4.10.2.2	SA/S 4.16.2.2
	SA/S 8.6.2.2	SA/S 8.10.2.2	SA/S 8.16.2.2
	SA/S 12.6.2.2	SA/S 12.10.2.2	SA/S 12.16.2.2
Range	Standard	Standard	Standard
I_n rated current (A) ³⁾	6 A	10 A	16 A
U_n rated voltage (V)	230 V AC	230 V AC	230 V AC
AC1 operation (cos φ = 0.8) acc. to EN 60947-4-1	6 A	10 A	16 A
AC3 operation (cos φ = 0.45) acc. to EN 60947-4-1	6 A	8 A	8 A
C-Load switching capacity (200 μF)	–	–	–
Fluorescent lighting load AX acc. to EN 60669-1	6 AX (140 μF) ³⁾	10 AX (140 μF) ³⁾	16 A (140 μF) ³⁾
Minimum switching capacity	100 mA/12 V	100 mA/12 V	100 mA/12 V
DC current switching capacity (resistive load)	6 A/24 V =	10 A/24 V =	16 A/24 V =
Mechanical service life	> 3 x 10 ⁶	> 3 x 10 ⁶	> 3 x 10 ⁶
Electronic endurance acc. to IEC 60947-4-1:			
– Rated current AC1 (240 V/cos φ = 0.8)	100,000	100,000	100,000
– Rated current AC3 (240 V/cos φ = 0.45)	30,000	30,000	30,000
– Rated current AC5a (240 V/cos φ = 0.45)	30,000	30,000	30,000
Incandescent lamp load at 230 V AC	1,380 W	2,300 W	2,500 W
Fluorescent lamp T5 / T8:			
– Uncorrected	1,380 W	2,300 W	2,500 W
– Parallel compensated	1,380 W	1,500 W	1,500 W
– DUO circuit	1,380 W	1,500 W	1,500 W
Low-voltage halogen lamps:			
– Inductive transformer	1,200 W	1,200 W	1,200 W
– Electronic transformer	1,380 W	1,500 W	1,500 W
Halogen lamp 230 V	1,380 W	2,300 W	2,500 W
Dulux lamps:			
– Uncorrected	1,100 W	1,100 W	1,100 W
– Parallel compensated	1,100 W	1,100 W	1,100 W
Mercury-vapour lamps:			
– Uncorrected	1,380 W	2,000 W	2,000 W
– Parallel compensated	1,380 W	2,000 W	2,000 W
LED lamps/energy-saving lamps	400 W	400 W	400 W
Rated motor power	1,380 W	1,840 W	1,840 W
Max. peak inrush current I_p (150 μs)	400 A	400 A	400 A
Max. peak inrush current I_p (250 μs)	320 A	320 A	320 A
Max. peak inrush current I_p (600 μs)	200 A	200 A	200 A
Number of ballasts (T5/T8, single element):²⁾			
18 W (ABB ballasts 1 x 18 SF)	23 ballasts	23 ballasts	23 ballasts
24 W (ABB ballasts 1 x 24 CY)	23 ballasts	23 ballasts	23 ballasts
36 W (ABB ballasts 1 x 36 CF)	14 ballasts	14 ballasts	14 ballasts
58 W (ABB ballasts 1 x 58 CF)	11 ballasts	11 ballasts	11 ballasts
80 W (Helvar EL 1 x 80 SC)	10 ballasts	10 ballasts	10 ballasts

1) = The number of ballasts is limited by the protection with B16/B20 circuit-breakers.

2) = For multiple element lamps or other types, the number of electronic ballasts must be determined using the peak inrush-current of the electronic ballasts.

3) = The maximum peak inrush-current may not be exceeded.

4) = Not intended for AC3 operation, see Technical Data for maximum AC3 current.

The following table provides an overview of the functions possible with the Switch Actuators and their application programs:

	SA/S 2.6.2.2	SA/S 2.10.2.2	SA/S 2.16.2.2
	SA/S 4.6.2.2	SA/S 4.10.2.2	SA/S 4.16.2.2
	SA/S 8.6.2.2	SA/S 8.10.2.2	SA/S 8.16.2.2
	SA/S 12.6.2.2	SA/S 12.10.2.2	SA/S 12.16.2.2
Range	Standard	Standard	Standard
Type of installation	DIN-Rail	DIN-Rail	DIN-Rail
Number of outputs	2/4/8/12	2/4/8/12	2/4/8/12
Module width (space unit)	2/4/8/12	2/4/8/12	2/4/8/12
Manual operation	■	■	■
Switching position indication	■	■	■
I _n rated current (A)	6 A	10 A	16 A
Current measurement	-	-	-
Switch function			
- Central On/Off	■	■	■
- Staircase lighting	■	■	■
- Staircase lighting advance warning	■	■	■
- Change staircase lighting time via group object	■	■	■
- Flashing	■	■	■
- Selection of N.O./N.C. contact	■	■	■
- Switching on/off delay	■	■	■
Energy Function	-	-	-
Load control integration	■	■	■
Priority objects/forced operation/blocking	■	■	■
Function Scene	■	■	■
Blind/shutter function	-	-	-
Function Logic (independent of output)			
- Logic AND function	■	■	■
- Logic OR function	■	■	■
- Logic exclusive OR function	■	■	■
- Gate function	■	■	■
- 1 bit Inverter	■	■	■
Function Threshold (independent of output)	■	■	■
Additional functions			
- Request status values	■	■	■
- Template parameter windows	■	■	■
- Reaction on bus voltage failure/recovery	■	■	■
- Advanced status group objects	■	■	■

—
 ■ = Function is supported
 - = Function is not supported

ABB i-bus® KNX

Outputs – Professional Switch Actuators

The following table provides an overview of the rated values, switching performance, lamp loads or the number of lamps, which can be connected to a contact:

	SA/S 2.16.5.2	SA/S 2.16.6.2
	SA/S 4.16.5.2	SA/S 4.16.6.2
	SA/S 8.16.5.2	SA/S 8.16.6.2
	SA/S 12.16.5.2	SA/S 12.16.6.2
Range	Professional	Professional with Energy Function
I_n rated current (A) ³⁾	16/20 A C-Load	16/20 A C-Load
U_n rated voltage (V)	230 V AC	230 V AC
AC1 operation (cos φ = 0.8) acc. to EN 60947-4-1	20 A	20 A
AC3 operation (cos φ = 0.45) acc. to EN 60947-4-1	16 A	16 A
C-Load switching capacity (200 μF)	20 A	20 A
Fluorescent lighting load AX acc. to EN 60669-1	20 AX (200 μF) ³⁾	20 AX (200 μF) ³⁾
Minimum switching capacity	100 mA/12 V	100 mA/12 V
DC current switching capacity (resistive load)	20 A/24 V =	20 A/24 V =
Mechanical service life	> 10 ⁶	> 10 ⁶
Electronic endurance acc. to IEC 60947-4-1:		
– Rated current AC1 (240 V/cos φ = 0.8)	100,000	100,000
– Rated current AC3 (240 V/cos φ = 0.45)	30,000	30,000
– Rated current AC5a (240 V/cos φ = 0.45)	30,000	30,000
Incandescent lamp load at 230 V AC	3,680 W	3,680 W
Fluorescent lamp T5 / T8:		
– Uncorrected	3,680 W	3,680 W
– Parallel compensated	2,500 W	2,500 W
– DUO circuit	3,680 W	3,680 W
Low-voltage halogen lamps:		
– Inductive transformer	2,000 W	2,000 W
– Electronic transformer	2,500 W	2,500 W
Halogen lamp 230 V	3,680 W	3,680 W
Dulux lamps:		
– Uncorrected	3,680 W	3,680 W
– Parallel compensated	3,000 W	3,000 W
Mercury-vapour lamps:		
– Uncorrected	3,680 W	3,680 W
– Parallel compensated	3,000 W	3,000 W
LED lamps/energy-saving lamps	650 W	650 W
Rated motor power	3,680 W	3,680 W
Max. peak inrush current I_p (150 μs)	600 A	600 A
Max. peak inrush current I_p (250 μs)	480 A	480 A
Max. peak inrush current I_p (600 μs)	300 A	300 A
Number of ballasts (T5/T8, single element):²⁾		
18 W (ABB ballasts 1 x 18 SF)	26 ¹⁾ ballasts	26 ¹⁾ ballasts
24 W (ABB ballasts 1 x 24 CY)	26 ¹⁾ ballasts	26 ¹⁾ ballasts
36 W (ABB ballasts 1 x 36 CF)	22 ballasts	22 ballasts
58 W (ABB ballasts 1 x 58 CF)	12 ¹⁾ ballasts	12 ¹⁾ ballasts
80 W (Helvar EL 1 x 80 SC)	12 ¹⁾ ballasts	12 ¹⁾ ballasts

1) = The number of ballasts is limited by the protection with B16/B20 circuit-breakers.

2) = For multiple element lamps or other types, the number of electronic ballasts must be determined using the peak inrush-current of the electronic ballasts.

3) = The maximum peak inrush-current may not be exceeded.

4) = Not intended for AC3 operation, see Technical Data for maximum AC3 current.

The following table provides an overview of the functions possible with the Switch Actuators and their application programs:

	SA/S 2.16.5.2 SA/S 4.16.5.2 SA/S 8.16.5.2 SA/S 12.16.5.2	SA/S 2.16.6.2 SA/S 4.16.6.2 SA/S 8.16.6.2 SA/S 12.16.6.2
Range	Professional	Professional with Energy Function
Type of installation	DIN-Rail	DIN-Rail
Number of outputs	2/4/8/12	2/4/8/12
Module width (space unit)	2/4/8/12	2/4/8/12
Manual operation	■	■
Switching position indication	■	■
I _n rated current (A)	16/20 A C-Load	16/20 A C-Load
Current measurement	-	■
Switch function		
- Central On/Off	■	■
- Staircase lighting	■	■
- Staircase lighting advance warning	■	■
- Change staircase lighting time via group object	■	■
- Flashing	■	■
- Selection of N.O./N.C. contact	■	■
- Switching on/off delay	■	■
Energy Function	-	■
- Current measurement	-	■
- Power calculation	-	■
- Energy consumption calculation	-	■
- Load monitoring	-	■
Load control integration	■	■
Priority objects/forced operation/blocking	■	■
Function Scene	■	■
Blind/shutter function	-	-
Function Logic (independent of output)		
- Logic AND function	■	■
- Logic OR function	■	■
- Logic exclusive OR function	■	■
- Gate function	■	■
- 1 bit Inverter	■	■
Function Threshold (independent of output)	■	■
Additional functions		
- Request status values	■	■
- Template parameter windows	■	■
- Reaction on bus voltage failure/recovery	■	■
- Advanced status group objects	■	■

- ■ = Function is supported
 - = Function is not supported

ABB i-bus® KNX

Outputs – Combi Switch Actuators



SAH/S 8.6.7.1

Switch/Shutter Actuator, 6 A, MDRC

The compact 6 A combi switch actuator has 8, 16 or 24 independent switching relays. The outputs can be used individually via ABB i-bus® KNX for switching electrical loads or in pairs for controlling 230 V AC roller shutter or blind drives (no electromechanically interlocking). The device features a manual operation, which can also be disabled. Via the manual operation the outputs can be operated manually and the switching or driving status is displayed. The device is powered by KNX and requires no additional power supply. Devices support the ABB i-bus® Tool for advanced diagnostics and improved commissioning.

Description	Mod. width	Order details		Price	Weight	Pack
		Type code	Order code	1 piece	1 piece	unit
					kg	pc.
8-fold	4	SAH/S 8.6.7.1	2CDG110244R0011		0.35	1
16-fold	8	SAH/S 16.6.7.1	2CDG110245R0011		0.60	1
24-fold	12	SAH/S 24.6.7.1	2CDG110246R0011		0.83	1



SAH/S 16.10.7.1

Switch/Shutter Actuator, 10 A, MDRC

The compact 10 A combi switch actuator has 8, 16 or 24 independent switching relays. The outputs can be used individually via ABB i-bus® KNX for switching electrical loads or in pairs for controlling 230 V AC roller shutter or blind drives (no electromechanically interlocking). The device features a manual operation, which can also be disabled. Via the manual operation the outputs can be operated manually and the switching or driving status is displayed. The device is powered by KNX and requires no additional power supply. Devices support the ABB i-bus® Tool for advanced diagnostics and improved commissioning.

Description	Mod. width	Order details		Price	Weight	Pack
		Type code	Order code	1 piece	1 piece	unit
					kg	pc.
8-fold	4	SAH/S 8.10.7.1	2CDG110247R0011		0.35	1
16-fold	8	SAH/S 16.10.7.1	2CDG110248R0011		0.60	1
24-fold	12	SAH/S 24.10.7.1	2CDG110249R0011		0.83	1



SAH/S 24.16.7.1

Switch/Shutter Actuator, 16 A, MDRC

The compact 16 A combi switch actuator has 8, 16 or 24 independent switching relays. The outputs can be used individually via ABB i-bus® KNX for switching electrical loads or in pairs for controlling 230 V AC roller shutter or blind drives (no electromechanically interlocking). The device features a manual operation, which can also be disabled. Via the manual operation the outputs can be operated manually and the switching or driving status is displayed. The device is powered by KNX and requires no additional power supply. Devices support the ABB i-bus® Tool for advanced diagnostics and improved commissioning.

Description	Mod. width	Order details		Price	Weight	Pack
		Type code	Order code	1 piece	1 piece	unit
					kg	pc.
8-fold	4	SAH/S 8.16.7.1	2CDG110250R0011		0.35	1
16-fold	8	SAH/S 16.16.7.1	2CDG110251R0011		0.60	1
24-fold	12	SAH/S 24.16.7.1	2CDG110252R0011		0.83	1

ABB i-bus® KNX

Outputs – Standard Switch Actuators



SA/S 2.6.2.2

Switch Actuator, 6 A, MDRC

The switch actuator uses potential free contacts to switch 2, 4, 8 or 12 independent electrical loads via the ABB i-bus® KNX. The device features a manual operation and displaying of the switching state of the outputs. The 6 A device is especially suited to switch resistive, inductive or capacitive loads. The device is powered by KNX and requires no additional power supply. Devices support the ABB i-bus® Tool for advanced diagnostics and improved commissioning.

Description	Mod. width	Order details		Price	Weight	Pack
		Type code	Order code	1 piece	1 piece	unit
					kg	pc.
2-fold	2	SA/S 2.6.2.2	2CDG110253R0011		0.20	1
4-fold	4	SA/S 4.6.2.2	2CDG110254R0011		0.29	1
8-fold	8	SA/S 8.6.2.2	2CDG110255R0011		0.5	1
12-fold	12	SA/S 12.6.2.2	2CDG110256R0011		0.72	1



SA/S 8.10.2.2

Switch Actuator, 10 A, MDRC

The switch actuator uses potential free contacts to switch 2, 4, 8 or 12 independent electrical loads via the ABB i-bus® KNX. The device features a manual operation and displaying of the switching state of the outputs. The 10 A device is especially suited for loads with high surge currents e.g. fluorescent lighting (AX) acc. EN 60669. The device is powered by KNX and requires no additional power supply. Devices support the ABB i-bus® Tool for advanced diagnostics and improved commissioning.

Description	Mod. width	Order details		Price	Weight	Pack
		Type code	Order code	1 piece	1 piece	unit
					kg	pc.
2-fold	2	SA/S 2.10.2.2	2CDG110257R0011		0.20	1
4-fold	4	SA/S 4.10.2.2	2CDG110258R0011		0.29	1
8-fold	8	SA/S 8.10.2.2	2CDG110259R0011		0.5	1
12-fold	12	SA/S 12.10.2.2	2CDG110260R0011		0.72	1



SA/S 12.16.2.2

Switch Actuator, 16 A, MDRC

The switch actuator uses potential free contacts to switch 2, 4, 8 or 12 independent electrical loads via the ABB i-bus® KNX. The device features a manual operation and displaying of the switching state of the outputs. Devices support the ABB i-bus® Tool for advanced diagnostics and improved commissioning.

Description	Mod. width	Order details		Price	Weight	Pack
		Type code	Order code	1 piece	1 piece	unit
					kg	pc.
2-fold	2	SA/S 2.16.2.2	2CDG110261R0011		0.20	1
4-fold	4	SA/S 4.16.2.2	2CDG110262R0011		0.29	1
8-fold	8	SA/S 8.16.2.2	2CDG110263R0011		0.5	1
12-fold	12	SA/S 12.16.2.2	2CDG110264R0011		0.72	1

ABB i-bus® KNX

Outputs – Professional Switch Actuators



SA/S 4.16.5.2

Switch Actuator, 16 A, C-Load, MDRC

The switch actuator uses potential free contacts to switch 2, 4, 8 or 12 independent electrical loads via the ABB i-bus® KNX. The device features a manual operation and displaying of the switching state of the outputs. The 16/20 A, 16 A-AC3 (C-load) device is especially suited for loads with high surge currents e.g. fluorescent lighting (AX) acc. EN 60669. Devices support the ABB i-bus® Tool for advanced diagnostics and improved commissioning.

Description	Mod. width	Order details		Price	Weight	Pack unit
		Type code	Order code	1 piece	1 piece	
				€	kg	pc.
2-fold	2	SA/S 2.16.5.2	2CDG110265R0011		0.21	1
4-fold	4	SA/S 4.16.5.2	2CDG110266R0011		0.31	1
8-fold	8	SA/S 8.16.5.2	2CDG110267R0011		0.55	1
12-fold	12	SA/S 12.16.5.2	2CDG110268R0011		0.79	1

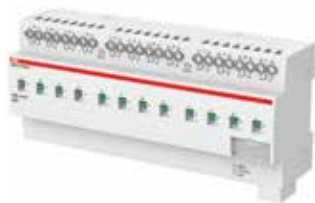

SA/S 12.16.6.2

Switch Actuator, 16 A, C-Load with Energy Function, MDRC

The switch actuator uses potential free contacts to switch 2, 4, 8 or 12 independent electrical loads via ABB i-bus® KNX. The device has integrated energy functions. This includes independent load current measurement in each output and easy to use calculation of power and energy consumption for each output or groups of outputs. Via an integrated load shedding object an integration in a load control system can be easily realized. The device features a manual operation and displaying of the switching state of the outputs. The 16/20 A, 16 A-AC3 (C-load) device is especially suited for loads with high surge currents e.g. LED or fluorescent lighting (AX) acc. EN60669. Devices support the ABB i-bus® Tool for advanced diagnostics and improved commissioning.

Description	Mod. width	Order details		Price	Weight	Pack unit
		Type code	Order code	1 piece	1 piece	
				€	kg	pc.
2-fold	2	SA/S 2.16.6.2	2CDG110269R0011		0.24	1
4-fold	4	SA/S 4.16.6.2	2CDG110270R0011		0.37	1
8-fold	8	SA/S 8.16.6.2	2CDG110271R0011		0.66	1
12-fold	12	SA/S 12.16.6.2	2CDG110272R0011		0.96	1

ABB i-bus® KNX

Outputs



SA/U 1.16.2

Switch Actuator, 1-fold, 16 A, FM

For switching 230 V~ consumers. Equipped with three extension inputs which depending on parameterization can act directly on the switching output or alternatively as binary inputs on the KNX bus. One Normally open contact, potential free; switching voltage: 230 V AC; 50 Hz; max. switching current: 16 A; switching capacity: up to 2.500 W depending on the consumer. Rated voltage: 230 V~, +10% / -10%, 50 Hz. The bus can be connected via enclosed terminal block.

Description	Mod. width	Order details		Price	Weight	Pack
		Type code	Order code	1 piece	1 piece	unit
				€	kg	pc.
	-	SA/U 1.16.2	2CKA006151A0280		0.11	1



SAH/U 2.16.2

Switch/Shutter Actuator, 2/1-fold, FM

For controlling blind or awning motors or for switching two 230 V~ consumers. With 3 inputs and 1 change-over output – normally open contact, potential-bound -. Rated voltage: 230 V~, +10% / -10%, 50 Hz. Input polling voltage: 5 V. Output rated current: 3 A, cos φ 0.8, Output voltage: 250 V~.

The bus can be connected via enclosed terminal block.

Description	Mod. width	Order details		Price	Weight	Pack
		Type code	Order code	1 piece	1 piece	unit
				€	kg	pc.
	-	SAH/U 2.16.2	2CKA006152A0042		0.11	1



IO/S 4.6.1.1

I/O Actuator, 6 A, MDRC

For the control of loads in residential areas, typically in hotel rooms and apartments. The I/O Actuators provide binary inputs for the connection of conventional push-buttons and outputs for switching loads. Inputs and outputs can be internally connected by ETS. By integrating the devices into KNX networks further functions can be realised: e.g. central control or room based emergency calls to a control centre.

Description	Mod. width	Order details		Price	Weight	Pack
		Type code	Order code	1 piece	1 piece	unit
				€	kg	pc.
4-fold	4	IO/S 4.6.1.1	2CDG110168R0011		0.17	1
8-fold	8	IO/S 8.6.1.1	2CDG110169R0011		0.30	1

ABB i-bus® KNX

Outputs



AA/S 4.1.2



AA/A 2.1.2

Analogue Actuator

The Analogue Actuator converts KNX telegrams in voltage (0...10 V) or current (0...24 mA) signals. These analogue output signals are used to influence regulatory processes. For example, devices for heating, air conditioning or ventilation applications can be adjusted in their operation depending on the information, which are transmitted via the bus system. This Analogue Actuator is available in a 4-fold DIN rail version and a 2-fold device with surface mounting housing. The ABB i-bus® Tool is supported for advanced diagnosis and improved commissioning.

Description	Mod. width	Order details		Price	Weight	Pack
		Type code	Order code	1 piece	1 piece	unit
				€	kg	pc.
4-fold, MDRC	4	AA/S 4.1.2	2CDG110202R0011		0.19	1
2-fold, SM	–	AA/A 2.1.2	2CDG110203R0011		0.30	1

ABB i-bus® KNX Shading Control

Modern building installation enables a high degree of functionality and simultaneously complies with increased security requirements. Due to the structured installation of the electrical components, it is possible to carry out rapid planning, installation and setup as well as achieve cost benefits during operation.

Modern sun protection devices have a significant role, as they must fulfil many demands:

- Anti-glare protection (e.g. PC workstations)
- Utilization of daylight by tracking the sun's position and directing available daylight
- Protecting furniture and carpets from fading
- Regulating the room temperature (overheating protection in summer; harvesting the available energy on cold days)
- Providing protection from people looking in from the outside
- Protection against intruders.

With the Blind/Roller Shutter Actuators JRA/S, the complex requirements on a sustainable and energy efficient automatic sun protection control can be implemented in offices, residential and functional buildings via ABB i-bus® KNX.

The Blind/Roller Shutter Actuators are ideal for the control of drives in the area of sun protection:

- Blinds, exterior blinds, slat blinds and panel curtains
- Roller shutters, roller blinds, screens, vertical blinds
- Awnings, pleated blinds, pleated curtains, etc.

Optimum room air quality via automatic ventilation

The demands for the reduction of energy consumption often results in poor ventilation in today's heavily insulated buildings. The quality of the room air does not comply with the desired and required level.

Natural ventilation is often an effective and efficient method for exchanging the "used" room air and improving the air quality in the room. If the air quality in the room is monitored with sensors (temperature, humidity, CO₂ concentration), the ventilation flaps can be opened automatically and in good time ensuring that the air quality is kept in a comfortable range.

Blind/Roller Shutter Actuators are ideal for control of ventilation elements such as

- Ventilation flaps
- Roof hatches, skylights
- Windows, doors and gates



ABB i-bus® KNX Shading Control



Automatic travel detection

Travel times for the connected drives can be easily determined during operation with the automatic travel detection feature. It saves time during setup. Furthermore, compensation of age and weather-related length changes to blinds or roller shutters is assured. It facilitates precise positioning of the blinds/shutter when using sun position-dependent control.

Diagnostics

Enhanced diagnostic messages can be issued with the Blind/Roller Shutter Actuators. They are particularly useful during setup or in the event of faults. It is possible, for example, to detect and signal if the power supply to a drive is interrupted.

Copy and exchange

This function allows parameter settings of an output to be copied or exchanged with other freely selectable outputs.

This is possible within a device or in conjunction with several devices. Copy and exchange is useful particularly on projects, where all drives of a facade are controlled identically.

It shortens the setup process and reduces the possible sources of error with parameterization.

Integration in the room temperature control

The intelligent and networked blind and roller shutter control plays an important role in the energy efficient usage of a building. The level of sunlight in the room and heating up due to the sun's energy can be controlled in conjunction with the room climate control. The software function "overheat control" prevents unintentional overheating of a room. The blinds are closed in good time. The shutter control can be actively involved in the room temperature control – a requirement for implementing high-efficient buildings compliant to EN 15232.

	Standard					SMI	
	JRA/S X.230.5.1	JRA/S 4.24.5.1	JRA/S X.230.2.1	JRA/S X.230.1.1	JRA/S 6.230.3.1	SJR/S 4.24.2.1	JA/S 4.SMI.1M
General							
Supply voltage	KNX	KNX	KNX	KNX	KNX	KNX	KNX
Nominal voltage	230 V AC	24 V DC	230 V AC	230 V AC	230 V AC	24 V DC	230 V AC
Auxiliary voltage	-	-	-	-	-	230 V AC	230 V AC
Type of installation	DIN-Rail					DIN-Rail	
Module width (space unit)	4/4/8	4	4/4/8	4/4/8	12	4	4
Number of outputs	X = 2, 4, 8	4	X = 2, 4, 8	X = 2, 4, 8	6	4 x 4 SMI LoVo (broadcast)	4 x 4 SMI (broadcast)
Manual operation	■	■	■	-	-	■	■
Inputs							
Internal connection between Inputs and Outputs	-	-	-	-	■	-	-
Blind/shutter control; dimming and switching control; value sending	-	-	-	-	■	-	-
Manual functions							
Disable/enable manual operation	■	■	■	-	-	■	■
Status manual operation	■	■	■	-	-	■	■
Operating modes							
Control with slat adjustment (blinds, etc.)	■	■	■	■	■	■	■
Control without slat adjustment (shutters, awnings, etc.)	■	■	■	■	■	■	■
Ventilation flaps, switch mode	■	■	■	■	■	-	-
Direct mode							
Limit UP/DOWN/STOP	■	■	■	■	-	■	■
Slat adjustment	■	■	■	■	■	■	■
Position height/slat [0...255]	■	■	■	■	■	■	■
Preset Move to position/Set position	■	■	■	■	-	■	■
Limited UP/DOWN	■	■	■	■	-	■	■
Enable limitation	■	■	■	■	-	■	■
Trigger travel detection	■	■	-	-	-	-	-
Trigger reference movement	■	■	■	■	■	-	-
8-bit scene	■	■	■	■	■	■	■

■ = Function is supported

- = Function is not supported

ABB i-bus® KNX

Shading Control

	Standard					SMI	
	JRA/S X.230.5.1	JRA/S 4.24.5.1	JRA/S X.230.2.1	JRA/S X.230.1.1	JRA/S 6.230.3.1	SJR/S 4.24.2.1	JA/S 4.SMI.1M
Safety							
Wind/Rain/Frost alarm	■	■	■	■	■	■	■
Disable control	■	■	■	■	-	■	■
Forced operation (1-bit and 2-bit)	■	■	■	■	-	■	■
Reaction after bus voltage failure/recovery, programming	■	■	■	■	■	■	■
Automatic mode							
Activation of automatic control	■	■	■	■	■	■	■
Position height/ slat position if sunny	■	■	■	■	■	■	■
Presence	■	■	■	■	-	■	■
Heating/Cooling	■	■	■	■	-	■	■
Overheat control	■	■	■	■	-	-	-
Enable/disable automatic control	■	■	■	■	■	■	■
Enable/disable direct operation	■	■	■	■	■	■	■
Status messages							
Height/slat [0...255]	■	■	■	■	■	■	■
Upper/lower end position	■	■	■	■	■	■	■
Operability	■	■	■	■	■	■	■
Automatic	■	■	■	■	■	■	■
Status byte (2-byte)	■	■	■	■	■	-	-
SMI	-	-	-	-	-	■	■
Positions/limit position	-	-	-	-	-	■	■
Auxiliary voltage	-	-	-	-	-	■	■
SMI Diagnostic byte	-	-	-	-	-	■	■
Various							
Automatic travel detection	■	■	-	-	-	-	-
Time-delayed switching of drives	■	■	■	■	-	■	■
Limit rate of telegrams	■	■	■	■	■	-	-
Transmission and switching delay	■	■	■	■	-	-	-
In operation function	■	■	■	■	■	-	-
Request status values	■	■	■	■	■	-	-
Extended setting options for drives and blinds/shutters	■	■	■	■	■	■	■
Total turning of slats after move down command	■	■	■	■	-	-	-
Position of slat after arriving on lower end position	■	■	■	■	■	■	■
Commissioning and diagnostic function							
Control and diagnosis via ABB i-bus® Tool	■	■	■	■	-	-	-
Binary Outputs							
Relay output 6 A (number of outputs)	x = 2, 4, 8	4	x = 2, 4, 8	x = 2, 4, 8	6	-	-
Forced operation	■	■	■	■	■	-	-
Time function							
Staircase lighting, flashing, On/Off delay	-	-	-	-	■	-	-
Logic	-	-	-	-	■	-	-
Scene	-	-	-	-	■	-	-

■ = Function is supported

- = Function is not supported



JRA/S 8.230.5.1

Blind/Roller Shutter Actuator with Travel Detection, 230 V AC, Manual Operation, MDRC

For the control of independent 230 V AC drives via ABB i-bus® KNX. The devices are designed for positioning blinds, roller shutters, awnings and other shading products as well as for controlling doors, windows and ventilation flaps. Additional auxiliary voltage is not needed. The travel times of the drive are detected automatically via current detection. To protect the drives, the output contacts are electromechanically locked against each other. Push buttons are located at the front of the device to control the outputs e.g. during commissioning. The current status of the output is displayed via LEDs.

Description	Mod. width	Order details		Price	Weight	Pack unit
		Type code	Order code	1 piece	1 piece	
				€	kg	pc.
2-fold	4	JRA/S 2.230.5.1	2CDG110124R0011		0.21	1
4-fold	4	JRA/S 4.230.5.1	2CDG110125R0011		0.25	1
8-fold	8	JRA/S 8.230.5.1	2CDG110126R0011		0.46	1



JRA/S 4.24.5.1

Blind/Roller Shutter Actuator with Travel Detection, 4-fold, 24 V AC, Manual Operation, MDRC

For the control of up to 4 independent 24 V DC drives via ABB i-bus® KNX. The device is designed for positioning blinds, roller shutters, awnings and other shading products as well as for controlling doors, windows and ventilation flaps. Additional auxiliary voltage is not needed. The travel times of the drive are detected automatically via current detection. Push buttons are located at the front of the device to control the outputs e.g. during commissioning. The current status of the output is displayed via LEDs.

Description	Mod. width	Order details		Price	Weight	Pack unit
		Type code	Order code	1 piece	1 piece	
				€	kg	pc.
	4	JRA/S 4.24.5.1	2CDG110128R0011		0.21	1



JRA/S 2.230.2.1

Blind/Roller Shutter Actuator, 2-fold, 230 V AC, Manual Operation, MDRC

For the control of independent 230 V AC drives via ABB i-bus® KNX. The devices are designed for positioning blinds, roller shutters, awnings and other shading products as well as for controlling doors, windows and ventilation flaps. Additional auxiliary voltage is not needed. To protect the drives, the output contacts are electromechanically locked against each other. Push buttons are located at the front of the device to control the outputs e.g. during commissioning. The current status of the output is displayed via LEDs.

Description	Mod. width	Order details		Price	Weight	Pack unit
		Type code	Order code	1 piece	1 piece	
				€	kg	pc.
2-fold	4	JRA/S 2.230.2.1	2CDG110120R0011		0.21	1
4-fold	4	JRA/S 4.230.2.1	2CDG110121R0011		0.25	1
8-fold	8	JRA/S 8.230.2.1	2CDG110122R0011		0.46	1

ABB i-bus® KNX Shading Control



JRA/S 2.230.1.1

Blind/Roller Shutter Actuator, 230 V AC, MDRC

For the control of independent 230 V AC drives via ABB i-bus® KNX. The devices are designed for positioning blinds, roller shutters, awnings and other shading products as well as for controlling doors, windows and ventilation flaps. Additional auxiliary voltage is not needed. To protect the drives, the output contacts are electromechanically locked against each other.

Description	Mod. width	Order details		Price	Weight	Pack unit
		Type code	Order code	1 piece	1 piece	
				€	kg	pc.
2-fold	4	JRA/S 2.230.1.1	2CDG110129R0011		0.21	1
4-fold	4	JRA/S 4.230.1.1	2CDG110130R0011		0.25	1
8-fold	8	JRA/S 8.230.1.1	2CDG110131R0011		0.46	1



JRA/S 6.230.3.1

Blind/Roller Shutter Actuator with Binary Inputs, 6-fold, 230 V, MDRC

For the control of 6 independent Blind/ Roller drives or air dampers. Via the 12 binary input a direct operation of the outputs is possible with conventional switch sensors. The binary inputs may also be used for other operations (e.g. switching, dimming). To protect the drives, the output contacts are electromechanically locked against each other.

Description	Mod. width	Order details		Price	Weight	Pack unit
		Type code	Order code	1 piece	1 piece	
				€	kg	pc.
	12	JRA/S 6.230.3.1	2CDG110208R0011		0.55	1



6173/11 U-500

Combi Actuator, FM

For controlling blind or awning motors. For connecting thermoelectric actuating drives. With 3 inputs and 2 outputs. A first output (O1) allows the control of electrically-operated Venetian blinds, roller shutters, awnings, venting louvers or similar blinds for 230 V AC mains voltage. One additional electronic switching output (O2) allows silent control of electrothermal valve drives for heating or cooling systems. The bus can be connected via enclosed terminal block. Rated voltage: 230 V~, +10% / -10%, 50 Hz – 60 Hz. Input polling voltage 5V. O1: Rated current 3 A, cos φ 0.8; Output voltage: 250 V~. O2: Rated current: 25 mA, cos φ 1, Output voltage: 250 V~.

Description	Mod. width	Order details		Price	Weight	Pack unit
		Type code	Order code	1 piece	1 piece	
				€	kg	pc.
	–	6173/11 U-500	2CKA006151A0249		0.11	1



JA/S 4.SMI.1M

SMI Shutter Actuator, 4-fold, Manual Operation, MDRC

It controls four independent groups (broadcast) with up to four SMI (Standard Motor Interface) drives (230 V) for positioning blinds, roller shutters, awnings and other shading products. Status signals (motor fault, direction of movement) can also be sent from the SMI drive on the bus. Push buttons are located at the front of the device to control the outputs e.g. during commissioning. The current status of the output is displayed via LEDs.

Description	Mod. width	Order details		Price	Weight	Pack unit
		Type code	Order code	1 piece	1 piece	
				€	kg	pc.
	4	JA/S 4.SMI.1M	2CDG110028R0011		0.25	1



SJR/S 4.24.2.1

SMI Blind/Roller Shutter Actuator, LoVo, 4-fold, MDRC

It controls four independent groups (broadcast) with up to four SMI (Standard Motor Interface) LoVo drives for positioning blinds, roller shutters, awnings and other shading products. Status signals (motor fault, direction of movement) can also be sent from the SMI drive on the bus. Push buttons are located at the front of the device to control the outputs e.g. during commissioning. The current status of the output is displayed via LEDs.

Description	Mod. width	Order details		Price	Weight	Pack unit
		Type code	Order code	1 piece	1 piece	
				€	kg	pc.
	4	SJR/S 4.24.2.1	2CDG110143R0011		0.25	1



JSB/S 1.1

Shutter Control Unit, MDRC

Controls shutter and blind actuators according to the position of the sun. The shutter control unit contains the functions of anti-glare protection and daylight redirection for up to 4 facades. Automatic shading can be implemented for every building and climatic control can be supported by the comprehensive range of parameter settings in the ETS.

Description	Mod. width	Order details		Price	Weight	Pack unit
		Type code	Order code	1 piece	1 piece	
				€	kg	pc.
	2	JSB/S 1.1	GHQ6310084R0111		0.12	1

Lighting Control

ABB i-bus® KNX DALI Gateways

Impressive lighting atmosphere, thanks to the DALI Gateways DG/S 1.64.5.1 and DG/S 2.64.5.1



A DALI Gateway serves as the interface between the KNX installation in the building and the digital DALI lighting control system, and therefore unites the two most important building automation standards.

ABBs DALI Gateway Premium devices enable maximum functionality and flexibility in lighting design thanks to the tunable white and color control function.

ABB i-bus® KNX

Lighting Control – DALI

The ABB DALI Gateways are used to interface between DALI (Digital Addressable Lighting Interface) and KNX installations. Four Gateways are available:

The basic versions DG/S 1.64.1.1 DALI Gateway (1-fold) and DG/S 2.64.1.1 DALI Gateway (2-fold) and on the other hand the premium versions DG/S 1.64.5.1 DALI Gateway (1-fold) and DG/S 2.64.5.1 DALI Gateway (2-fold). All incorporate the DALI power supply.

Both, basic and premium Gateways are equipped with emergency lighting function, support the DALI standard EN 62386-202 that specifies DALI emergency lighting (self-contained).

The two DALI Gateways Premium are additionally equipped with tunable white and color control function and supports the DALI standard EN 62386-209.

DALI Gateways DG/S 1.64.x.1

Flexibility by controlling light individually per device or in groups



The DG/S 1.64.1.1 DALI Gateway Basic (1-fold) or DG/S 1.64.5.1 DALI Gateway Premium (1-fold) can install up to 64 DALI devices both via 16 flexible DALI (orange lined group) and KNX lighting groups (green dotted lined group), each with one or more DALI participants. Control and Monitoring via KNX. Control and status feedback can also be carried out via Broadcast. 16 independent Lighting scenes are available.

DALI Gateways DG/S 2.64.x.1

Maximum flexibility combined with highest amount of DALI participants and groups, to meet all customer needs



The DG/S 2.64.1.1 DALI Gateway Basic (2-fold) or DG/S 2.64.5.1 DALI Gateway Premium (2-fold) can install up to 2 x 64 DALI devices both via 2 x 16 flexible DALI (orange lined group) and KNX lighting groups (green dotted lined group), each with one or more DALI participants. Control and Monitoring via KNX. Control and status feedback can also be carried out via Broadcast. 2 x 16 independent Lighting scenes are available.



ABB i-bus® KNX

Lighting Control – DALI

DALI Light Controller DLR/S 8.16.1M
Energy through constant lighting control

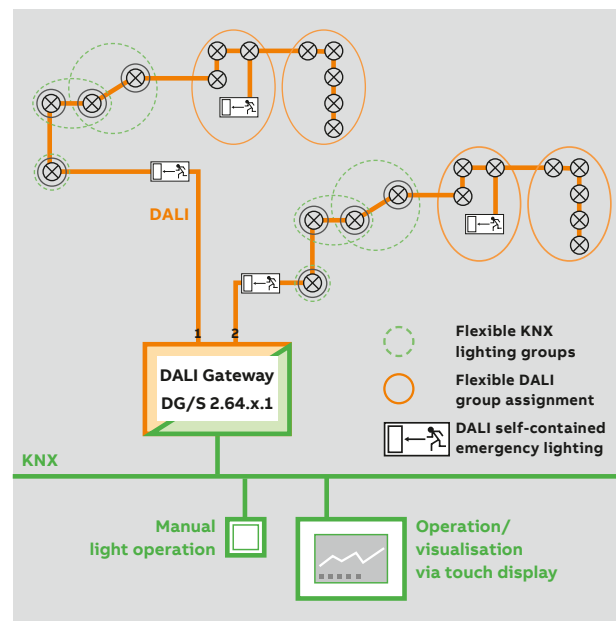
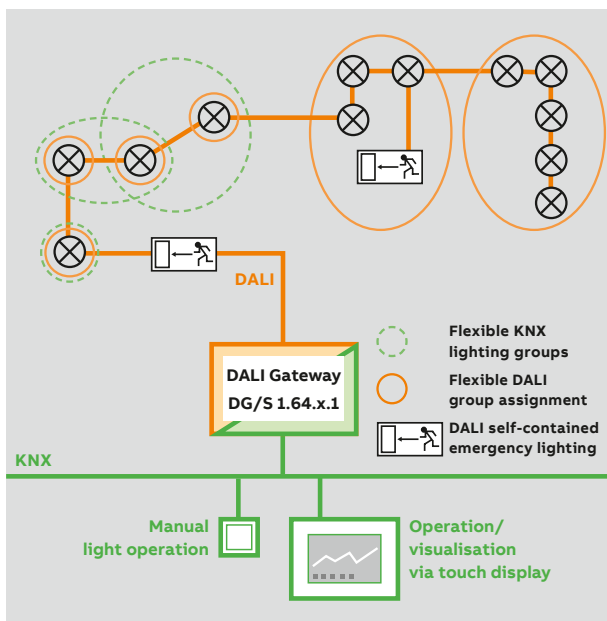

DALI Light Controller DLR/A 4.8.1.1
Decentralized Constant Lighting Control



Control via 16 lighting groups. Up to 8 lighting groups can be controlled with 8 light sensors. Master-slave, staircase light and Scene mode round off the functions.

The new DALI Light Controller DLR/A 4.8.1.1 is a surface mounting device for switching and dimming of 8 independent lighting groups. A maximum of 64 DALI devices can be connected. The device can be used for 4-fold constant lighting control in connection with 4 Light Sensors LF/U 2.1. Furthermore staircase lighting and master / slave functions are provided. Fault feedback messages, e.g. concerning ballast or lamp failures, can be programmed and activated via KNX. The compact surface-mounted housing allows the decentralized installation in the underfloor or in false ceilings – optimal for the use with Room Controller RC/A.

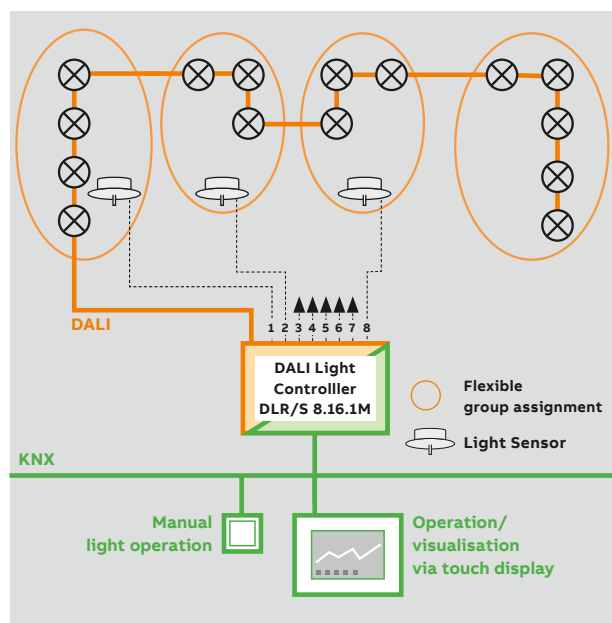

DALI Gateway DG/S 8.1 The proven technology



Lighting groups are formed via “rigid” hardware wiring.
Fast commissioning as no addressing is necessary.
No readdressing when a ballast is exchanged. 8 x 16 DALI devices.



ABB i-bus® KNX

Lighting Control – DALI

General	Gateways		
	DG/S 1.64.1.1	DG/S 2.64.1.1	DG/S 8.1
Supply voltage	100 – 240 V AC (85...265 V AC; 110...240 V DC)	100 – 240 V AC (85...265 V AC; 110...240 V DC)	100 – 240 V AC (85...265 V AC; 110...240 V DC)
Type of installation	DIN-Rail	DIN-Rail	DIN-Rail
Module width (space unit)	4	4	6
Number of outputs	1	2	8
Light sensor inputs	–	–	–
Degree of protection	IP20	IP20	IP20
Integrated power supply	■	■	■
Number of DALI participants	64	2 x 64	8 x 16
Broadcast control	■	■	■
Number of group control	16	2 x 16	–
Individual control	64	2 x 64	–
DT1 Self-contained emergency lighting, IEC 62 386-202	■	■	–
DT8 lighting (Tunable White, Tc, RGB(W)), IEC 62 386-209	–	–	–
Manual operation	■	■	■
Supports long-frames	■	■	–
DALI firmware update via KNX	■	■	–
Functions			
Enable/disable DALI address assignment	■	■	–
Switching, dimming, set brightness	■	■	■
Human Centric Lighting (HCL)	–	–	–
Dim2Warm	–	–	–
RGB(W)*	–	–	–
HSV(W)* - Hue, Saturation and Value*	–	–	–
Load control*	–	–	–
Sequencer*	–	–	–
Individual set/dimming colour temperature per group/ ballast	–	–	–
Tunable White Presets	–	–	–
Operating hours	–	–	–
Standby shutdown	–	–	–
Slave	■	■	■
Staircase lighting	■	■	■
Burn-in	■	■	■
Scenes, 8 bit call	■	■	■
Scenes, 1 bit call	–	–	■
Forced	■	■	–
Emergency lighting test	■	■	–
Partial failure	■	■	–
Constant light control	–	–	–
Reaction on KNX bus voltage failure	■	■	■
Reaction on KNX voltage recovery	■	■	■
Reaction on DALI bus voltage failure	■	■	■
Reaction on DALI voltage recovery	■	■	■
Power on level	■	■	–
Device or lamp fault	■	■	■
Cyclic monitoring telegram	■	■	■
DALI telegram rate modifiable	■	■	–
Commissioning and diagnostic functions (ABB i-bus® Tool)			
Device assignment	■	■	–
Group assignment	■	■	–
Fault DALI device	■	■	–
Fault lamp	■	■	–
Function test (ON/OFF/brightness value)	■	■	–
Commissioning constant light control	–	–	–
Test emergency lighting	■	■	–
Broadcast on/off	–	–	–
Shows if there are unaddressed DALI participants	–	–	–

■ = Function is supported

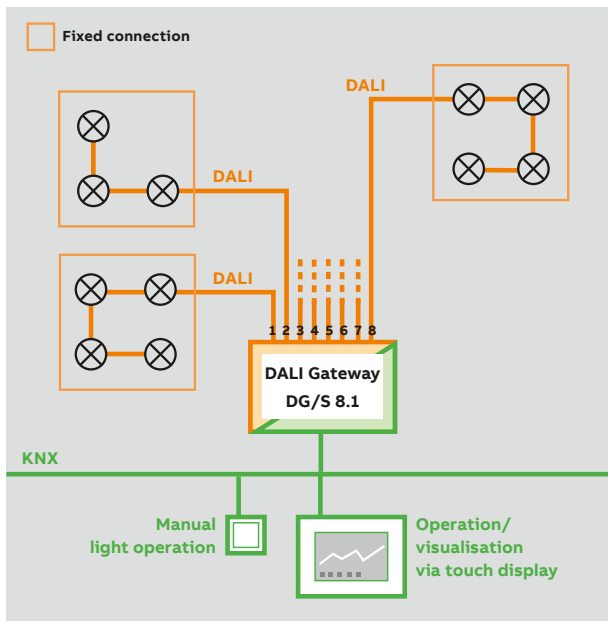
– = Function is not supported

* = From ETS application version 2.0

General	Gateways		Light Control	
	DG/S 1.64.5.1	DG/S 2.64.5.1	DLR/S 8.16.1M	DLR/A 4.8.1.1
Supply voltage	100 – 240 V AC (85...265 V AC; 110...240 V DC)	100 – 240 V AC (85...265 V AC; 110...240 V DC)	100 – 240 V AC (85...265 V AC; 110...240 V DC)	100 – 240 V AC (85...265 V AC; 110...240 V DC)
Type of installation	DIN-Rail	DIN-Rail	DIN-Rail	SM
Module width (space unit)	4	4	6	220 x 147 x 50 mm
Number of outputs	1	2	1	1
Light sensor inputs	–	–	8	4
Degree of protection	IP20	IP20	IP20	IP54
Integrated power supply	■	■	■	■
Number of DALI participants	64	2 x 64	64	64
Broadcast control	■	■	■	■
Number of group control	16	2 x 16	16	8
Individual control	64	2 x 64	–	–
DT1 Self-contained emergency lighting, IEC 62 386-202	■	■	–	–
DT8 lighting (Tunable White, Tc, RGB(W)), IEC 62 386-209	■	■	–	–
Manual operation	■	■	■	■
Supports long-frames	■	■	–	–
DALI firmware update via KNX	■	■	–	–
Functions				
Enable/disable DALI address assignment	■	■	■	■
Switching, dimming, set brightness	■	■	■	■
Human Centric Lighting (HCL)	■	■	–	–
Dim2Warm	■	■	–	–
RGB(W)*	■	■	–	–
HSV(W)* - Hue, Saturation and Value*	■	■	–	–
Load control*	■	■	–	–
Sequencer*	■	■	–	–
Individual set/dimming colour temperature per group/ ballast	■	■	–	–
Tunable White Presets	■	■	–	–
Operating hours	■	■	–	–
Standby shutdown	■	■	–	–
Slave	■	■	■	■
Staircase lighting	■	■	■	■
Burn-in	■	■	■	■
Scenes, 8 bit call	■	■	■	■
Scenes, 1 bit call	■	■	■	■
Forced	■	■	■	■
Emergency lighting test	■	■	–	–
Partial failure	■	■	–	–
Constant light control	–	–	■	■
Reaction on KNX bus voltage failure	■	■	■	■
Reaction on KNX voltage recovery	■	■	■	■
Reaction on DALI bus voltage failure	■	■	■	■
Reaction on DALI voltage recovery	■	■	■	■
Power on level	■	■	■	■
Device or lamp fault	■	■	■	■
Cyclic monitoring telegram	■	■	■	■
DALI telegram rate modifiable	■	■	–	–
Commissioning and diagnostic functions (ABB i-bus® Tool)				
Device assignment	■	■	■	■
Group assignment	■	■	■	■
Fault DALI device	■	■	■	■
Fault lamp	■	■	■	■
Function test (ON/OFF/brightness value)	■	■	■	■
Commissioning constant light control	–	–	■	■
Test emergency lighting	■	■	–	–
Broadcast on/off	■	■	–	–
Shows if there are unaddressed DALI participants	■	■	–	–

■ = Function is supported

– = Function is not supported

* = From ETS application version 2.0

ABB i-bus® KNX

Lighting Control – DALI



DG/S 1.64.1.1

DALI Gateway, Basic, MDRC

The device is used to interface between DALI and KNX installations and incorporates the DALI power supply. One/Two DALI output(s) for up to 64/2x 64 DALI participants. Control and status feedback is carried out via KNX per DALI participants (64/2x 64), with lighting groups (16/2x 64), together in broadcast or per scenes (16/2x 16). Extensive fault and error messages are available. Self-contained emergency converter (64/2x 64) acc. EN 62386-202 will be supported. By means of KNX and emergency converter, different emergency tests (e.g. function and duration test) can be triggered.

Feedback is sent. Slave-, staircase-, force-, block- and scene- function are integrated.

DALI telegram rate can change. For diagnostic use and individual change of the DALI address or group assignment a separate software tool (ABB i-bus® Tool) is available.

Description	Mod. width	Order details		Price	Weight	Pack
		Type code	Order code	1 piece	1 piece	unit
				€	kg	pc.
1-fold	4	DG/S 1.64.1.1	2CDG110198R0011		0.18	1
2-fold	4	DG/S 2.64.1.1	2CDG110199R0011		0.19	1



DG/S 1.64.5.1

DALI Gateway, Premium, MDRC

For controlling DALI devices via the ABB i-bus® KNX. One/Two DALI output(s) for up to 64/2x 64 DALI participants. DALI power supply is integrated. Control and status feedback is carried out via KNX per DALI participants (64/2x 64), with lighting groups (16/2x 16), together in broadcast or per scenes (16/2x 16). DALI devices type DT1 (Self-contained emergency converter acc. EN 62386-202) and type DT8 (colour temperature Tc / tunable white, RGB(W) acc. EN 62386-209) will be supported. Extensive fault and error messages are available. By means of KNX and DT1 converter different emergency tests (e.g. function and duration test) can be triggered, test results are transferred back to KNX. With DT8 devices Dim2Warm, HCL, set and dim colour temperature are possible. Slave-, staircase-, force-, block- and scene-function are integrated. Feedback is sent. DALI telegram rate can change. Another function is the standby switch-off in combination with a KNX switch actuator (e.g. SA/S).

From the ETS application version 2.0 the color functions RGB(W) and HSV(W) can be used.

This allows the color of a lamp to be controlled, dimmed and set. In addition to scenes, 4 sequences per DALI output can be parameterized. It is also possible to integrate the DALI Gateways into a load control system. The DALI Gateways determine the operating hours.

All these features can be used for individual EVGs and DALI groups.

For diagnostic use and individual change of the DALI address or group assignment a separate software tool (ABB i-bus® Tool) is available.

Description	Mod. width	Order details		Price	Weight	Pack
		Type code	Order code	1 piece	1 piece	unit
					kg	pc.
1-fold	4	DG/S 1.64.5.1	2CDG110273R0011		0.18	1
2-fold	4	DG/S 2.64.5.1	2CDG110274R0011		0.19	1



DG/S 8.1

DALI Gateway, 8-fold, MDRC

For controlling up to 128 DALI devices. There are 8 separate, independent DALI outputs/channels available. Up to 16 DALI devices can be connected per channel. The DALI power supply is integrated in the gateway. The functions of switching, dimming, set values and fault indication for lamps and electronic ballasts are available for each output. It is possible to set the lamp burn-in time and 16 light scenes. Commissioning is simplified as no addressing or commissioning of the DALI devices is necessary.

Description	Mod. width	Order details		Price	Weight	Pack
		Type code	Order code	1 piece	1 piece	unit
				€	kg	pc.
	6	DG/S 8.1	2CDG110025R0011		0.31	1



DLR/S 8.16.1M

DALI Light Controller, 8-fold, Manual Operation, MDRC

For switching and dimming of 16 independent lighting groups. A maximum of 64 DALI devices can be connected. The device can be used for 8-fold constant lighting control in connection with eight Light Sensors LF/U 2.1. Fault feedback messages can be programmed and activated via KNX. With comfortable manual operation and status display.

Description	Mod. width	Order details		Price	Weight	Pack
		Type code	Order code	1 piece	1 piece	unit
				€	kg	pc.
	6	DLR/S 8.16.1M	2CDG110101R0011		0.26	1



DLR/A 4.8.1.1

DALI Light Controller, 4-fold, SM

Surface mounting device for switching and dimming of 8 independent groups of luminaires. Up to 64 DALI participants can be connected to one DALI control line. When combined with the light sensor LF/U 2.1 the device can be used as a 4-fold light controller for constant light control. Additionally a staircase and master/slave function is integrated.

A great number of status feedback e.g. lamp and ballast fault can be transferred from DALI to KNX. With this functions the DALI light controller is a key factor in every energy efficient building automation. With his surface mounting housing it is possible to insert the device central in false ceiling or underfloor installation.

Description	Mod. width	Order details		Price	Weight	Pack
		Type code	Order code	1 piece	1 piece	unit
				€	kg	pc.
	–	DLR/A 4.8.1.1	2CDG110172R0011		0.66	1

ABB i-bus® KNX

Lighting Control

	Universal Dim Actuators	
	UD/S x.210.2.1	UD/S x.315.2.1
General		
Supply voltage	110 – 230 V AC ± 10 %, 50/60 Hz	110 – 230 V AC ± 10 %, 50/60 Hz
Type of installation	DIN-Rail	DIN-Rail
Module width (space unit)	6/8	4/8/12
Number of outputs	4/6	2/4/6
Maximum load per channel	4 x 210 W (1 x 600 W)/ 6 x 210 W (1 x 800 W)	2 x 315 W (1 x 500 W) 4 x 315 W (2 x 500 W) 6 x 315 W (2 x 700 W or 3 x 500 W)
Incoming supply	4/6 phase inputs	2/4/6 phase inputs
Load types		
230 V incandescent lamps	■	■
230 V halogen lamps	■	■
Low-voltage halogen lamps with conventional transformers or electronic transformers	■	■
LED strips or 12/24 V lamps	–	–
LED Retrofit 230 V	■	–
Grouping of channels for load increase	■	■ ³⁾
Switching		
Brightness value when turned on	■	■
Dimming speed for switching on and off	■	■
Dimming		
Min. and max. dimming values	■	■
Switching on/off via rel. dimming	■	■
Further functions		
Forced operation	■	■
Dimming curve adjustment	■	■
Reaction on bus voltage failure	■	■
Behavior on bus voltage recovery	■	■
Status feedback	■	■
Blocking channel	■	■
Scenes	■	■
Phase angle control: automatic, leading or trailing edge	■	■
Additional logic functions	■	■
Staircase lighting	■	■

■ = Function is supported

– = Function is not supported

1) = Selected LED retrofit lamps are tested and approved. Restrictions have to be observed
Details see Busch-Dimmer® Tool (www.busch-jaeger.com)

2) = One channel uses 500 W

3) = See maximum load per channel

LED Dimmer with constant curve		
	6155/30-500 1-4-fold	6155/40-500 1-4-fold with power supply
General		
Supply voltage	12...24 V DC	230 V AC \pm 10%, 50/60 Hz
Type of installation	Wall (surface)	Wall (surface)
Module width (space unit)	–	–
Number of outputs	4	4
Maximum load per channel	1 x 10 A/ 4 x 2.5 A	1 x 4 A/ 4 x 1 A
Incoming supply	1 phase input	1 phase input
Load types		
230 V incandescent lamps	–	–
230 V halogen lamps	–	–
Low-voltage halogen lamps with conventional transformers or electronic transformers	–	–
LED strips or 12/24 V lamps	■	■
LED Retrofit 230 V	–	–
Grouping of channels for load increase	■	■
Switching		
Brightness value when turned on	■	■
Dimming speed for switching on and off	■	■
Dimming		
Min. and max. dimming values	■	■
Switching on/off via rel. dimming	■	■
Further functions		
Forced operation	–	–
Dimming curve adjustment	–	–
Reaction on bus voltage failure	–	–
Behavior on bus voltage recovery	■	■
Status feedback	■	■
Blocking channel	■	■
Scenes	■	■
Phase angle control: automatic, leading or trailing edge	–	–
Additional logic functions	–	–
Staircase lighting	–	–

– = Function is not supported
 ■ = Function is supported

ABB i-bus® KNX

Lighting Control

	Switch/Dim Actuators			Constant Light Control	
	SD/S 2.16.1	SD/S 4.16.1	SD/S 8.16.1	LR/S 2.16.1	LR/S 4.16.1
General					
Supply voltage	KNX	KNX	KNX	KNX	KNX
Type of installation	DIN-Rail	DIN-Rail	DIN-Rail	DIN-Rail	DIN-Rail
Module width (space unit)	4	6	8	4	6
Number of outputs 1-10 V (passive)	2	4	8	2	4
Manual operation	■	■	■	■	■
Maximum current per control output	100 mA	100 mA	100 mA	100 mA	100 mA
Maximum cable length at maximum load (100 mA)	70 m (cable cross-section 0.8 mm ²)	70 m (cable cross-section 0.8 mm ²)	70 m (cable cross-section 0.8 mm ²)	70 m (cable cross-section 0.8 mm ²)	70 m (cable cross-section 0.8 mm ²)
	100 m (cable cross-section 1.5 mm ²)	100 m (cable cross-section 1.5 mm ²)	100 m (cable cross-section 1.5 mm ²)	100 m (cable cross-section 1.5 mm ²)	100 m (cable cross-section 1.5 mm ²)
Light sensor (LF/U 2.1)	-	-	-	2	4
Maximum cable length per sensor (P-ACYM or J-Y(ST)Y cable (SELV), diameter 0.8 mm)	-	-	-	100 m	100 m
Power loss per device at max. load	2.6 W	5.2 W	10.4 W	2.6 W	5.2 W
Switching capacity					
Rated current I _n	16 A AC1	16 A AC1	16 A AC1	16 A AC1	16 A AC1
Rated voltage U _n	250/440 V AC	250/440 V AC	250/440 V AC	250/440 V AC	250/440 V AC
AC1 operation (cos φ = 0.8) DIN EN 60 947-4-1	16 A	16 A	16 A	16 A	16 A
AC3 operation (cos φ = 0.45) DIN EN 60 947-4-1	8 A/ 230 V	8 A/ 230 V	8 A/ 230 V	8 A/ 230 V	8 A/ 230 V
Fluorescent lighting load AX DIN EN 60 669-1	10 A (140 μF) ¹⁾	10 A (140 μF) ¹⁾	10 A (140 μF) ¹⁾	10 A (140 μF) ¹⁾	10 A (140 μF) ¹⁾
Minimum switching capacity	100 mA/12 V	100 mA/12 V	100 mA/12 V	100 mA/12 V	100 mA/12 V
DC current switching capacity (resistive load)	10 A/24 V DC	10 A/24 V DC	10 A/24 V DC	10 A/24 V DC	10 A/24 V DC
Mechanical service life	> 3 x 10 ⁶	> 3 x 10 ⁶	> 3 x 10 ⁶	> 3 x 10 ⁶	> 3 x 10 ⁶
Electronic endurance to DIN IEC 60 947-4-1					
Rated current AC1 (240 V/cos φ = 0.8)	100,000	100,000	100,000	100,000	100,000
Rated current AC3 (240 V/cos φ = 0.45)	30,000	30,000	30,000	30,000	30,000
Rated current AC5a (240 V/cos φ = 0.45)	30,000	30,000	30,000	30,000	30,000
Incandescent lamp load at 230 V AC	2,300 W	2,300 W	2,300 W	2,300 W	2,300 W
Fluorescent lamps T5/T8					
Uncorrected	2,300 W	2,300 W	2,300 W	2,300 W	2,300 W
Parallel compensated	1,500 W	1,500 W	1,500 W	1,500 W	1,500 W
DUO circuit	1,500 W	1,500 W	1,500 W	1,500 W	1,500 W
Low-voltage halogen lamps					
Inductive transformer	1,200 W	1,200 W	1,200 W	1,200 W	1,200 W
Electronic transformer	1,500 W	1,500 W	1,500 W	1,500 W	1,500 W
Halogen lamp 230 V	2,500 W	2,500 W	2,500 W	2,500 W	2,500 W
Dulux lamps					
Uncorrected	1,100 W	1,100 W	1,100 W	1,100 W	1,100 W
Parallel compensated	1,100 W	1,100 W	1,100 W	1,100 W	1,100 W
Mercury-vapour lamps					
Inductive transformer	2,000 W	2,000 W	2,000 W	2,000 W	2,000 W
Electronic transformer	2,000 W	2,000 W	2,000 W	2,000 W	2,000 W

■ = Function is supported

- = Function is not supported

1) = The maximum peak inrush current may not be exceeded

	Switch/Dim Actuators			Constant Light Control	
	SD/S 2.16.1	SD/S 4.16.1	SD/S 8.16.1	LR/S 2.16.1	LR/S 4.16.1
Sodium-vapour lamps					
Inductive transformer	2,000 W	2,000 W	2,000 W	2,000 W	2,000 W
Electronic transformer	2,000 W	2,000 W	2,000 W	2,000 W	2,000 W
Max. peak inrush-current I_p (150 μ s)	400 A	400 A	400 A	400 A	400 A
Max. peak inrush-current I_p (250 μ s)	320 A	320 A	320 A	320 A	320 A
Max. peak inrush-current I_p (600 μ s)	200 A	200 A	200 A	200 A	200 A
Number of ballasts (T5/T8, single element) e.g.¹⁾					
18 W (ABB EVG 1 x 18 SF)	23	23	23	23	23
24 W (ABB EVG 1 x 24 CY)	23	23	23	23	23
36 W (ABB EVG 1 x 36 CF)	14	14	14	14	14
58 W (ABB EVG 1 x 58 CF)	11	11	11	11	11
80 W (Helvar EL 1 x 80 SC)	10	10	10	10	10

	Switch/Dim Actuators			Constant Light Control	
	SD/S 2.16.1	SD/S 4.16.1	SD/S 8.16.1	LR/S 2.16.1	LR/S 4.16.1
Functions					
Brightness control	–	–	–	■	■
Brightness value	■	■	■	■	■
Dimming speed for transition brightness values	■	■	■	■	■
Min. and max. value limits	■	■	■	■	■
Set switching on and off via value	■	■	■	■	■
Presets	■	■	■	■	■
Scenes	■	■	■	■	■
Switch					
Brightness value when turned on	■	■	■	■	■
Dimming speed for switching on and off	■	■	■	■	■
Dimming					
Dimming speed can be changed via KNX	■	■	■	■	■
Min. and max. dimming values	■	■	■	■	■
Switching on/off via rel. dimming	■	■	■	■	■
Forced operation					
2-bit coded forced operation	■	■	■	■	■
Behaviour after voltage recovery	■	■	■	■	■
Block Activate output via 1-bit object	■	■	■	■	■
Special					
4-point characteristic adjustment	■	■	■	■	■
Preference with bus voltage failure	■	■	■	■	■
Status feedback	■	■	■	■	■
Additional					
Slave mode e.g. for integration in the constant lighting control	■	■	■	■	■
Staircase lighting	■	■	■	■	■
Prewarning via dimming and/or KNX object	■	■	■	■	■
Commissioning and diagnostic functions					
Control and diagnosis via ABB i-bus® Tool	–	–	–	■	■

■ = Function is supported

– = Function is not supported

1) = For multiple element lamps or other types, the number of electronic ballasts must be determined using the peak inrush current of the electronic ballasts

ABB i-bus® KNX Lighting Control



LR/S 4.16.1

Light Controller, 1-10 V, MDRC

The device enables the switching and dimming of 2 or 4 independent lighting circuits in conjunction with electronic ballasts. In combination with the Light Sensor LF/U 2.1, the device can be used for constant lighting control. 2 or 4 light sensors can be connected to the controller for precise detection of the lighting conditions.

Description	Mod. width	Order details		Price	Weight	Pack unit
		Type code	Order code	1 piece	1 piece	
				€	kg	pc.
2-fold	4	LR/S 2.16.1	2CDG110087R0011		0.25	1
4-fold	6	LR/S 4.16.1	2CDG110088R0011		0.40	1



LF/U 2.1

Light Sensor, FM

Used for implementing constant lighting control applications in conjunction with light controllers LR/S, LR/M, DLR/S 8.16.1M or DLR/A 4.8.1.1. The scope of delivery includes different optical rods, the connection terminals and the cover for discrete fitting in a room.

Description	Mod. width	Order details		Price	Weight	Pack unit
		Type code	Order code	1 piece	1 piece	
				€	kg	pc.
	-	LF/U 2.1	2CDG110089R0011		0.07	1



SD/S 8.16.1

Switch/Dim Actuator, 16 A, MDRC

Used for switching and dimming of 2, 4 or 8 independent groups of luminaires with electronic ballasts with 1 – 10 V control interfaces. On each channel the power supply of the ballasts is switched by a floating load relay (16 A – AC1). Every output can be operated manually and features display of the switching state. The device can assume a range of applications thanks to the programming options.

Description	Mod. width	Order details		Price	Weight	Pack unit
		Type code	Order code	1 piece	1 piece	
				€	kg	pc.
2-fold	4	SD/S 2.16.1	2CDG110079R0011		0.21	1
4-fold	6	SD/S 4.16.1	2CDG110080R0011		0.32	1
8-fold	8	SD/S 8.16.1	2CDG110081R0011		0.56	1



UD/S 4.210.2.1

LED Dimmer, 4-fold, 210 W/VA, MDRC

Multichannel universal dimming actuator optimized for dimming of retrofit LED lamps (LEDi). Also suitable for dimming of incandescent lamps, low-voltage halogen lamps with conventional or electronic transformers, 230 V incandescent halogen lamps and dimmable halogen energy-saving lamps. Automatic load detection (deactivatable). One separate N-terminal per channel. Channel bridging possible in order to increase the maximum load. Outputs can be switched in parallel as required. Minimum load: 2 W. Manual operation on the device is possible also without bus voltage or in unprogrammed state. One LED control button per channel (including status indication) for ON and OFF switching as well as for up and down dimming. Programming of the device is possible without connecting 230 V supply voltage. Comprehensive test and diagnostic functions via the i-bus® Tool. Fast parameterization in the ETS by means of copyable channel templates. With integrated bus coupler.

Rated power at 230 V ~:

- 230 V ~ incandescent and halogen lamps: 4 x 210 W/VA to 1 x 600 W/VA.
- Dimmable 230 V ~ LEDi: 4 x 210 W/VA to 1 x 600 W/VA in trailing edge mode, 4 x 80 W/VA to 1 x 200 W/VA in leading edge mode.
- Inductive L-transformers with LED/low-voltage halogen lamps: 4 x 210 W/VA to 1 x 600 W/VA.
- Electronic C-transformers with LED/low voltage halogen lamps: 4 x 210 W/VA to 1 x 600 W/VA.
- Electronic LC transformers with LED/low-voltage halogen lamps: 4 x 80 W/VA to 1 x 200 W/VA.

Recommendation: Always use bulbs of one type and manufacturer.

Description	Mod. width	Order details		Price	Weight	Pack
		Type code	Order code	1 piece	1 piece	unit
				€	kg	pc.
4-fold	6	UD/S 4.210.2.1	2CKA006197A0047		0.28	1



UD/S 6.210.2.1

LED Dimmer, 6-fold, 210 W/VA, MDRC

Multichannel universal dimming actuator optimized for dimming of retrofit LED lamps (LEDi). Also suitable for dimming of incandescent lamps, low-voltage halogen lamps with conventional or electronic transformers, 230 V incandescent halogen lamps and dimmable halogen energy-saving lamps. Automatic load detection (deactivatable). One separate N-terminal per channel. Channel bridging possible in order to increase the maximum load. Outputs can be switched in parallel as required. Minimum load: 2 W. Manual operation on the device is possible also without bus voltage or in unprogrammed state. One LED control button per channel (including status indication) for ON and OFF switching as well as for up and down dimming. Programming of the device is possible without connecting 230 V supply voltage. Comprehensive test and diagnostic functions via the i-bus® Tool. Fast parameterization in the ETS by means of copyable channel templates. With integrated bus coupler.

Rated power at 230 V ~:

- 230 V ~ incandescent and halogen lamps: 6 x 210 W/VA to 1 x 800 W/VA.
- Dimmable 230 V ~ LEDi: 6 x 210 W/VA to 1 x 800 W/VA in trailing edge mode, 6 x 80 W/VA to 1 x 240 W/VA in leading edge mode.
- Inductive L-transformers with LED/low-voltage halogen lamps: 6 x 210 W/VA to 1 x 800 W/VA.
- Electronic C-transformers with LED/low voltage halogen lamps: 6 x 210 W/VA to 1 x 800 W/VA.
- Electronic LC transformers with LED/low-voltage halogen lamps: 6 x 80 W/VA to 1 x 240 W/VA.

Recommendation: Always use bulbs of one type and manufacturer.

Description	Mod. width	Order details		Price	Weight	Pack
		Type code	Order code	1 piece	1 piece	unit
				€	kg	pc.
6-fold	8	UD/S 6.210.2.1	2CKA006197A0049		0.58	1

ABB i-bus® KNX Lighting Control



UD/S 2.315.2.1

LED Dimmer, 2-fold, 315 W/VA, MDRC

Multichannel universal dimming actuator optimized for dimming of retrofit LED lamps (LEDi). Also suitable for dimming of incandescent lamps, low-voltage halogen lamps with conventional or electronic transformers, 230 V incandescent halogen lamps and dimmable halogen energy-saving lamps. Automatic load detection (deactivatable). One separate N-terminal per channel. Channel bridging possible in order to increase the maximum load. Outputs can be switched in parallel in groups as required. Minimum load: 2 W. Manual operation on the device is possible also without bus voltage or in unprogrammed state. One LED control button per channel (including status indication) for ON and OFF switching as well as for up and down dimming. Programming of the device is possible without connecting 230 V supply voltage. Comprehensive test and diagnostic functions via the i-bus® Tool. Fast parameterization in the ETS by means of copyable channel templates. With integrated bus coupler.

Rated power at 230 V ~:

- 230 V ~ incandescent and halogen lamps: 2 x 315 W/VA to 1 x 500 W/VA.
 - Dimmable 230 V ~ LEDi: 2 x 315 W/VA to 1 x 500 W/VA in trailing edge mode,
 - 2 x 120 W/VA to 1 x 200 W/VA in leading edge mode.
 - Inductive L-transformers with LED/low-voltage halogen lamps: 2 x 315 W/VA to 1 x 500 W/VA.
 - Electronic C-transformers with LED/low voltage halogen lamps: 2 x 315 W/VA to 1 x 500 W/VA.
 - Electronic LC transformers with LED/low-voltage halogen lamps: 2 x 120 W/VA to 1 x 200 W/VA.
- Recommendation: Always use bulbs of one type and manufacturer.

Description	Mod. width	Order details		Price	Weight	Pack
		Type code	Order code	1 piece	1 piece	unit
	4	UD/S 2.315.2.1	2CKA006197A0053	€	kg	pc.
				0.29		1



UD/S 4.315.2.1

LED Dimmer, 4-fold, 315 W/VA, MDRC

Multichannel universal dimming actuator optimised for dimming retrofit LED lamps (LEDi). Also suitable for dimming incandescent lamps, low-voltage halogen lights with conventional or electronic transformers, 230 V halogen lamps and dimmable energy-saving halogen lamps. Automatic load detection (can be deactivated). Separate N-connection per channel. Parallel connection of the outputs possible to increase the output power. Outputs can be connected in parallel in groups. Minimum load: 2 W. Manual operation on device also possible without bus voltage or in an unprogrammed status. Programming of the device also possible without applied 230 V supply voltage. Extensive test and diagnosis functions for the i-bus® Tool. Fast parameter setting in ETS using copyable channel templates. With integrated bus coupler.

Nominal power at 230 V~ mains voltage:

- 230 V~ incandescent and halogen lamps: 4 x 315 W/VA to 2 x 500 W/VA in trailing edge control, 4 x 120 W/VA to 2 x 200 W/VA in leading edge control.
 - Dimmable 230 V~ LEDi: 4 x 315 W/VA to 2 x 500 W/VA in trailing edge control, 4 x 120 W/VA to 2 x 200 W/VA in leading edge control.
 - Inductive L-transformers with LED/low-voltage halogen lamp: 4 x 315 W/VA to 2 x 500 W/VA.
 - Electronic C-transformers with LED/low-voltage halogen lamp: 4 x 315 W/VA to 2 x 500 W/VA.
 - Electronic LC-transformers with LED/low-voltage halogen lamp: 4 x 120 W/VA to 2 x 200 W/VA.
- Recommendation: Always use bulbs of one type and manufacturer.

Description	Mod. width	Order details		Price	Weight	Pack
		Type code	Order code	1 piece	1 piece	unit
	8	UD/S 4.315.2.1	2CKA006197A0057	€	kg	pc.
				0.56		1



UD/S 6.315.2.1

LED Dimmer, 6-fold, 315 W/VA, MDRC

Multichannel universal dimming actuator optimized for dimming of retrofit LED lamps (LEDi). Also suitable for dimming of incandescent lamps, low-voltage halogen lamps with conventional or electronic transformers, 230 V incandescent halogen lamps and dimmable halogen energy-saving lamps. Automatic load detection (deactivatable). One separate N-terminal per channel. Channel bridging possible in order to increase the maximum load. Outputs can be switched in parallel in groups as required. Minimum load: 2 W. Manual operation on the device is possible also without bus voltage or in unprogrammed state. One LED control button per channel (including status indication) for ON and OFF switching as well as for up and down dimming. Programming of the device is possible without connecting 230 V supply voltage. Comprehensive test and diagnostic functions via the i-bus® Tool. Fast parameterization in the ETS by means of copyable channel templates. With integrated bus coupler.

Rated power at 230 V ~:

- 230 V ~ incandescent and halogen lamps: 6 x 315 W/VA, 2 x 700 W/VA to 3 x 500 W/VA.
- Dimmable 230 V ~ LEDi: 6 x 315 W/VA, 2 x 700 W/VA to 3 x 500 W/VA in trailing edge mode, 6 x 120 W/VA, 2 x 250 W/VA to 3 x 300 W/VA in leading edge mode.
- Inductive L-transformers with LED/low-voltage halogen lamps: 6 x 315 W/VA, 2 x 700 W/VA to 3 x 500 W/VA.
- Electronic C-transformers with LED/low voltage halogen lamps: 6 x 315 W/VA, 2 x 700 W/VA to 3 x 500 W/VA.
- Electronic LC transformers with LED/low-voltage halogen lamps: 6 x 120 W/VA, 2 x 250 W/VA to 3 x 300 W/VA.

Recommendation: Always use bulbs of one type and manufacturer.

Description	Mod. width	Order details		Price	Weight	Pack unit
		Type code	Order code	1 piece	1 piece	
				€	kg	pc.
	12	UD/S 6.315.2.1	2CKA006197A0061			1



6155/30-500

Build-In-Dimmer with constant curve for LED-strips RGBW, 4-fold

Build-in LED-Dimmer for LED strips with constant curve. To control RGB or RGBW-LEDs. Grouping of channels possible. With Master/Slave-function and internal load management. Connections: KNX-line: Bus connection terminal. Rated voltage: 12 - 24 V. Output voltage: 12 V. Secondary: 24 V. Rated frequency: 600 Hz. Outputs: 4x dimming channel. Suitable for: DC. Rated current: 10 A. Rated power: 240 W. Protection class (Device): IP 20. Temperature range (Device): -5 °C to 45 °C. Dimensions: (L x W x D): 33 mm x 53 mm x 95 mm.

Description	Mod. width	Order details		Price	Weight	Pack unit
		Type code	Order code	1 piece	1 piece	
				€	kg	pc.
	-	6155/30-500	2CKA006151A0254		0.185	1

ABB i-bus® KNX Lighting Control



6155/40-500

Build-In-Dimmer with constant curve for LED-strips RGBW, 4-fold, with integrated power supply

Build-in LED-Dimmer for LED strips with constant curve. To control RGB or RGBW-LEDs. With integrated power adapter. Grouping of channels possible. With Master/Slave-function and internal load management. Connections: KNX-line: Bus connection terminal. Rated voltage: 230 V~. Output voltage: 24 V~. Rated frequency: 600 Hz. Outputs: 4x dimming channel. Suitable for: DC. Rated current: 4 A. Rated power: 100 W. Protection class (Device): IP 20. Temperature range (Device): -5 °C to 45 °C. Dimensions: (L x W x D): 45 mm x 53 mm x 226 mm.

Description	Mod. width	Order details		Price	Weight	Pack
		Type code	Order code	1 piece	1 piece	unit
				€	kg	pc.
	-	6155/40-500	2CKA006151A0256		0.4	1



HS/S 4.2.1

Outside Light Sensor Interface, MDRC

The device is used for the connection and evaluation of up to 3 Outside Light Sensors LFO/A 1.1. The Outside Light Sensors can be analysed individually or combined. Amongst others 10 logical switching channels for the evaluation of threshold values are provided. Threshold values can be adjusted directly on the device. The device can be used as a twilight switch (1 ... 100 lx) or as a light value switch (100 ... 100.000 lx). One Outside Light Sensor LFO/A 1.1 is supplied with the device.

Description	Mod. width	Order details		Price	Weight	Pack
		Type code	Order code	1 piece	1 piece	unit
				€	kg	pc.
	3	HS/S 4.2.1	2CDG120044R0011		0.24	1



LFO/A 1.1

Outside Light Sensor for HS/S4.2.1, SM

Outside Light Sensor for the connection with the Interface HS/S 4.2.1. Temperature range (sensor): -40 °C to +70 °C.

Description	Mod. width	Order details		Price	Weight	Pack
		Type code	Order code	1 piece	1 piece	unit
				€	kg	pc.
	-	LFO/A 1.1	2CDG120045R0011		0.05	1

ABB i-bus® KNX

Movement and Presence Detection

	Mini Basic	Mini Premium	Basic	Premium	Sky	Corridor Basic	Corridor Premium
	6131/20-xxx-500	6131/21-xxx-500	6131/30-xxx-500	6131/31-xxx-500	6131/40-xxx-500	6131/50-xxx-500	6131/51-xxx-500
General							
Supply voltage	KNX	KNX	KNX	KNX	KNX	KNX	KNX
Type of installation	flush-mounted/ surface-mounted	flush-mounted/ surface-mounted	flush-mounted/ surface-mounted	flush-mounted/ surface-mounted	flush-mounted/ surface-mounted	flush-mounted/ surface-mounted	flush-mounted/ surface-mounted
Programming button accessible from outside	■	■	■	■	-	■	■
Detection range diameter (sitting / walking person)						Corridor: only walking person	Corridor: only walking person
Installation height 2.5 m	Max. 5.0 m/ 6.5 m	Max. 5.0 m/ 6.5 m	Max. 8.0 m/ 10.0 m	Max. 8.0 m/ 10.0 m	-	Frontal: max. 18 x 2,5 m; Lateral: max. 24 x 2,5 m	Frontal: max. 18 x 2,5 m; Lateral: max. 24 x 2,5 m
Installation height 3.0 m	Max. 6.5 m/ 8.0 m	Max. 6.5 m/ 8.0 m	Max. 10.0 m/ 12.0 m	Max. 10.0 m/ 12.0 m	-	Frontal: max. 20 x 3 m; Lateral: max. 30 x 3 m	Frontal: max. 20 x 3 m; Lateral: max. 30 x 3 m
Installation height 4.0 m	Max. 9.0 m/ 10.5 m	Max. 9.0 m/ 10.5 m	Max. 14.0 m/ 16.0 m	Max. 14.0 m/ 16.0 m	-	Frontal: max. 20 x 3 m; Lateral: max. 30 x 3 m	Frontal: max. 20 x 3 m; Lateral: max. 30 x 3 m
Installation height 6.0 m	-	-	-	-	Max. 18.0 m	-	-
Installation height 12.0 m	-	-	-	-	Max. 24.0 m	-	-
Number of channels							
Movement detector	2	4 in total	2	4 in total	2	2	4 in total
Constant light switch	2	4 in total	2	4 in total	2	2	4 in total
Combination	1 x each	4 in total	1 x each	4 in total	1 x each	1 x each	4 in total
Constant light controller	-	2	-	2	-	-	2
Heating/cooling/ventilation systems (HVAC)	-	1	-	1	-	-	1
Infrared receiver, can be operated via IR remote control 6010-25	-	10 button pairs + 4 single buttons/ 24 single buttons	-	10 button pairs + 4 single buttons/ 24 single buttons	(only red for activation of the programming mode)	-	10 button pairs + 4 single buttons/ 24 single buttons
Two power-off stages							
Movement detector	■	■	■	■	■	■	■
Constant light control	-	■	-	■	-	-	■

■ = Function is supported

- = Function is not supported

ABB i-bus® KNX

Movement and Presence Detection

	Mini Basic	Mini Premium	Basic	Premium	Sky	Corridor Basic	Corridor Premium
	6131/20-xxx-500	6131/21-xxx-500	6131/30-xxx-500	6131/31-xxx-500	6131/40-xxx-500	6131/50-xxx-500	6131/51-xxx-500
Application							
Surveillance detector	■	■	■	■	■	■	■
Movement detector	■	■	■	■	■	■	■
Presence detector	■	■	■	■	–	■	■
Constant light switch	■	■	■	■	■	■	■
Controller independent of movement	–	■	–	■	–	–	■
Various							
Integrated object room temperature controller with temperature sensor	–	1	–	1	–	–	1
Brightness measurement	■	■	■	■	■	■	■
Calibration of brightness sensor via ETS group objects	■	■	■	■	■	■	■
Programming mode can be activated via IR remote control 6010-25	–	■	–	■	■	–	■
Programming LED can be activated via ETS group objects	■	■	■	■	■	■	■
Number of logic functions (4 different ones)	–	5	–	5	–	–	5

- = Function is not supported
 ■ = Function is supported



6131/20-24-500

Busch-Presence Detector, Mini, Basic, 8 Meter, SM

Presence detector with 4 individual PIR sensors (single switch-off) and 2 independent channels. Detection range (for mounting height 2.5 m, 3 m and 4 m): 360° (circular). Seated persons Ø: 5 m, 6,5 m and 9 m. Walking persons Ø: 6,5 m, 8 m and 10,5 m. Sensitivity of the watchdog adjustable via ETS-parameter.

Operating modes: Automatic, Automatic switch-off/switch-on (depending on detector application). For switching on/off light bands depending on the room brightness.

Regulation in response to the movement possible.

Using the device as presence and/or movement detector.

2 channels for detector application with integrated monitoring function or up to 2 channels for constant light switch application (max. 2 outputs for brightness dependent switching of two light bands in the area).

Integrated brightness sensor.

Weighting of up to 2 external brightness values and the internal brightness sensor possible.

Brightness range: 1 - 1000 Lux.

Brightness adjustment via KNX communication objects.

Two-stage switch-off with delay time and reduced brightness.

The KNX programming button is accessible without demounting the detector.

The KNX programming LED can be activated for the walk-test function via KNX.

With integrated KNX bus coupler and power supply via KNX bus.

Scene control via KNX.

Easy Master-Slave operation of several presence detectors possible.

Firmware update via ETS and KNX Firmware Update App.

Mounting height: 2 m - 4 m.

Suitable for false ceilings with a board thickness from 9 to 25 mm in combination with a spring clip.

Hole size: Ø 68 mm.

Suitable for surface mounting installations in combination with the surface-mounted box 6131/29-xxx(-500).

Cannot be installed in British Standard or VDE flush-mounted box.

Recommendation: Installation housing from Kaiser HaloX-O (Art.no. 1290-40) with corresponding cover plates (1290-47 or 1290-85 for fair faced concrete) or IBTronic H120-68 from Spelsberg.

Dimensions: (L x W x D): 80 mm x 80 mm x 45 mm.

Visible height: 16 mm.

Mounting depth: 29 mm.

Temperature range (device): -5 °C – 45 °C.

Storage temperature range: -25 °C – 55 °C.

Transport temperature range: -25 °C – 70 °C.

Protection class (device): IP 20.

For software and description please check the current Online-Catalogue.

Description	Mod. width	Order details		Price 1 piece	Weight 1 piece	Pack unit
		Type code	Order code			
studio white matt	-	6131/20-24-500	2CKA006132A0342	€ 0.13	kg 1	pc. 1
aluminium silver	-	6131/20-183-500	2CKA006132A0343	€ 0.13	kg 1	pc. 1

ABB i-bus® KNX

Movement and Presence Detection



6131/21-24-500

Busch-Presence Detector, Mini, Premium, 8 Meter, SM

Presence detector with 4 individual PIR sensors (single switch-off) and 4 independent channels. Detection range (for mounting height 2.5 m, 3 m and 4 m): 360° (circular). Seated persons Ø: 5 m, 6,5 m and 9 m. Walking persons Ø: 6,5 m, 8 m and 10,5 m. Sensitivity of the watchdog adjustable via ETS-parameter.

Operating modes: Automatic, Automatic switch-off/switch-on (depending on detector application). For dimming/control the brightness to a defined value in the detection area. 4 channels for detector application with integrated monitoring function or up to 4 channels for constant light switch application (max. 2 outputs for brightness dependent switching of two light bands in the area) or up to 2 channels for constant light control (max. 2 outputs for dimming daylight control/control of two rooflights in the room) or up to 1 channel for HVAC functions for controlling heating and/or cooling systems and ventilation systems in the detection area. Integrated brightness sensor. Weighting of up to 2 external brightness values and the internal brightness sensor possible. Brightness range: 1 - 1000 Lux. Brightness adjustment via KNX communication objects. Two-stage switch-off with delay time and reduced brightness. Incl. 5 logic functions (logic gates, gates, delay and staircase lighting). Integrated object room temperature controller with temperature sensor. The KNX programming button is accessible without demounting the detector. The KNX programming LED can be activated for the walk-test function via KNX. With integrated KNX bus coupler and power supply via KNX bus. Scene control via KNX. Easy Master-Slave operation of several presence detectors possible. Firmware update via ETS and KNX Firmware Update App. Integrated IR receiver for activation of the KNX programming mode via the IR remote control 6010-25(-500) and 10 freely programmable IR channels (blue and/or white function buttons). Alternatively via a teachable IR remote control with RC5 code. Mounting height: 2 m - 4 m. Suitable for false ceilings with a board thickness from 9 to 25 mm in combination with a spring clip. Hole size: Ø 68 mm. Suitable for surface mounting installations in combination with the surface-mounted box 6131/29-xxx(-500). Cannot be installed in British Standard or VDE flush-mounted box. Recommendation: Installation housing from Kaiser HaloX-O (Art.no. 1290-40) with corresponding cover plates (1290-47 or 1290-85 for fair faced concrete) or IBTronic H120-68 from Spelsberg. Dimensions: (L x W x D): 80 mm x 80 mm x 45 mm. Visible height: 16 mm. Mounting depth: 29 mm. Temperature range (device): -5 °C – 45 °C. Storage temperature range: -25 °C – 55 °C. Transport temperature range: -25 °C – 70 °C. Protection class (device): IP 20. For software and description please check the current Online-Catalogue. HVAC = Heating, Ventilation and Air Conditioning

Description	Mod. width	Order details		Price 1 piece	Weight 1 piece	Pack unit
		Type code	Order code			
studio white matt	-	6131/21-24-500	2CKA006132A0344		0.13	1
aluminium silver	-	6131/21-183-500	2CKA006132A0345		0.13	1



6131/30-24-500

Busch-Presence Detector, Basic, 12 Meter, SM

Presence detector with 4 individual PIR sensors (single switch-off) and 2 independent channels. Detection range (for mounting height 2.5 m, 3 m and 4 m): 360° (circular). Seated persons Ø: 8 m, 10 m and 14 m. Walking persons Ø: 10 m, 12 m and 16 m. Sensitivity of the watchdog adjustable via ETS-parameter. Operating modes: Automatic, Automatic switch-off/switch-on (depending on detector application). For switching on/off light bands depending on the room brightness. Regulation in response to the movement possible. Using the device as presence and/or movement detector. 2 channels for detector application with integrated monitoring function or up to 2 channels for constant light switch application (max. 2 outputs for brightness dependent switching of two light bands in the area). Integrated brightness sensor. Weighting of up to 2 external brightness values and the internal brightness sensor possible. Brightness range: 1 - 1000 Lux. Brightness adjustment via KNX communication objects. Two-stage switch-off with delay time and reduced brightness. The KNX programming button is accessible without demounting the detector. The KNX programming LED can be activated for the walk-test function via KNX. With integrated KNX bus coupler and power supply via KNX bus. Scene control via KNX. Easy Master-Slave operation of several presence detectors possible. Firmware update via ETS and KNX Firmware Update App. Mounting height: 2 m - 4 m. Suitable for false ceilings with a board thickness from 9 to 25 mm in combination with a spring clip. Hole size: Ø 68 mm. Suitable for surface mounting installations in combination with the surface-mounted box 6131/29-xxx(-500) or intermediate ring for VDE flush-mounted box 6131/38-xxx(-500). Cannot be installed in British Standard or VDE flush-mounted box. Recommendation: Installation housing from Kaiser HaloX-O (Art.no. 1290-40) with corresponding cover plates (1290-47 or 1290-85 for fair faced concrete) or IBTronic H120-68 from Spelsberg. Dimensions: (L x W x D): 91 mm x 91 mm x 45 mm. Visible height: 23 mm. Mounting depth: 22 mm. Temperature range (device): -5 °C – 45 °C. Storage temperature range: -25 °C – 55 °C. Transport temperature range: -25 °C – 70 °C. Protection class (device): IP 20. For software and description please check the current Online-Catalogue.

Description	Mod. width	Order details		Price 1 piece	Weight 1 piece	Pack unit
		Type code	Order code			
studio white matt	-	6131/30-24-500	2CKA006132A0346	€	kg	pc.
aluminium silver	-	6131/30-183-500	2CKA006132A0347	0.15	1	1

ABB i-bus® KNX

Movement and Presence Detection



6131/31-24-500

Busch-Presence Detector, Premium, 12 Meter, SM

Presence detector with 4 individual PIR sensors (single switch-off) and 4 independent channels. Detection range (for mounting height 2.5 m, 3 m and 4 m): 360° (circular). Seated persons Ø: 8 m, 10 m and 14 m. Walking persons Ø: 10 m, 12 m and 16 m. Sensitivity of the watchdog adjustable via ETS-parameter.

Operating modes: Automatic, Automatic switch-off/switch-on (depending on detector application). For dimming/control the brightness to a defined value in the detection area. 4 channels for detector application with integrated monitoring function or up to 4 channels for constant light switch application (max. 2 outputs for brightness dependent switching of two light bands in the area) or up to 2 channels for constant light control (max. 2 outputs for dimming daylight control/control of two rooflights in the room) or up to 1 channel for HVAC functions for controlling heating and/or cooling systems and ventilation systems in the detection area.

Integrated brightness sensor.
Weighting of up to 2 external brightness values and the internal brightness sensor possible.
Brightness range: 1 - 1000 Lux.
Brightness adjustment via KNX communication objects.
Two-stage switch-off with delay time and reduced brightness.
Incl. 5 logic functions (logic gates, gates, delay and staircase lighting).
Integrated object room temperature controller with temperature sensor.
The KNX programming button is accessible without demounting the detector.
The KNX programming LED can be activated for the walk-test function via KNX.
With integrated KNX bus coupler and power supply via KNX bus.
Scene control via KNX.
Easy Master-Slave operation of several presence detectors possible.
Firmware update via ETS and KNX Firmware Update App.
Integrated IR receiver for activation of the KNX programming mode via the IR remote control 6010-25(-500) and 10 freely programmable IR channels (blue and/or white function buttons). Alternatively via a teachable IR remote control with RC5 code.
Mounting height: 2 m - 4 m.
Suitable for false ceilings with a board thickness from 9 to 25 mm in combination with a spring clip.
Hole size: Ø 68 mm.
Suitable for surface mounting installations in combination with the surface-mounted box 6131/29-xxx(-500).
Cannot be installed in British Standard or VDE flush-mounted box.
Recommendation: Installation housing from Kaiser HaloX-O (Art.no. 1290-40) with corresponding cover plates (1290-47 or 1290-85 for fair faced concrete) or IBTronic H120-68 from Spelsberg.
Dimensions: (L x W x D): 91 mm x 91 mm x 45 mm.
Visible height: 23 mm.
Mounting depth: 22 mm.
Temperature range (device): -5 °C – 45 °C.
Storage temperature range: -25 °C – 55 °C.
Transport temperature range: -25 °C – 70 °C.
Protection class (device): IP 20.
For software and description please check the current Online-Catalogue.
HVAC = Heating, Ventilation and Air Conditioning

Description	Mod. width	Order details		Price 1 piece	Weight 1 piece	Pack unit
		Type code	Order code			
studio white matt	-	6131/31-24-500	2CKA006132A0348		0.15	1
aluminium silver	-	6131/31-183-500	2CKA006132A0349		0.15	1



6131/40-24-500

Presence Detector, Sky, white, SM

Movement detector with 4 individual PIR sensors (single switch-off) and 2 independent channels. Detection range (for mounting height 6 m and 12 m): 360° (circular).

Walking persons Ø: 18 m, 24 m.

Sensitivity of the watchdog adjustable via ETS-parameter.

Operating modes: Automatic, Automatic switch-off/switch-on (depending on detector application).

For switching on/off light bands depending on the room brightness.

Regulation in response to the movement possible.

Using the device as presence and/or movement detector.

2 channels for detector application with integrated monitoring function or up to 2 channels for constant light switch application (max. 2 outputs for brightness dependent switching of two light bands in the area).

Integrated brightness sensor.

Weighting of up to 2 external brightness values and the internal brightness sensor possible.

Brightness range: 1 - 1000 Lux.

Brightness adjustment via KNX communication objects.

Two-stage switch-off with delay time and reduced brightness.

The KNX programming button is accessible without demounting the detector.

The KNX programming LED can be activated for the walk-test function via KNX.

With integrated KNX bus coupler and power supply via KNX bus.

Scene control via KNX.

Easy Master-Slave operation of several presence detectors possible.

Firmware update via ETS and KNX Firmware Update App.

Integrated IR receiver for activation of the KNX programming mode via the IR remote control 6010-25(-500). Alternatively via a teachable IR remote control with RC5 code.

Mounting height: 4 to 12 m.

Suitable for false ceilings with a board thickness from 9 to 25 mm in combination with a spring clip.

Hole size: Ø 68 mm.

Suitable for surface mounting installations in combination with the surface-mounted box 6131/29-xxx(-500) or intermediate ring for VDE flush-mounted box 6131/38-xxx(-500).

Cannot be installed in British Standard or VDE flush-mounted box.

Recommendation: Installation housing from Kaiser HaloX-O (Art.no. 1290-40) with corresponding cover plates (1290-47 or 1290-85 for fair faced concrete) or IBTronic H120-68 from Spelsberg.

Dimensions: (L x W x D): 91 mm x 91 mm x 45 mm.

Visible height: 23 mm.

Mounting depth: 22 mm.

Temperature range (device): -5 °C – 45 °C.

Storage temperature range: -25 °C – 55 °C.

Transport temperature range: -25 °C – 70 °C.

Protection class (device): IP 20.

For software and description please check the current Online-Catalogue.

Description	Mod. width	Order details		Price	Weight	Pack
		Type code	Order code	1 piece	1 piece	unit
				€	kg	pc.
studio white matt	-	6131/40-24-500	2CKA006132A0350		0.15	1

ABB i-bus® KNX

Movement and Presence Detection



6131/50-24-500

Presence Detector, Corridor, Basic, FM

Presence detector with 2 sensor groups and 2 PIR sensors each (groups single switch-off) and max. 2 independent channels. Detection range: rectangular.

For mounting height 2.5 m: frontal approach max. 18 m x 2.5 m (per side max. 9 m x 2.5 m).

Lateral movement max. 24 m x 2.5 m (per side max. 12 m x 2.5 m).

For mounting height 3 m as well as 4 m: frontal approach max. 20 m x 3 m (per side max. 10 m x 3 m). Lateral movement max. 30 m x 3 m (per side max. 15 m x 3 m).

Sensitivity of the watchdog adjustable via ETS-parameter.

Operating modes: Automatic, Automatic switch-off/switch-on (depending on detector application).

For switching on/off light bands depending on the room brightness.

Regulation in response to the movement possible.

Using the device as presence and/or movement detector.

2 channels for detector application with integrated monitoring function

or up to 2 channels for constant light switch application (max. 2 outputs for brightness dependent switching of two light bands in the area).

Integrated brightness sensor.

Weighting of up to 2 external brightness values and the internal brightness sensor possible.

Brightness range: 1 - 1000 Lux.

Brightness adjustment via KNX communication objects.

Two-stage switch-off with delay time and reduced brightness.

The KNX programming button is accessible without demounting the detector.

The KNX programming LED can be activated for the walk-test function via KNX.

With integrated KNX bus coupler and power supply via KNX bus.

Scene control via KNX.

Easy Master-Slave operation of several presence detectors possible.

Firmware update via ETS and KNX Firmware Update App.

Mounting height: 2 m - 4 m.

Suitable for false ceilings with a board thickness from 9 to 25 mm in combination with a spring clip.

Hole size: Ø 68 mm.

Suitable for surface mounting installations in combination with the surface-mounted box 6131/29-xxx(-500) or intermediate ring for VDE flush-mounted box 6131/38-xxx(-500).

Cannot be installed in British Standard or VDE flush-mounted box.

Recommendation: Installation housing from Kaiser HaloX-O (Art.no. 1290-40) with corresponding cover plates (1290-47 or 1290-85 for fair faced concrete) or IBTronic H120-68 from Spelsberg.

Dimensions: (L x W x D): 91 mm x 91 mm x 49 mm.

Visible height: 27 mm.

Mounting depth: 22 mm.

Temperature range (device): -5 °C – 45 °C.

Storage temperature range: -25 °C – 55 °C.

Transport temperature range: -25 °C – 70 °C.

Protection class (device): IP 20.

For software and description please check the current Online-Catalogue.

Description	Mod. width	Order details		Price	Weight	Pack
		Type code	Order code	1 piece	1 piece	unit
				€	kg	pc.
studio white matt	-	6131/50-24-500	2CKA006132A0399		0.16	1
aluminium silver	-	6131/50-183-500	2CKA006132A0400		0.16	1



6131/51-24-500

Presence Detector, Corridor, Premium, FM

Presence detector with 2 sensor groups and 2 PIR sensors each (groups single switch-off) and max. 4 independent channels. Detection range: rectangular.

For mounting height 2.5 m: frontal approach max. 18 m x 2.5 m (per side max. 9 m x 2.5 m).

Lateral movement max. 24 m x 2.5 m (per side max. 12 m x 2.5 m).

For mounting height 3 m as well as 4 m: frontal approach max. 20 m x 3 m (per side max.

10 m x 3 m). Lateral movement max. 30 m x 3 m (per side max. 15 m x 3 m).

Sensitivity of the watchdog adjustable via ETS-parameter.

Operating modes: Automatic, Automatic switch-off/switch-on (depending on detector application).

For dimming/control the brightness to a defined value in the detection area.

4 channels for detector application with integrated monitoring function

or up to 4 channels for constant light switch application (max. 2 outputs for brightness dependent switching of two light bands in the area)

or up to 2 channels for constant light control (max. 2 outputs for dimming daylight control/control of two rooflights in the room)

or up to 1 channel for HVAC functions for controlling heating and/or cooling systems and ventilation systems in the detection area. Integrated brightness sensor.

Weighting of up to 2 external brightness values and the internal brightness sensor possible.

Brightness range: 1 - 1000 Lux. Brightness adjustment via KNX communication objects.

Two-stage switch-off with delay time and reduced brightness.

Incl. 5 logic functions (logic gates, gates, delay and staircase lighting).

Integrated object room temperature controller with temperature sensor.

The KNX programming button is accessible without demounting the detector.

The KNX programming LED can be activated for the walk-test function via KNX.

With integrated KNX bus coupler and power supply via KNX bus.

Scene control via KNX. Easy Master-Slave operation of several presence detectors possible.

Firmware update via ETS and KNX Firmware Update App.

Integrated IR receiver for activation of the KNX programming mode via the IR remote control 6010-25(-500) and 10 freely programmable IR channels (blue and/or white function buttons).

Alternatively via a teachable IR remote control with RC5 code.

Mounting height: 2 m - 4 m.

Suitable for false ceilings with a board thickness from 9 to 25 mm in combination with a spring clip. Hole size: Ø 68 mm.

Suitable for surface mounting installations in combination with the surface-mounted box 6131/29-xxx(-500).

Cannot be installed in British Standard or VDE flush-mounted box.

Recommendation: Installation housing from Kaiser HaloX-O (Art.no. 1290-40) with corresponding cover plates (1290-47 or 1290-85 for fair faced concrete) or IBTronic H120-68 from Spelsberg.

Dimensions: (L x W x D): 91 mm x 91 mm x 49 mm.

Visible height: 27 mm.

Mounting depth: 22 mm.

Temperature range (device): -5 °C – 45 °C.

Storage temperature range: -25 °C – 55 °C.

Transport temperature range: -25 °C – 70 °C.

Protection class (device): IP 20.

For software and description please check the current Online-Catalogue.

HVAC = Heating, Ventilation and Air Conditioning

Description	Mod. width	Order details		Price 1 piece	Weight 1 piece	Pack unit
		Type code	Order code			
studio white matt	-	6131/51-24-500	2CKA006132A0413	€	kg	pc.
aluminium silver	-	6131/51-183-500	2CKA006132A0414	0.16	0.16	1

ABB i-bus® KNX

Movement and Presence Detection



6131/29-24-500

Housing Presence Detector, Mini, Basic, SM

For installing a Busch-Presence detector mini KNX 6131/20-xxx(-500) or a Busch-Presence detector mini premium KNX 6131/21-xxx(-500).

Protection class (Device): IP 20. Dimensions: (L x W x D): 80 mm x 80 mm x 35 mm.

Description	Mod. width	Order details		Price	Weight	Pack unit
		Type code	Order code	1 piece	1 piece	
				€	kg	pc.
studio white matt	–	6131/29-24-500	2CKA006132A0351		0.08	1
aluminium silver	–	6131/29-183-500	2CKA006132A0352		0.08	1



6131/39-24-500

Housing Presence Detector, Mini, Premium, SM

For mounting a Busch-Presence detector KNX 6131/30-xxx(-500), a Busch-Presence detector premium KNX 6131/31-xxx(-500), a Busch-Presence detector Corridor KNX 6131/50-xxx(-500), a Busch-Presence detector Corridor premium KNX 6131/51-xxx(-500) or a Busch-Watchdog Sky KNX 6131/40-24(-500).

Protection class (Device): IP 20. Dimensions: (L x W x D): 91 mm x 91 mm x 33 mm.

Description	Mod. width	Order details		Price	Weight	Pack unit
		Type code	Order code	1 piece	1 piece	
				€	kg	pc.
studio white matt	–	6131/39-24-500	2CKA006132A0353		0.10	1
aluminium silver	–	6131/39-183-500	2CKA006132A0354		0.10	1



6131/38-24

Intermediate ring for Busch-Presence detector Basic, Premium, Sky and Corridor

For mounting a Busch-Presence detector KNX 6131/30-xxx(-500), a Busch-Presence detector premium KNX 6131/31-xxx(-500), a Busch-Presence detector Corridor KNX 6131/50-xxx(-500), a Busch-Presence detector Corridor premium KNX 6131/51-xxx(-500) or a Busch-Watchdog Sky KNX 6131/40-24(-500).

Protection class (Device): IP 20. Dimensions: (L x W x D): 91 mm x 91 mm x 22 mm.

Description	Mod. width	Order details		Price	Weight	Pack unit
		Type code	Order code	1 piece	1 piece	
				€	kg	pc.
studio white matt	–	6131/38-24-500	2CKA006132A0403		0.08	1
aluminium silver	–	6131/38-183-500	2CKA006132A0404		0.08	1



6179/01-204-500

Watchdog Sensor, Basic, SM

Sensor angle: 220° Range: approx. 16 m. With 2 movement channels. With 1 twilight channel with 3 switching thresholds. No remote control possible via IR remote control KNX. With integrated KNX bus coupler. No additional power supply necessary.

Surveillance density: 92 sectors with 368 switching segments.

Twilight sensor: approx. 1 – 1000 lux. Switch-off delay: approx. 10 sec to 1092 min.

Description	Mod. width	Order details		Price	Weight	Pack unit
		Type code	Order code	1 piece	1 piece	
				€	kg	pc.
alpine white	–	6179/01-204-500	2CKA006132A0313		0.56	1
silver metallic	–	6179/01-208-500	2CKA006132A0314		0.56	1



6179/02-204-500

Watchdog Sensor, Premium, SM

Sensor angle: 220° Range: approx. 16 m. With 4 movement channels. With 1 twilight /brightness channel with 3 switching thresholds. With 1 temperature channel with three switching thresholds. With 7-channel IR remote control. Remote control possible via IR remote control KNX 6179 (included in scope of delivery). With integrated KNX bus coupler.

No additional power supply necessary. Surveillance density: 92 sectors with 368 switching segments. Twilight sensor: approx. 1 – 1000 lux; Brightness sensor: approx. 1 – 80 klux; Temperature sensor: approx. –25 to +55 °C; Switch-off delay: approx. 10 sec to 1092 min.

Description	Mod. width	Order details		Price	Weight	Pack unit
		Type code	Order code	1 piece	1 piece	
				€	kg	pc.
alpine white	–	6179/02-204-500	2CKA006132A0317		0.56	1
silver metallic	–	6179/02-208-500	2CKA006132A0318		0.56	1



6179-500

Infrared Hand Transmitter for Watchdog Sensor

For Busch-Watchdog 220 MasterLINE KNX premium. The functions can be freely assigned. With coded transmission signal. Power supply: lithium button cell battery. Type CR202 (included in delivery). Battery life: typically 2 years. Rated voltage: 3 V, Protection class (Device): IP 40, Temperature range (Device): 0 °C – 45 °C, Dimensions: (L x W x D): 86 mm x 40 mm x 7 mm.

Description	Mod. width	Order details		Price	Weight	Pack unit
		Type code	Order code	1 piece	1 piece	
				€	kg	pc.
grey / anthracite	–	6179-500	2CKA006132A0320		0.58	1

ABB i-bus® KNX

Movement and Presence Detection



6868-201-500

Ceiling/corner adapter

For Busch-Watchdog 220 MasterLINE, Busch-Watchdog 220 MasterLINE select, Busch-Watchdog 220 MasterLINE premium, Busch-Watchdog 280 MasterLINE, Busch-Watchdog 220 MasterLINE KNX, Busch-Watchdog 220 MasterLINE KNX premium. For detection on two sides of the house, in combination with Busch-Watchdog 280. For ceiling mounting of the Busch-Watchdog.

To increase the inclination of the Busch-Watchdog 220/280. It is mounted at the corner of the house, on the wall or under the ceiling. For flush or surface wiring.

Dimensions: (L x W x D): 102 mm x 125 mm x 55 mm. Mounting height: 2.5 m.

Description	Mod. width	Order details		Price	Weight	Pack unit
		Type code	Order code	1 piece	1 piece	
				€	kg	pc.
brown	–	6868-201-500	2CKA006800A2565		0.16	1
white		6868-204-500	2CKA006800A2562		0.16	1
silver metallic		6868-208-500	2CKA006800A2563		0.16	1
anthracite		6868-35-500	2CKA006800A2564		0.16	1

Efficient climate control in one system

ClimaECO the new product range for HVAC automation

Heating, ventilation, and air-conditioning automation – ClimaECO brings HVAC applications together in one holistic solution portfolio based on the standardized KNX system.

HVAC control in one single system

ClimaECO is the holistic heating, ventilation, and air-conditioning (HVAC) automation solution for commercial buildings based on the proven ABB i-bus® KNX system. A solution that seamlessly integrates room automation, central HVAC functions, and management and automation into one system – a significant step towards increasing energy efficiency and reducing operational costs. ClimaECO – making your building more economical, sustainable, and comfortable.



—
When it comes to HVAC you often have to deal with several systems. ABB ClimaECO offers one solution for everything.

HVAC automation from the room level to the management level

HVAC – multiple functions

Heating, ventilation, and air-conditioning technology is made up of various systems that are now integrated into one system.

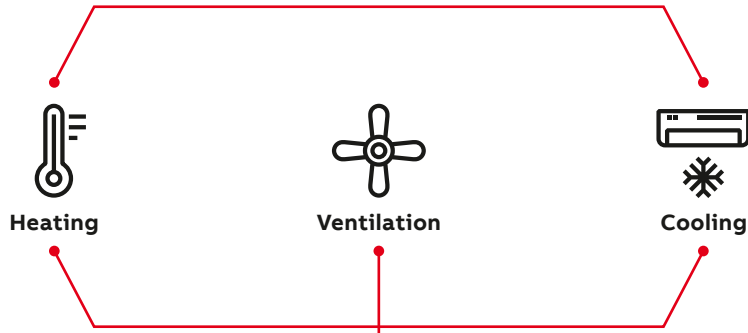

KNX – a standardized system

With the proven ABB i-bus® KNX system it is possible to automate all HVAC applications and combine them into a single solution.

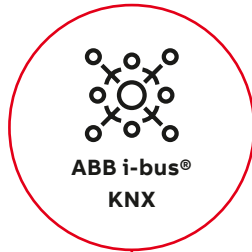

HVAC – levels

ClimaECO combines the three different levels of HVAC automation, ranging from management level to central HVAC systems (generation and distribution) to room automation (energy consumption).

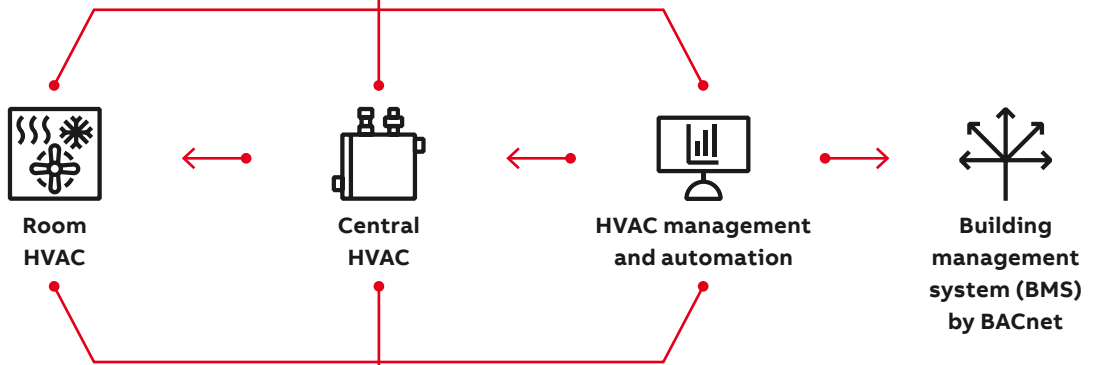

ClimaECO – a holistic solution

ClimaECO bundles all functions and solutions for HVAC automation into a single integrated system. This saves you time and effort with planning, integration, and maintenance, while significantly increasing energy efficiency in buildings.

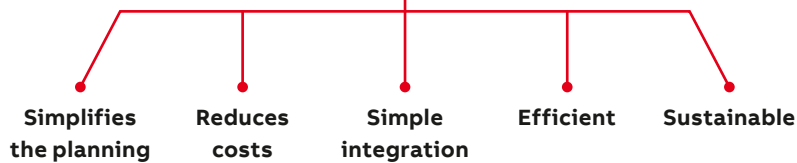
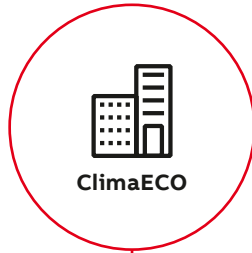

14

ABB i-bus® KNX

Heating, Ventilation and Air Conditioning – Influencing Variables on Room Climate

Influencing Variables on Room Temperature

Internal and external factors have an effect on the thermal conditions in a room or a building. As an external factor the solar radiation is important for the indoor temperature – particularly with regard to modern architecture with glass fronts. Besides this, the room temperature is strongly affected by the exchange of thermal energy through windows and walls as well as the loss of thermal energy through open doors and windows.

Depending on the intensity, all this interactions influence also the energy efficiency of a building and have therefore to be optimised.

Internal thermal inputs from lighting, devices or persons have also an influence on the room climate. By planning a heating, ventilation or air conditioning system all this internal and external factors have to be considered.

Influencing Variables on Air Quality

The indoor climate in living and working areas has a scientifically proven impact on health, job performance and well-being of people. A suitable indicator for determination of the room air quality is the CO₂ concentration. In addition the values for room temperature and air humidity must be controlled to meet the requirements for a comfortable room climate.

Studies have shown, that high CO₂ concentration in the air influences the well-being as well as the performance and learning ability of people. Besides the normal CO₂ concentration in the air, human respiration is an important factor increasing the CO₂ concentration in a room. Therefore it is important to measure the CO₂ concentration in rooms where many persons are present (schools, conference rooms, open-plan offices). Monitoring of thresholds enables fans to be switched via ABB i-bus® KNX allowing automatic control of the CO₂ concentration and sufficient supply of fresh air.



ABB i-bus® KNX

Heating, Ventilation and Air Conditioning –
ABB Tenton®

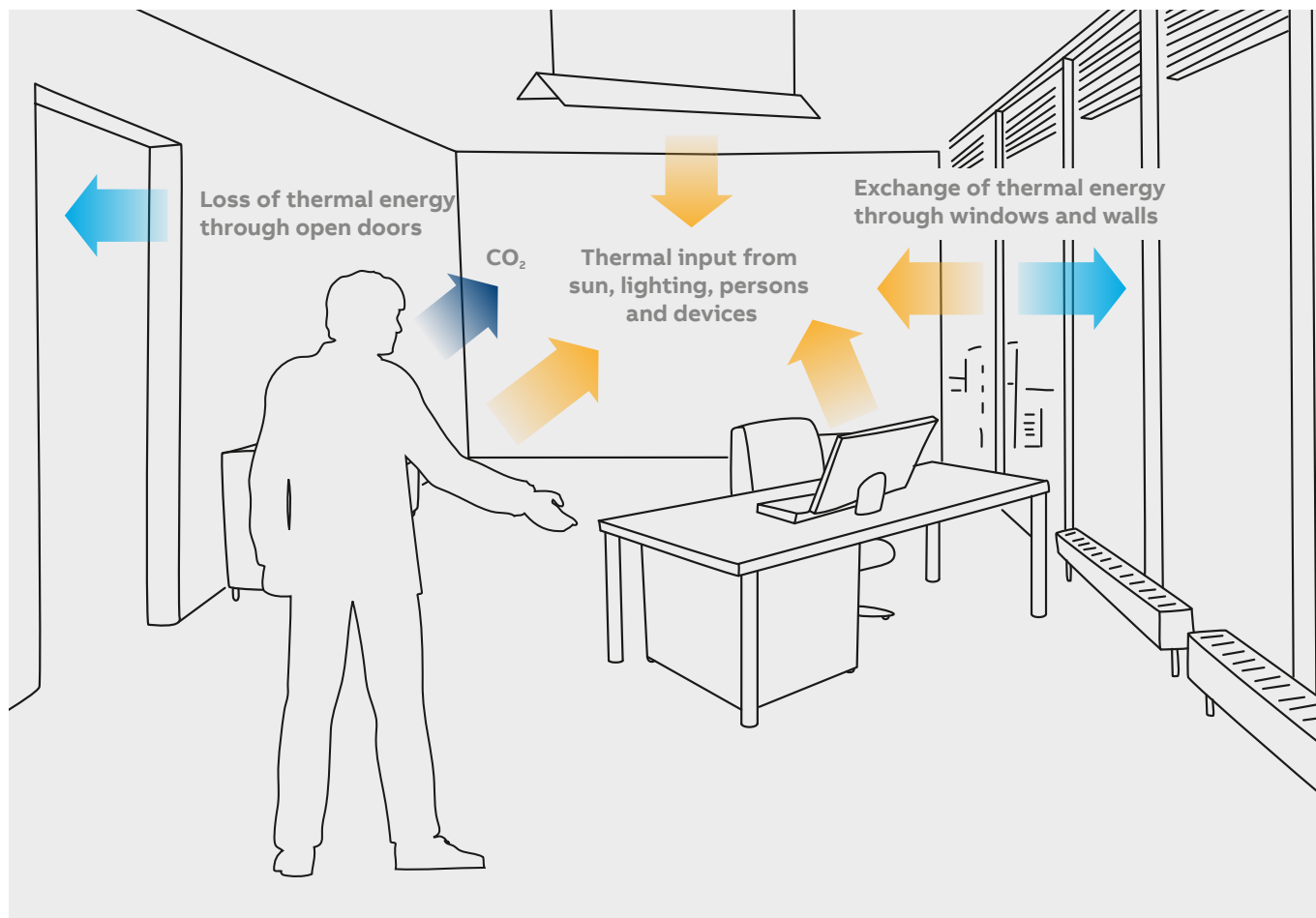

Living and working with a feeling of well-being.

And here the air in the room is one of the most important factors. Because the body takes an ideal temperature for granted and therefore easily reacts to changes. Heated or air-conditioned rooms can be optimally adjusted – to a consistently pleasant ambience.

The KNX ABB Tenton® for stand-alone applications.

The ABB Tenton® with display is a room temperature controller for ventilator convectors or conventional systems for heating and cooling. This option offers complete air-conditioning for rooms. The temperature can be adjusted precisely for personal comfort. The fan speeds can be selected by push buttons. Even very large rooms can be heated or cooled to a comfortable temperature quickly – with additional air-conditioning units. The KNX ABB Tenton® can be operated individually. The bus coupler is integrated into the control element.

Function

- Temperature sensor
- RTC setting
- Illuminated display
- Fan Coil operation for heating and cooling

Features

- Very easy to operate with large, clear display
- Complete air conditioning
- Fan speeds can be manually selected
- Integrated bus coupler
- Surface-mounted, independent switching program
- Available in four modern colours

ABB i-bus® KNX

Heating, Ventilation and Air Conditioning –
ClimaECO Portfolio Overview



ABB i-bus® KNX

Heating, Ventilation and Air Conditioning

	Electronic Switch Actuator ES/S x.1.2.1 (x = 4/8)	Electronic Relay ER/U 1.1 (with US/U x.2) (x = 2/4)	Valve Drive Actuator VAA/S x.230.2.1 (x = 6/12)	Valve Drive Controller VC/S 4.1.1	Valve Drive Controller VC/S 4.2.1
General					
Supply voltage	KNX	24...250 V AC/DC	KNX	KNX	KNX
Type of installation	DIN-Rail	Flush-mounted	DIN-Rail	DIN-Rail	DIN-Rail
Module width (18 mm)	4/8	–	4/8	8	8
Current consumption, bus	< 12 mA	< 12 mA	< 12 mA	< 12 mA	< 12 mA
Rated current (per channel)	1 A (resistive load)	0.5 A (resistive load)	160 mA (resistive load)	250 mA	250 mA
Inrush current (per channel)	8 A (1 s, Tu = 20 °C)	1.2 A (1 min.)	300 mA (2 min., Tu = 60 °C)	300 mA (2 min., Tu = 60 °C)	300 mA (2 min., Tu = 60 °C)
Maximum number of thermoelectric valve drives (per channel)	10 (230 V) 3 (24 V)	2 (230 V) 2 (24 V)	3 (230 V) 1 (24 V)	3 (230 V) 1 (24 V)	3 (230 V) 1 (24 V)
Outputs					
Number	4/8	1	6/12	4	4
Type	thermoelectric or motor valve drives	thermoelectric valve drives	thermoelectric valve drives	thermoelectric valve drives	thermoelectric valve drives
Output voltage	24... 230 V AC/DC	24... 230 V AC/DC	24...230 V AC	24...230 V AC	24...230 V AC
Manual operation					
Manual operation	■	–	■	–	■
Fault acknowledgement	■	–	■	–	■
Function:					
Operating mode Valve drive, thermoelectric/motor valve drives					
Forced operation	■	■ (via US/U x.2)	■	■	■
Status	■	–	■	■	■
Adjustable control value after controller fault	■	■ (via US/U x.2)	■	■	■
Valve purge	■	■ (via US/U x.2)	■	■	■
Characteristic curve adaption	■	–	■	–	–
Blocking	■	–	■	–	–
Operating mode Switch actuator					
Time:	■	–	–	–	–
Staircase lighting, delay, flashing	■	–	–	–	–
8-bit scene	■	–	–	–	–
Logical functions	■	–	–	–	–
Safety settings	■	–	–	–	–
Threshold values	■	–	–	–	–
Integrated room temperature controller (RTC)	–	–	–	■	■
Use in Master/Slave system with room operation units	–	–	–	■	■
Control and diagnosis via ABB i-bus® Tool	–	–	–	■	■

■ = Function is supported

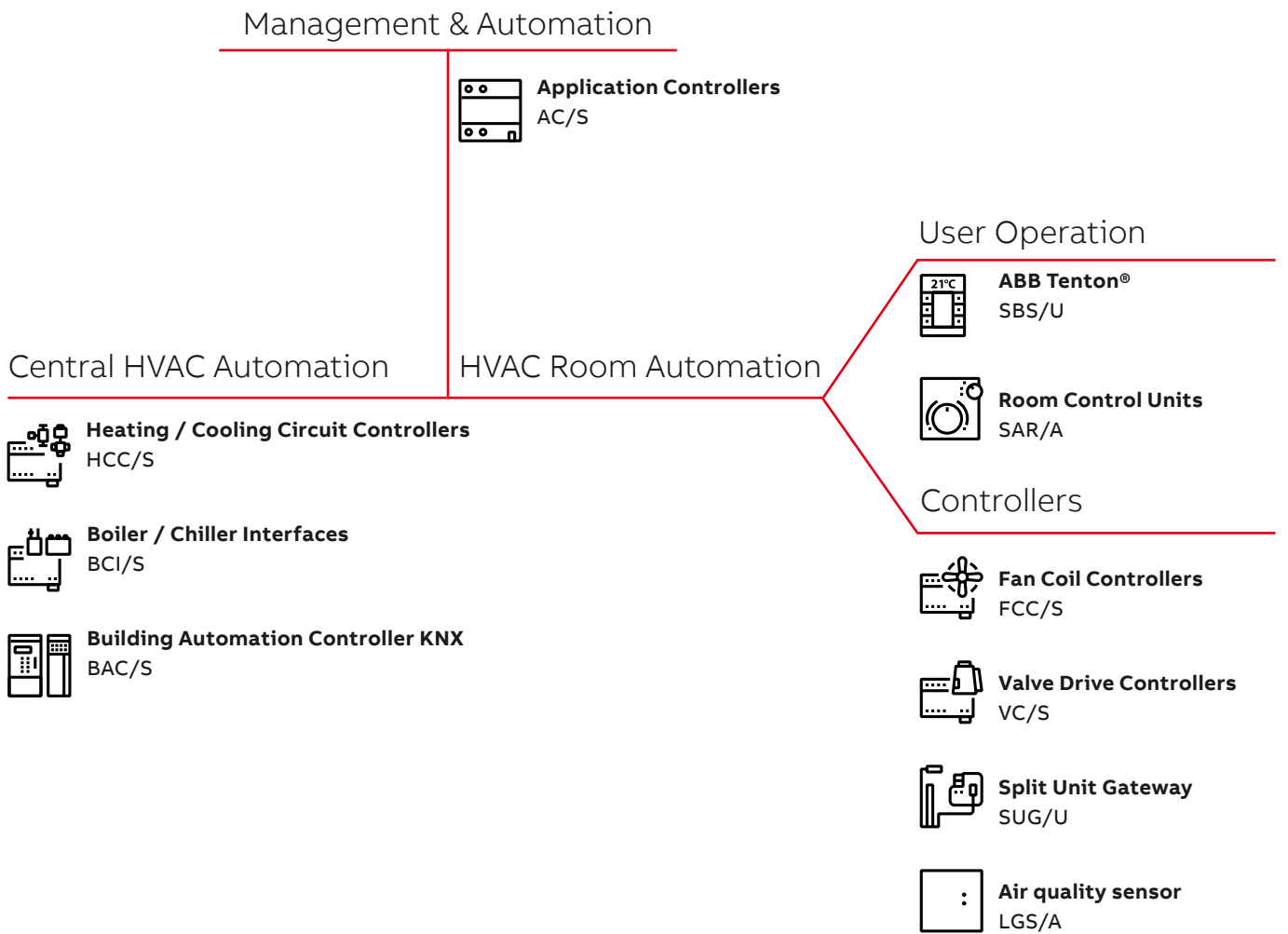
– = Function is not supported



VC/S 4.1.1

Valve Drive Controller, 4-fold, MDRC

For the control of heating and cooling applications in the room, such as radiator, floor heating or cooling ceiling. The device has 4 channels each for the independent control of a heating or cooling application. Each channel has an electronic valve output for the control of a thermoelectric valve drive, as well as 3 inputs to detect and monitor the room status (use for window contact, dew point sensor, level sensor or temperature sensor). Also it is possible to connect one analog room control unit (SAR/A or SAF/A) to the inputs of each channel. Each channel has its own integrated room temperature controller for the control of the room temperature, which can be used directly to control the outputs of the device. The VC/S 4.2.1 features an easy to use manual operation.

Both devices support the ABB i-bus® Tool for advanced diagnosis and improved commissioning.

Description	Mod. width	Order details		Price	Weight	Pack
		Type code	Order code	1 piece	1 piece	unit
				€	kg	pc.
	8	VC/S 4.1.1	2CDG110216R0011		0.27	1
Manual Operation	8	VC/S 4.2.1	2CDG110217R0011		0.275	1



VAA/S 6.230.2.1

Valve Drive Actuator, 230 V, MDRC

For controlling thermoelectric valve drives (e.g. TSA/K) in heating/cooling systems at 24...230 V AC. The outputs are protected against short circuits and overload and can be switched on or off via manual push buttons during commissioning.

Description	Mod. width	Order details		Price	Weight	Pack
		Type code	Order code	1 piece	1 piece	unit
				€	kg	pc.
6-fold	4	VAA/S 6.230.2.1	2CDG110116R0011		0.17	1
12-fold	8	VAA/S 12.230.2.1	2CDG110117R0011		0.3	1



VAA/A 6.24.2

Floor heating Controller, 6-fold, SM

For the control of up to twelve thermoelectric 24 V DC or analog 0-10 V valve drives (two per channel). With integrated power supply for the valve drives. The device has an integrated relay output to switch the heating circuit pump in dependence of the control value of the valve outputs. The valve outputs can be controlled by the internal or an external room temperature controller. The device is suitable for the installation in the (floor) heating distribution system.

Description	Mod. width	Order details		Price	Weight	Pack
		Type code	Order code	1 piece	1 piece	unit
				€	kg	pc.
	-	VAA/A 6.24.2	2CDG120061R0011		0.5	1

ABB i-bus® KNX

Heating, Ventilation and Air Conditioning



ES/S 4.1.2.1

Electronic Switch Actuator, 4-fold, 1 A, MDRC

Controls thermoelectric valve drives (e.g. TSA/K) in heating and cooling systems. Each output (24...230 V AC/DC) is protected against short-circuit and overload. With manual operation and status display for each output.

Description	Mod. width	Order details		Price	Weight	Pack unit
		Type code	Order code	1 piece	1 piece	
				€	kg	pc.
4-fold	4	ES/S 4.1.2.1	2CDG110058R0011		0.25	1
8-fold	8	ES/S 8.1.2.1	2CDG110059R0011		0.38	1



ER/U 1.1

Electronic Relay, 1-fold, FM

The device is used in combination with the universal interface US/U x.2 and a room thermostat to control the temperature in individual rooms. The thermal valve drives of the radiator valves are operated both noise-free and with a low rate of wear.

Description	Mod. width	Order details		Price	Weight	Pack unit
		Type code	Order code	1 piece	1 piece	
				€	kg	pc.
	-	ER/U 1.1	GHQ6310044R0111		0.08	1
2-fold	-	US/U 2.2	GHQ6310074R0111		0.06	1
4-fold	-	US/U 4.2	GHQ6310070R0111		0.06	1



6164/11 U-500

Heating Actuator, 1-fold, 230 V, FM

1 electronic output (noiseless). For connecting thermoelectric actuating drives. The device possesses three additional inputs. Rated voltage: 230 V~, +10% /-10%, 50 Hz – 60 Hz. Input polling voltage 5 V. Output Rated current: 25 mA, cos φ 1. Output voltage: 250 V~. The bus can be connected via enclosed terminal block.

Description	Mod. width	Order details		Price	Weight	Pack unit
		Type code	Order code	1 piece	1 piece	
				€	kg	pc.
	-	6164/11 U-500	2CKA006151A0247		0.09	1



ST/K 1.1

Electromotor Valve Drive

The drive is a proportional valve drive for controlling heating valves and is mounted on thermostat valve bases. Valve Adapters VA10, VA78 for conventional valves are supplied.

The control is carried out via a continuous KNX room thermostat. The actual valve position is indicated by 5 LEDs. The valve drive has two binary inputs for a presence contact and/or window contact and for further signal indication. With integrated Bus Coupler.

Description	Mod. width	Order details		Price	Weight	Pack unit
		Type code	Order code	1 piece	1 piece	
				€	kg	pc.
	-	ST/K 1.1	2CDG120004R0011		0.32	1



TSA/K 230.2

Thermoelectric Valve Drives

For opening and closing valves in heating, ventilation and air-conditioning systems. Both variants (230 V and 24 V) feature a plug-in connection cable (1 m) and a splash-proof housing. The mounting on the valve is easily implemented using the Valve Adapter VA/Z xx.1.

Description	Mod. width	Order details		Price	Weight	Pack
		Type code	Order code	1 piece	1 piece	unit
				€	kg	pc.
230 V	–	TSA/K 230.2	2CDG120049R0011		0.16	1
24 V	–	TSA/K 24.2	2CDG120050R0011		0.16	1
Valve Adapter for valves from Dumser, Chronatherm, Vesca, KaMo	–	VA/Z 10.1	2CDG120009R0011		0.06	1
Valve Adapter for valves from Honeywell, Reich, Cazzaniga, Landis & Gyr, MNG	–	VA/Z 50.1	2CDG120010R0011		0.05	1
Valve Adapter for valves from Danfoss RA	–	VA/Z 78.1	2CDG120011R0011		0.03	1
Valve Adapter for valves from Heimeier, Herb, Onda, Schlösser (ab 93), Oventrop	–	VA/Z 80.1	2CDG120012R0011		0.06	1



SUG/U 1.1

Split Unit Gateway, FM

The Split Unit Gateway forms the interface between the KNX system and many manufacturers' air conditioners, so-called split units. The device converts the KNX telegrams into infrared commands and transmits them to the split unit. The transmitter of the supplied cable is bonded directly onto the split unit's receiver. The split unit then no longer receives the commands from a remote control. Instead, it can be operated via any KNX sensors or via a visual display system. The device is put into operation with the ETS, and a free ETS app is available to select the split unit model. Auxiliary voltage is not required.

Description	Mod. width	Order details		Price	Weight	Pack
		Type code	Order code	1 piece	1 piece	unit
				€	kg	pc.
	–	SUG/U 1.1	2CDG110207R0011		0.02	1

ABB i-bus® KNX

Heating, Ventilation and Air Conditioning

	Fan Coil Controller				
	FCC/S 1.1.1.1	FCC/S 1.1.2.1	FCC/S 1.2.1.1	FCC/S 1.2.2.1	FCC/S 1.3.1.1
General					
Supply voltage	KNX	KNX	KNX	KNX	KNX
Type of installation	DIN-Rail	DIN-Rail	DIN-Rail	DIN-Rail	DIN-Rail
Module width (18 mm)	6	6	6	6	6
Current consumption, bus	< 12 mA	< 12 mA	< 12 mA	< 12 mA	< 12 mA
Manual operation	–	■	–	■	–
Software functionality					
Integrated room temperature controller (RTC)	■	■	■	■	■
Use in Master/Slave System with room operation units	■	■	■	■	■
Fan outputs					
Number of fans	1	1	1	1	1
Fan type:					
1/2/3 step	■	■	■	■	–
Rated current I _n	5 A	5 A	5 A	5 A	–
Rated voltage U _n (50/60 Hz)	250 V AC	250 V AC	250 V AC	250 V AC	–
Continues Fan (0 ... 10 V)	–	–	–	–	■
Valve outputs					
Electronic 0,5 A	2	2	–	–	–
Analog 0...10 V	–	–	2	2	2
Control individual	■	■	■	■	■
Supported valve types:					
– Thermoelectric valve drive (PWM)	2	2	–	–	–
– Motor-driven valve drive (3-point)	1	1	–	–	–
– Analog valve drive or	–	–	2	2	2
– 6-way valve drive	–	–	1	1	1
Switching contact					
Number of contacts	1	1	1	1	1
Rated current I _n	16 A	16 A	16 A	16 A	16 A
Rated voltage U _n (50/60 Hz)	250 V AC	250 V AC	250 V AC	250 V AC	250 V AC
Inputs					
Number of inputs	4	4	4	4	4
Supported sensors:					
– Temperature sensor	■	■	■	■	■
– Dew Point sensor	■	■	■	■	■
– Level sensor	■	■	■	■	■
– Binary signal input	■	■	■	■	■
– Analog room control unit (SAR/A or SAF/A)	1	1	1	1	1
Fan Coil Unit type					
2 pipe					
Heating	■	■	■	■	■
Cooling	■	■	■	■	■
Heating/Cooling	■	■	■	■	■
4 pipe					
Heating/Cooling	■	■	■	■	■
Commissioning and diagnostic function					
Control and diagnosis via ABB i-bus® Tool	■	■	■	■	■

■ = Function is supported

– = Function is not supported

Fan Coil Controller				
	FCC/S 1.3.2.1	FCC/S 1.4.1.1	FCC/S 1.5.1.1	FCC/S 1.5.2.1
General				
Supply voltage	KNX	KNX	KNX	KNX
Type of installation	DIN-Rail	DIN-Rail	DIN-Rail	DIN-Rail
Module width (18 mm)	6	6	6	6
Current consumption, bus	< 12 mA	< 12 mA	< 12 mA	< 12 mA
Manual operation	■	-	-	■
Software functionality				
Integrated room temperature controller (RTC)	■	■	■	■
Use in Master/Slave System with room operation units	■	■	■	■
Fan outputs				
Number of fans	1	1	1	1
Fan type:				
1/2/3 step	-	■	-	-
Rated current I _n	-	5 A	-	-
Rated voltage U _n (50/60 Hz)	-	250 V AC	-	-
Continues Fan (0 ... 10 V)	■	-	■	■
Valve outputs				
Electronic 0,5 A	-	1	2	2
Analog 0...10 V	2	-	-	-
Control individual	■	■	■	■
Supported valve types:				
- Thermoelectric valve drive (PWM)	-	1	2	2
- Motor-driven valve drive (3-point)	-	-	1	1
- Analog valve drive or	2	-	-	-
- 6-way valve drive	1	-	-	-
Switching contact				
Number of contacts	1	-	1	1
Rated current I _n	16 A	-	16 A	16 A
Rated voltage U _n (50/60 Hz)	250 V AC	-	250 V AC	250 V AC
Inputs				
Number of inputs	4	4	4	4
Supported sensors:				
- Temperature sensor	■	■	■	■
- Dew Point sensor	■	■	■	■
- Level sensor	■	■	■	■
- Binary signal input	■	■	■	■
- Analog room control unit (SAR/A or SAF/A)	1	1	1	1
Fan Coil Unit type				
2 pipe				
Heating	■	■	■	■
Cooling	■	■	■	■
Heating/Cooling	■	■	■	■
4 pipe				
Heating/Cooling	■	-	■	■
Commissioning and diagnostic function				
Control and diagnosis via ABB i-bus® Tool	■	■	■	■

■ = Function is supported

- = Function is not supported

ABB i-bus® KNX

Heating, Ventilation and Air Conditioning

	Blower Actuators	
	FCL/S 1.6.1.1	FCL/S 2.6.1.1
General		
Supply voltage	KNX	KNX
Type of installation	DIN-Rail	DIN-Rail
Module width (18 mm)	4	6
Current consumption, bus	< 12 mA	< 12 mA
Manual operation	–	–
Fan outputs		
Number of fans	1	2*
Supported fan types:		
– 1/2/3 step or	■	■
– 3 individual contacts	–	–
Rated current I _n	6 A	6 A
Rated voltage U _n	250/440 V AC (50/60 Hz)	250/440 V AC (50/60 Hz)
Valve outputs		
Electronic 0.5 A	–	–
Analog 0...10 V	–	–
Control individual	–	–
Supported valve types:		
– Thermoelectric valve drive (PWM)	–	–
– Motor-driven valve drive (3-point)	–	–
– Analog valve drive	–	–
Valve type can be mixed	–	–
Switching contact		
Number of contacts	1	2 (5)*
Rated current I _n	6 A	6 A
Rated voltage U _n	250/440 V AC (50/60 Hz)	250/440 V AC (50/60 Hz)
Inputs		
Number of inputs	–	–
Supported sensors:		
– Switch sensor	–	–
– Value/forced operation	–	–
– Temperature sensor	–	–
Fan Coil Unit type		
2 pipe		
Heating	–	–
Cooling	–	–
Heating/Cooling	–	–
4 pipe		
Heating/Cooling	–	–
Various		
Parallel operation	–	–
Commissioning and diagnostic function		
Control and diagnosis via ABB i-bus® Tool	–	–

■ = Function is supported

– = Function is not supported

* = Second fan output can be used as 3 switch outputs



FCC/S 1.1.1.1

Fan Coil Controller, 2 x PWM, 3-stage, MDRC

For the control of fan coil units. Via two electronic outputs, two thermoelectric or one motor-driven valve drive can be controlled for heating and cooling. For the fan control the device features three relay outputs. A relay output switches an additional load of up to 16 A, such as auxiliary heating. Over 4 inputs the room status can be detected and monitored (Use for window contact, dew point sensor, level sensor or temperature sensor). Also it is possible to connect one analog room control unit (SAR/A or SAF/A) to the inputs of the device.

The device has an integrated room temperature controller for the control of the room temperature, which can be used directly to control the outputs of the device. The FCC/S 1.1.2.1 features an easy to use manual operation.

Both devices support the ABB i-bus® Tool for advanced diagnosis and improved commissioning.

Description	Mod. width	Order details		Price	Weight	Pack unit
		Type code	Order code	1 piece	1 piece	
				€	kg	pc.
	6	FCC/S 1.1.1.1	2CDG110210R0011		0.28	1
Manual Operation	6	FCC/S 1.1.2.1	2CDG110211R0011		0.285	1



FCC/S 1.2.2.1

Fan Coil Controller, 2 x 0-10 V, 3-stage, MDRC

For the control of fan coil units. Via two analog outputs, two analog valves or one 6-way valve drive can be controlled for heating and cooling. For the fan control the device features three relay outputs. A relay output switches an additional load of up to 16 A, such as auxiliary heating. Over 4 inputs the room status can be detected and monitored (Use for window contact, dew point sensor, level sensor or temperature sensor). Also it is possible to connect one analog room control unit (SAR/A or SAF/A) to the inputs of the device. The device has an integrated room temperature controller for the control of the room temperature, which can be used directly to control the outputs of the device. The FCC/S 1.2.2.1 features an easy to use manual operation.

Both devices support the ABB i-bus® Tool for advanced diagnosis and improved commissioning.

Description	Mod. width	Order details		Price	Weight	Pack unit
		Type code	Order code	1 piece	1 piece	
				€	kg	pc.
	6	FCC/S 1.2.1.1	2CDG110212R0011		0.23	1
Manual Operation	6	FCC/S 1.2.2.1	2CDG110213R0011		0.235	1

ABB i-bus® KNX

Heating, Ventilation and Air Conditioning



FCC/S 1.3.1.1

Fan Coil Controller, 3 x 0-10 V, MDRC

For the control of fan coil units. Via two analog outputs, two analog valves or one 6-way valve drive can be controlled for heating and cooling. For the fan control the device features an analog output for the control of a continuous fan. A relay output switches an additional load of up to 16 A, such as auxiliary heating. Over 4 inputs the room status can be detected and monitored (Use for window contact, dew point sensor, level sensor or temperature sensor). Also it is possible to connect one analog room control unit (SAR/A or SAF/A) to the inputs of the device. The device has an integrated room temperature controller for the control of the room temperature, which can be used directly to control the outputs of the device. The FCC/S 1.3.2.1 features an easy to use manual operation.

Both devices support the ABB i-bus® Tool for advanced diagnosis and improved commissioning.

Description	Mod. width	Order details		Price	Weight	Pack
		Type code	Order code	1 piece	1 piece	unit
				€	kg	pc.
	6	FCC/S 1.3.1.1	2CDG110214R0011		0.21	1
Manual Operation	6	FCC/S 1.3.2.1	2CDG110215R0011		0.215	1



FCC/S 1.4.1.1

Fan Coil Controller, PWM, 3-stage, MDRC

For the control of fan coil units. Via one electronic output, a thermoelectric valve drive can be controlled for heating and cooling. For the fan control the device features three relay outputs. Over 4 inputs the room status can be detected and monitored (Use for window contact, dew point sensor, level sensor or temperature sensor). Also it is possible to connect one analog room control unit (SAR/A or SAF/A) to the inputs of the device. The device has an integrated room temperature controller for the control of the room temperature, which can be used directly to control the outputs of the device.

The device supports the ABB i-bus® Tool for advanced diagnosis and improved commissioning.

Description	Mod. width	Order details		Price	Weight	Pack
		Type code	Order code	1 piece	1 piece	unit
				€	kg	pc.
	6	FCC/S 1.4.1.1	2CDG110209R0011		0.215	1



FCC/S 1.5.2.1

Fan Coil Controller, 2 x PWM, 0-10 V, MDRC

For the control of fan coil units. Via two electronic outputs, two thermoelectric or one motor-driven valve drive can be controlled for heating and cooling. For the fan control the device features an analog output for the control of a continuous fan. A relay output switches an additional load of up to 16 A, such as auxiliary heating. Over 4 inputs the room status can be detected and monitored (Use for window contact, dew point sensor, level sensor or temperature sensor). Also it is possible to connect one analog room control unit (SAR/A or SAF/A) to the inputs of the device. The device has an integrated room temperature controller for the control of the room temperature, which can be used directly to control the outputs of the device. The FCC/S 1.5.2.1 features an easy to use manual operation.

Both devices support the ABB i-bus® Tool for advanced diagnosis and improved commissioning.

Description	Mod. width	Order details		Price	Weight	Pack
		Type code	Order code	1 piece	1 piece	unit
			€	kg	pc.	
	6	FCC/S 1.5.1.1	2CDG110234R0011		0.21	1
Manual Operation	6	FCC/S 1.5.2.1	2CDG110235R0011		0.215	1



CAR/U 4.1.1.1-71

Room Temperature Controller Fan Coil, 2/4 pipe, On/Off, FM

ABB Caldion® Room Temperature Controller for fan coil units with 2 pipe, 2 pipe with electric heater or 4 pipe system, Flush Mounted, BS standard. Available for standalone function or as KNX device with integrated bus coupling unit. Build in temperature sensor, 2 x binary input for window, dewpoint, condensate alarm. Integrated actuator output control for on/off valve and 3 x fan speed control. Dedicated capacitive touch RTC control button for intuitive control, mode operation and frameless design with large display.

For British standard installation only.

Description	Mod. width	Order details		Price	Weight	Pack
		Type code	Order code	1 piece	1 piece	unit
			€	kg	pc.	
Black	-	CAR/U 4.1.1.1-71	2TAZ740010R2001		0.272	1
White	-	CAR/U 4.1.1.1-84	2TAZ740010R0001		0.272	1



CAR/U 4.2.1.1-71

Room Temperature Controller Fan Coil, 2/4 pipe, 0-10V, FM

ABB Caldion® Room Temperature Controller for fan coil units with 2 pipe, 2 pipe with electric heater or 4 pipe system, Flush Mounted, BS standard. Available for standalone function or as KNX device with integrated bus coupling unit. Build in temperature sensor, 2 x binary input for window, dewpoint, condensate alarm. Integrated actuator output control for 0-10V valve and 3 x fan speed control. Dedicated capacitive touch RTC control button for intuitive control, mode operation and frameless design with large display.

For British standard installation only.

Description	Mod. width	Order details		Price	Weight	Pack
		Type code	Order code	1 piece	1 piece	unit
			€	kg	pc.	
Black	-	CAR/U 4.2.1.1-71	2TAZ741010R2001		0.272	1
White	-	CAR/U 4.2.1.1-84	2TAZ741010R0001		0.272	1

ABB i-bus® KNX

Heating, Ventilation and Air Conditioning



FCL/S 2.6.1.1

Blower Actuator, 6 A, MDRC

Controls one blower or fan with up to three fan speeds via step or changeover control. Furthermore a additional equipment like a damper or valve can be switched by one floating output. The fan speed can be directly chosen, increased and decreased as well as controlled by the control value of a external closed-loop controller.

Description	Mod. width	Order details		Price	Weight	Pack
		Type code	Order code	1 piece	1 piece	unit
				€	kg	pc.
1-fold	4	FCL/S 1.6.1.1	2CDG110163R0011		0.18	1
2-fold	6	FCL/S 2.6.1.1	2CDG110164R0011		0.26	1



SAF/A 1.0.1-24

Room Temperature and Fan Coil Control Element, SM

The control element is used in conjunction with the FCC/S Fan Coil Controller or the VC/S Valve Controller for temperature adjustment, measurement and fan speed adjustment.

Description	Mod. width	Order details		Price	Weight	Pack
		Type code	Order code	1 piece	1 piece	unit
				€	kg	pc.
davos/studio white	-	SAF/A 1.0.1-24	2CKA006134A0348			1



SAR/A 1.0.1-24

Room Temperature Control Element, SM

The control element is used in conjunction with the FCC/S Fan Coil Controller or the VC/S Valve Controller for temperature adjustment and measurement.

Description	Mod. width	Order details		Price	Weight	Pack
		Type code	Order code	1 piece	1 piece	unit
				€	kg	pc.
davos/studio white	-	SAR/A 1.0.1-24	2CKA006134A0346			1



6138/11-84-500

Room Thermostat Fan Coil with Display, SM

Sends control values for the room to the Fan Coil Actuators or devices with the respective outputs (e.g. Room Master). The intuitive control operation allows each user to individually set the room temperature and the fan speed. The large LC display can display the actual and target temperatures, the current operating mode as well as the fan speeds. With integrated Bus Coupler.

Description	Mod. width	Order details		Price	Weight	Pack
		Type code	Order code	1 piece	1 piece	unit
				€	kg	pc.
aluminium silver	-	6138/11-83-500	2CKA006138A0005		0.092	1
davos/studio white	-	6138/11-84-500	2CKA006138A0003		0.092	1



LGS/A 1.2

Air Quality Sensor with Room Temperature Controller, SM

For the control and measuring of the room air quality and temperature. Accurately measures the CO₂ concentration (390...10.000 ppm), humidity (0...100 %) and temperature (0...50 °C) in a room and sends the values on the bus. By using the integrated thresholds the measured values can be monitored. With the integrated controller it is possible to control the room temperature and HVAC actuators. With integrated Bus Coupler.

Description	Mod. width	Order details		Price	Weight	Pack unit
		Type code	Order code	1 piece	1 piece	
				€	kg	pc.
	-	LGS/A 1.2	2CDG120059R0011		0.06	1



AC/S 1.1.1

Application Controller, MDRC

The AC/S Application Controller has predefined Automation Modules for a holistic HVAC Automation Solution from Central HVAC to Room Automation. For example Schedule, Set Point Calculation, Heat Curve Calculation, Data Logging and Device Monitoring. Furthermore own Automation Modules can be created by a graphical Logic Editor. By a web based User Interface the whole system can be monitored and managed.

The AC/S 1.2.1 has additional a built in bidirectional KNX-BACnet/IP Gateway (Server) for data exchange with superordinate Building Management Systems.

The Engineering is done completely by the ETS. An additional external Software is not required. The device has a KNX TP port.

Description	Mod. width	Order details		Price	Weight	Pack unit
		Type code	Order code	1 piece	1 piece	
				€	kg	pc.
Basic	4	AC/S 1.1.1	2CDG110205R0011		0.19	1
BACnet	4	AC/S 1.2.1	2CDG110206R0011		0.19	1

ABB i-bus® KNX

Heating, Ventilation and Air Conditioning

	Heating/Cooling Circuit Controller HCC/S 2.1.x.1	Heating/Cooling Circuit Controller HCC/S 2.2.x.1
General		
Supply voltage	KNX	KNX
Type of installation	DIN-Rail	DIN-Rail
Module width (17.5 mm)	8	8
Number of channels	2	2
Outputs		
3- way mixing valve control type	0 ... 10 V DC	3 – Point
Valve outputs per channel	1	1
Pump control output per channel	1 (5 A)	1 (5 A)
Inputs		
Input for flow temperature measurement per channel	1	1
Input for return flow temperature measurement per channel	1	1
Inputs for pump status monitoring (pump status, pump failure, pump repair mode) per channel	3	3
Manual operation		
Manual operation	HCC/S 2.1.2.1	HCC/S 2.2.2.1
Software functionality		
Integrated temperature controller for heating or cooling distribution circuits	■	■
Forced operation	■	■
Cyclical monitoring of input values	■	■
Flow temperature limitation	■	■
Safety shutdown temperature	■	■
Manual valve overwrite	■	■
Valve purge	■	■
Manual pump overwrite	■	■
Pump control in dependence of control value	■	■
Channel bundling for double pump systems	■	■

■ = Function is supported

– = Function is not supported



HCC/S 2.1.2.1

Heating/Cooling Circuit Controller, 2-fold, 0-10 V, MDRC

For the control of heating or cooling circuits. The device has 2 channels, each with an analog output to control the mixing valve (0...10 V) of a heating or cooling circuit as well as a relay output (5 A) to switch the pump of the circuit. Via 3 binary inputs it is possible to monitor the status of the pump (via potential free contacts) and integrate these feedback into the control of the pump. The flow and return flow temperature are measured and used for the calculation of the control value for the valve output in the integrated controller. The set point temperature is received via the KNX bus. By bundling both channels of the device it is also possible to use it for double pump systems.

Description	Mod. width	Order details		Price	Weight	Pack
		Type code	Order code	1 piece	1 piece	unit
	6	HCC/S 2.1.1.1	2CDG110218R0011	€	kg	pc.
	6	HCC/S 2.1.1.1	2CDG110218R0011		0.28	1
Manual Operation	6	HCC/S 2.1.2.1	2CDG110219R0011		0.285	1



HCC/S 2.2.1.1

Heating/Cooling Circuit Controller, 2-fold, 3-point, MDRC

For the control of heating or cooling circuits. The device has 2 channels, each with two electronic outputs to control a motor-driven mixing valve (3-Point) of a heating or cooling circuit as well as a relay output (5 A) to switch the pump of the circuit. Via 3 binary inputs it is possible to monitor the status of the pump (via potential free contacts) and integrate these feedback into the control of the pump. The flow and return flow temperature are measured and used for the calculation of the control value for the valve output in the integrated controller. The set point temperature is received via the KNX bus. By bundling both channels of the device it is also possible to use it for double pump systems.

Description	Mod. width	Order details		Price	Weight	Pack
		Type code	Order code	1 piece	1 piece	unit
	6	HCC/S 2.2.1.1	2CDG110220R0011	€	kg	pc.
	6	HCC/S 2.2.1.1	2CDG110220R0011		0.285	1
Manual Operation	6	HCC/S 2.2.2.1	2CDG110221R0011		0.29	1

ABB i-bus® KNX

Heating, Ventilation and Air Conditioning



BCI/S 1.1.1

Boiler/Chiller Interface, 1-fold, MDRC

As interface between the KNX system and a heat generator or chiller. Via an analog output (0...10 V) the set point or set point adjustment temperature can be transmitted to the heat generator/chiller. The set point itself is received via KNX. Via two binary inputs the device can monitor the status of the heat generator/chiller (via potential free contacts) and send it on the KNX bus. A relay output (5 A) is included to switch or enable/disable the heat generator/chiller. With an additional relay output (5 A) the pump of the heat generator/chiller can be switched on and off. Via 3 binary inputs it is possible to monitor the status of the pump (via potential free contacts) and integrate these feedback into the control of the pump. The device supports the ABB i-bus® Tool for advanced diagnosis and improved commissioning.

Description	Mod. width	Order details		Price	Weight	Pack
		Type code	Order code	1 piece	1 piece	unit
				€	kg	pc.
	6	BCI/S 1.1.1	2CDG110222R0011		0.21	1



PM5630-2ETH

AC500 Programmable Logic Controller PM5630

Powerful freely programmable KNX Building Automation Controller with flexible expandable In- and Output Modules. Automation programs based on the globally standardized IEC 61131 programming languages can be executed. Both the graphical and textual programming languages are supported. The programming software ABB Automation Builder based on the established Codesys software enables the easy creation and reuse of automation programs as well as the integration of software libraries. The ABB Automation Builder is integrated with the ETS through an ETS app.

Up to 1000 KNX group objects can be used in the automation program. The KNX relevant settings such as physical address, linking of the controller group objects with group addresses and the KNX sending conditions are set in the ETS and can also be changed at any time without ABB Automation Builder.

The building automation controller has two Ethernet network interfaces. The use is flexible adjustable. In addition to KNXnet/IP communication, these can also be used for other protocols and functions. Among other things, for Modbus TCP and a web server with a freely customizable web interface for display and operation of the system.

The controller has a built-in display, an RS-232/485 interface for i. a. Modbus. The internal clock and data variables can be buffered by a battery. The internal memory of 8 MB can be extended by the memory card slot.

For a complete product the CPU module PM5630-2ETH as well as the Terminal Base TB5600-2ETH are required. To be able to connect the PLC with KNX the KNX Runtime License is required additionally.



TB5600-2ETH

Description	Mod. width	Order details		Price	Weight	Pack
		Type code	Order code	1 piece	1 piece	unit
				€	kg	pc.
AC500 Programmable Logic Controller PM5630	–	PM5630-2ETH	1SAP131000R0278		0.16	1
AC500 Terminal Base TB5600-2ETH		TB5600-2ETH	1SAP110300R0278		0.20	1
AC500 V3 KNX IP Runtime License		PS5604-KNX	1SAP195800R0101		0.01	1



DM200-TOOL

License Automation Builder

License for the engineering software Automation Builder for AC500 PLCs:

This license is valid for a single computer and allows the programming of any number of AC500 PLCs.

Description	Mod. width	Order details		Price	Weight	Pack
		Type code	Order code	1 piece	1 piece	unit
				€	kg	pc.
	-	DM200-TOOL	1SAS010000R0102		0.01	1



DI572

Digital Input Module, 16 DI 240 V AC

Extension module for the AC500 PLC with 16 digital inputs for 100 - 240 V AC. Connection of the cables via pluggable spring terminals.

Terminals (9 + 11 springs) must be ordered additionally.

Description	Mod. width	Order details		Price	Weight	Pack
		Type code	Order code	1 piece	1 piece	unit
				€	kg	pc.
Digital Input Module, 16 DI 240 V AC	-	DI572	1SAP230500R0000		0.14	1
TA565-11/L444711:S500, Terminal block, 11 springs		TA565-11	1TNE968901R3106		0.02	6
TA565-9/L444709:S500, Terminal block, 9 springs		TA565-9	1TNE968901R3105		0.02	6



DC562

Digital Input/Output Module 16DC: 24 V DC/0.5 A

Extension module for the AC500 PLC with 16 switchable digital inputs or outputs for 24 V DC. The electronic transistor outputs switch 0.5 A. Connection of the cables via pluggable spring terminals.

Terminals (9 + 11 springs) must be ordered additionally.

Description	Mod. width	Order details		Price	Weight	Pack
		Type code	Order code	1 piece	1 piece	unit
				€	kg	pc.
Digital Input/Output Module 16DC: 24 V DC/0.5 A	-	DC562	1SAP231900R0000		0.22	1
TA565-11/L444711:S500, Terminal block, 11 springs		TA565-11	1TNE968901R3106		0.02	6
TA565-9/L444709:S500, Terminal block, 9 springs		TA565-9	1TNE968901R3105		0.02	6

ABB i-bus® KNX

Heating, Ventilation and Air Conditioning



DX571

Digital Input/Output Module, 8 Digital Inputs/8 Digital Outputs - Relay

Extension module for the AC500 PLC with 8 digital inputs and 8 digital outputs. The digital inputs process 24 V DC signals. The relay outputs switch a maximum of 2 A at 24 V DC and a maximum of 1.5 A at 120/240 V AC. Connection of the cables via pluggable spring terminals. Terminals (9 + 11 springs) must be ordered additionally.

Description	Mod. width	Order details		Price	Weight	Pack
		Type code	Order code	1 piece	1 piece	unit
				€	kg	pc.
Digital Input/Output Module, 8 Digital Inputs/8 Digital Outputs - Relay	–	DX571	1TNE968902R2302		0.24	1
TA565-11/L444711:S500, Terminal block, 11 springs		TA565-11	1TNE968901R3106		0.02	6
TA565-9/L444709:S500, Terminal block, 9 springs		TA565-9	1TNE968901R3105		0.02	6



DO572

Digital Output Module, 8 Digital Outputs, Triac, 0.3 A

Extension module for the BAC/S Building Automation Controller KNX with 8 digital outputs. The digital triac outputs switch a maximum of 0.3 A at 120/240 V AC. Connection of the cables via pluggable spring terminals. Terminals (9 + 11 springs) must be ordered additionally.

Description	Mod. width	Order details		Price	Weight	Pack
		Type code	Order code	1 piece	1 piece	unit
				€	kg	pc.
Digital Output Module, 8 Digital Outputs, Triac, 0.3 A	–	DO572	1TNE968902R2203		0.16	1
TA565-11/L444711:S500, Terminal block, 11 springs		TA565-11	1TNE968901R3106		0.02	6
TA565-9/L444709:S500, Terminal block, 9 springs		TA565-9	1TNE968901R3105		0.02	6



AX561

Analog Input/Output Module, 4 Analog Inputs/2 Analog Outputs U/I

Extension module for the BAC/S Building Automation Controller KNX with 4 analog inputs and 2 analog outputs. The inputs and outputs support voltage signals from 0 V ... + 10 V, 0 V ... + 5 V, -2.5 V ... + 2.5 V and -5 V ... + 5 V as well as current signals of 0 mA ... 20 mA and 4 mA ... 20 mA. Connection of the cables via pluggable spring terminals. Terminals (9 + 11 springs) must be ordered additionally.

Description	Mod. width	Order details		Price	Weight	Pack
		Type code	Order code	1 piece	1 piece	unit
				€	kg	pc.
Analog Input/Output Module, 4 Analog Inputs/2 Analog Outputs U/I	–	AX561	1TNE968902R1301		0.23	1
TA565-11/L444711:S500, Terminal block, 11 springs		TA565-11	1TNE968901R3106		0.02	6
TA565-9/L444709:S500, Terminal block, 9 springs		TA565-9	1TNE968901R3105		0.02	6



AI562

Analog Input Module, 2 Analog Inputs

Extension module for the BAC/S Building Automation Controller KNX with 2 analog inputs for temperature sensors. Temperature sensors of type Pt100, Pt1000, Ni100, Ni1000 and 150 Ohm, 300 Ohm are supported. Connection of the cables via pluggable spring terminals. Terminals (11 springs) must be ordered additionally.

Description	Mod. width	Order details		Price	Weight	Pack unit
		Type code	Order code	1 piece	1 piece	
				€	kg	pc.
Analog Input Module, 2 Analog Inputs	–	AI562	1TNE968902R1102		0.22	1
TA565-11/L444711:S500, Terminal block, 11 springs		TA565-11	1TNE968901R3106		0.02	6

ABB i-bus® KNX

Automation, Logic and Time Control

	Logic Module LM/S 1.1	Application Unit, Logic ABL/S 2.1	Application Unit, Time ABZ/S 2.1	Logic Controller ABA/S 1.2.1
General				
Supply voltage	KNX	KNX	KNX	24 V DC / PoE
Ethernet connection	-	-	-	■
Type of installation	DIN-Rail	DIN-Rail	DIN-Rail	DIN-Rail
Module width (18 mm)	2	2	2	4
Software function				
Logic gates	■	■	-	■
Gate/filter	■	■	-	■
Multiplexer	-	-	-	■
Flip Flop	-	-	-	■
PID Controller	-	-	-	■
Composite function blocks	-	-	-	■
Time delay	■	■	-	■
Staircase lighting/Pulse duration	■	■	-	■
Calculation	□	-	-	■
Min./Max.	■	■	-	■
Comparator/Threshold	■	■	-	■
Format converter	■	-	-	■
Counter	■	-	-	■
Calendar switch program	-	-	■	■
Day routines	-	-	■	■
Week routines	-	-	■	■
Year routines	-	-	■	■
Special days	-	-	■	-
Daylight saving times	-	-	■	-
Telegram multiplier	■	-	■	■
Simulation (offline)	-	-	-	■
Websserver	-	-	-	■
Programming via KNX	■	■	■	■
Programming via Ethernet	-	-	-	■
Max. number of function elements	3	140	30	3000
Monitoring (online)	-	-	-	■

■ = Function is supported

- = Function is not supported

□ = Limited functions



LM/S 1.1

Logic Module, MDRC

Used to solve a varied range of project-specific control tasks and can implement 3 functions simultaneously. The following functions are available for selection: logic gate, filter, time delay, multiplier, min/max value detector, temperature comparator, toggle values, threshold detection, format converter, scenes, increment/decrement values, staircase lighting.

Description	Mod. width	Order details		Price	Weight	Pack
		Type code	Order code	1 piece	1 piece	unit
				€	kg	pc.
	2	LM/S 1.1	GHQ6310080R0111		0.1	1



ABL/S 2.1

Application Unit Logic, MDRC

Allows the compilation of complex logical functions by simply combining different logic elements and gates using a graphical user interface as an ETS plug-in and does not require additional software. 50 logical elements, 50 gates, 30 timer modules and 10 comparators are available.

Description	Mod. width	Order details		Price	Weight	Pack
		Type code	Order code	1 piece	1 piece	unit
				€	kg	pc.
	2	ABL/S 2.1	2CDG110073R0011		0.12	1



ABZ/S 2.1

Application Unit Time, MDRC

It provides a yearly time clock program with 15 daily routines (800 switching events), a weekly schedule and allowance for 100 special days. Additionally, the unit can control up to 300 participants in 30 macro groups, that can be triggered using a single command. In this way, each time controlled switching event can cause a series of actions. The switching times can be modified with the free PZM software without using ETS. PZM Software and additional information on www.abb.com/knx.

Description	Mod. width	Order details		Price	Weight	Pack
		Type code	Order code	1 piece	1 piece	unit
				€	kg	pc.
	2	ABZ/S 2.1	2CDG110072R0011		0.12	1



ABA/S 1.2.1

Logic Controller, MDRC

The device provides extensive logic functions. The logic is defined via a graphic editor integrated in the ETS. Up to 3000 logic gates are possible.

The generated logic can be tested by a simulation function. User-defined function blocks can be created and saved for taking them over into other projects.

The device requires an auxiliary voltage, either 24 V DC or Power over Ethernet (PoE). If timer functions are used the date and time has to be provided via KNX/TP.

Description	Mod. width	Order details		Price	Weight	Pack
		Type code	Order code	1 piece	1 piece	unit
				€	kg	pc.
	4	ABA/S 1.2.1	2CDG110192R0011		0.192	1

ABB i-bus® KNX

Automation, Logic and Time Control



FW/S 8.2.1

Radio Time Switch, 8 Channels, MDRC

The Radio Time Switch sends current time and date on the bus. The time can be optionally received via a DCF or GPS antenna. Furthermore the device can be used to easily adjust the time programs.

The device provides 8 channels. Every channel supplies an independent daily, time and/or yearly program. Additionally, special programs (e.g. for vacation or public holiday days) are possible.

Description	Mod. width	Order details		Price	Weight	Pack
		Type code	Order code	1 piece	1 piece	unit
				€	kg	pc.
	3	FW/S 8.2.1	2CDG120039R0011		0.33	1



FAD/A 1.1

DCF Antenna for Radio Time Switch, SM

For the connection to the Radio Time Switch FW/S 8.2.1. The time signal from the DCF 77 transmitter can be received within a radius of approx. 1000 km around Frankfurt.

Description	Mod. width	Order details		Price	Weight	Pack
		Type code	Order code	1 piece	1 piece	unit
				€	kg	pc.
	-	FAD/A 1.1	2CDG120040R0011		0.17	1



FAG/A 1.2

GPS Antenna for Radio Time Switch, SM

For the connection to the Radio Time Switch FW/S 8.2.1. The device receives time and date via GPS signal which is available worldwide.

Description	Mod. width	Order details		Price	Weight	Pack
		Type code	Order code	1 piece	1 piece	unit
				€	kg	pc.
	-	FAG/A 1.2	2CDG120070R0011		0.09	1



PS/E 2.2

Programming Set OBELISK top2 for Radio Time Switch

The programming set contains a memory card PK/E 2.1 for transferring switching programs to the Radio Time Switch and a USB programming adapter for the memory card. The newest version of the software Obelisk top2 for the creation of switching programs for the Radio Time Switch FW/S 8.2.1 can be downloaded on our website.

Description	Mod. width	Order details		Price	Weight	Pack
		Type code	Order code	1 piece	1 piece	unit
				€	kg	pc.
	-	PS/E 2.2	2CDG120071R0011		0.20	1



PK/E 2.1

Memory Card OBELISK top2 for Radio Time Switch

The memory card can be used for transferring switching programs to Radio Time Switch.

Description	Mod. width	Order details		Price	Weight	Pack
		Type code	Order code	1 piece	1 piece	unit
				€	kg	pc.
	-	PK/E 2.1	2CDG120043R0011		0.02	1



TR/A 1.1

Time Receiver GPS, SM

For the reception and processing of the GPS signal, as well as for brightness and temperature measurement. The sensor measures the brightness and outside temperature and sends them on the KNX bus. Likewise the time, date and geographical coordinates are send to the KNX bus. Additionally the sunrise and sunset times are also send to the bus. With integrated Bus Coupler.

Description	Mod. width	Order details		Price	Weight	Pack
		Type code	Order code	1 piece	1 piece	unit
				€	kg	pc.
	-	TR/A 1.1	2CDG120060R0011		0.09	1

ABB i-bus® KNX

Visualisation, Display and Signalling



UK/S 32.2

Universal I/O Concentrator, 32-fold, MDRC

Used to connect push buttons or signal lamps, e.g. to an operating/display tableau. It has 32 channels which can be freely parameterised as inputs/outputs using the ETS software. The device requires an external 12 or 24 V DC auxiliary power supply, (e. g. NT/S 24.800).

Description	Mod. width	Order details		Price	Weight	Pack
		Type code	Order code	1 piece	1 piece	unit
	4	UK/S 32.2	2CDG110071R0011	€	kg	pc.
					0.18	1

ABB RoomTouch® 5"

As individual as your home



- Up to 30 control elements
- The full hand activates a predefined “coming in” scene or function
- Acoustic and haptic feedback
- Integrated proximity and brightness sensor
- Integrated room temperature controller
- Anti-glare mode for use in dark
- Integrated binary input
- Integrated external temperature sensor input
- Commissioning via ETS5 and DCA tool

The HD IPS touch display can be mounted in landscape format or portrait format for intelligent building control (alignment can be decided on-site)

ABB Smart Touch® 10"

Elegant central control for smart buildings

Freely programmable Touch panel featuring a 10-inch IPS screen with 1280 x 800 resolution that combines smart home and building automation and door communication in one device for residential applications, hotels, and commercial buildings. ABB SmartTouch® 10" offers home control and monitoring of the ABB-free@home®, or ABB i-bus® KNX system and the fully integrated functions of ABB-Welcome.



Control, observe and manage your entire installation on one device: Switching – Dimming – Slider – Blind – RGBW control element – Step switch – Scene switch – Display element – Audio control element – RTC control element – VRV control element and display different values such as energy consumption and production. With scene function, logic functions, presence simulation and time programs. ABB SmartTouch® 10" can also be used as an end device for communication with the ABB-Welcome outdoor stations, and as part of the ABB-Welcome door communication system.

—
01

Functions:

- ABB i-bus® KNX: A total of 450 control elements are displayed on a maximum of 25 pages.
- ABB-free@home®: Twisted pair connection provides a single dashboard page with a maximum of 18 controls. Alternatively, for additional control, connection via wi-fi delivers the same amount of control and features as the ABB-free@home® App Next.
- 80 fault and alarm messages
- 30 logic functions
- 40 timers
- presence simulation for 20 participants
- 10 scene actuators (in total 100 scenes are possible to store)
- 3 object RTCs
- Equipped with a hearing loop for coupling the audio signal into hearing aids
- A single page can have up to 18 touch surfaces

Specifications:

- External power supply: 20-32 V DC (SELV) or via the ABB-Welcome system controller.
- Display size: 25,4 cm (10"): Display resolution: 1280 x 800: Display screen: IPS display
- Dimensions (L x W x D): (180.2 mm x 254.6 mm x 17.5 mm)
- Flush or Surface mounted. Can also be mounted on a desktop stand.
- The flat design slim real metal frame sits almost flush with the wall (14 mm) and is available in 4 colors (stainless steel, graphite, gold and rose gold) and black or white glass.

Busch-ControlTouch®

Smartphones, tablets and smartwatches or PCs turn into a practical remote control, thanks to the Busch-ControlTouch®. It connects the KNX installation with the IP network and controls all KNX functions in the building.



New features:

- Works with Sonos
- RTC integration compatible with ClimaEco
- Background pictures with bubble controls

Device features worth mentioning:

- External access the the KNX system
- Easy creation of individual scenes
- Integrated weekly timer (with astro function)
- Integrated logic editor
- Recording and display of diagrams
- Sonos and Philips Hue connection
- Connection of IP cameras with MJPEG protocol possible
- Integrated rights and user management
- Alarm messages via e-mail and/or push notification
- iOS widget for fast access from the mobile terminal device



The applications for iOS and Android create intuitive operation the same as the PC application. The compact 4 MW DIN rail can be parameterized via the MyBuildings portal, thereby making it completely future-oriented for future system extensions and modifications. In addition: Many useful services (e.g. external access to the KNX system or a notification service) through connection to the MyBuildings portal Cloud are very easy to implement. Whether in a single residential unit, in a large apartment block or at the workplace – the Busch-SmartTouch® intelligently controls the home automation. Either locally or while travelling. With the Busch-SmartTouch® you have complete access at all times.

Busch-VoiceControl® KNX

Control completely by voice

The building of the future recognises the needs of its users. It reacts individually – automatically and without being asked to do so.



—
01 Busch-
VoiceControl® KNX



—
01



- Approved solution for the systems Google Assistant, Amazon Alexa, Apple HomeKit
- Integration of lighting, heating and blind control systems
- All voice commands can be used simultaneously
- Control up to 150 functions
- HomeKit certification allows control of the KNX system from other HomeKit devices, such as the iPad, iPhone and Apple TV

ABB i-bus® KNX

Visualisation, Display and Signalling



6136/27-811-500

ABB RoomTouch® 5", FM

Freely programmable KNX touch display as a control, notification and operation center for e.g. your room. For the display and operation of the following KNX standard functions: switching, dimming, value slider, blind, RGBW LED control, step switch, RTC, scene switch, display element, audio control and Split Unit control. With scene and logic functions and time programs. Displays alerts and malfunctions. Programmable with up to max 30 functions. With a switch input and a temperature sensor input. With a proximity sensor and brightness sensor. It has haptic and acoustic feedback. There is a primary function for entering the room.

External power supply: 20 – 32 V DC (SELV). The freely programmable touch display (5") comes with a HD resolution of 720 x 1280 and a view angle of 160°.

Description	Mod. width	Order details		Price	Weight	Pack
		Type code	Order code	1 piece	1 piece	unit
				€	kg	pc.
white glass	–	RT/U 30.0.1-811	2TMA200050W0007		0.24	1
black glass	–	RT/U 30.0.1-825	2TMA200050B0005		0.24	1



6136/07 UP-500

ABB RoomTouch® Installation Box, FM

For flush mounting and hollow wall panel mounting of the ABB RoomTouch® 5" RT/U30.0.1-8xx. Windproof.

Dimensions flush mounting (H x W x D): 121 mm x 58 mm x 50 mm.

Description	Mod. width	Order details		Price	Weight	Pack
		Type code	Order code	1 piece	1 piece	unit
				€	kg	pc.
box	–	BOX/U 5.1	2TMA200160B0003		0.10	1

ABB i-bus® KNX

Visualisation, Display and Signalling



ST/U10.1.1-811

ABB SmartTouch® 10"

NEW

Freely programmable Touch panel featuring a 10-inch IPS screen with 1280*800 resolution that combines smart home automation and door communication in one device for residential applications, hotels, and commercial buildings. ABB SmartTouch® 10" offers home control and monitoring of the ABB-free@home®, or ABB i-bus®KNX system and the fully integrated functions of ABB-Welcome.

Control, observe and manage your entire installation on one device: Switching – Dimming – Slider – Blind – RGBW control element – Step switch – Scene switch – Display element – Audio control element – RTC control element – VRV control element and display different values such as energy consumption and production. With scene function, logic functions, presence simulation and time programs. ABB SmartTouch® 10" can also be used as an end device for communication with the ABB-Welcome outdoor stations, and as part of the ABB-Welcome door communication system.

Description	Mod. width	Order details		Price 1 piece	Weight 1 piece	Pack unit
		Type code	Order code			
white/stainless	–	ST/U10.1.1-811	2TMA310051W0001		0.793	1
black/stainless	–	ST/U10.1.1-825	2TMA310051B0001		0.793	1
white/graphite	–	ST/U10.2.1-811	2TMA310051W0002		0.953	1
black/graphite	–	ST/U10.2.1-825	2TMA310051B0002		0.953	1
white/satin gold	–	ST/U10.3.1-811	2TMA310051W0003		0.953	1
black/satin gold	–	ST/U10.3.1-825	2TMA310051B0003		0.953	1
white/rose gold	–	ST/U10.4.1-811	2TMA310051W0004		0.953	1
black/rose gold	–	ST/U10.4.1-825	2TMA310051B0004		0.953	1



ST/A10.1-811

Surface Mounting Frame for SmartTouch® 10"

NEW

Surface mounting frame for mounting the ABB SmartTouch 10" ST/U10.x.1-8xx on:

- standard flush mounted wall box VDE & BS
- Already installed flush mounted installation box:
 - 6136/UP
 - 8136/01 UP-500
 - UP-KAST 2
- to be mounted directly on the wall
- to be mounted on the ABB-Welcome table stand

Description	Mod. width	Order details		Price 1 piece	Weight 1 piece	Pack unit
		Type code	Order code			
white	–	ST/A10.1-811	2TMA310161W0001		0.144	1
black	–	ST/A10.1-825	2TMA310161B0001		0.144	1



6136/07-811-500

Busch-SmartTouch® 7", SM**to be discontinued**

Free programmable KNX touch display as a control, notification and operation center for the entire house. Works as a video indoor station with the ABB-Welcome Door Entry System.

During the conversation a picture of the visitor can be taken and stored in the picture memory. For the display and operation of the following KNX standard functions: switching, dimming, slider, blind, RGBW LED control, step switch, RTC, scene switch, display element, audio control. With scene and logic functions, presence simulation and time programs.

Displays alerts and malfunctions. Available with induction loop for connecting to hearing aid devices. Programmable with up to 16 functions per page.

External power supply: 20 – 32 V DC (SELV) or through the ABB-Welcome bus. The freely programmable touch display (7") comes with a resolution of 1024 x 600.

Description	Mod. width	Order details		Price	Weight	Pack
		Type code	Order code	1 piece	1 piece	unit
				€	kg	pc.
white glass	–	6136/07-811-500	2CKA006136A0205		0.94	1
black	–	6136/07-825-500	2CKA006136A0206		0.94	1



6136/27-811-500

Surface Mounting Frame for SmartTouch 7"**to be discontinued**

Surface mounting frame for mounting the Busch-SmartTouch 7" 6136/07-8xx-500 on:

- standard flush mounted wall box VDE & BS
- flush mounted installation box (6136/UP) or
- to be mounted directly on the wall
- to be mounted on the ABB-Welcome table stand

Description	Mod. width	Order details		Price	Weight	Pack
		Type code	Order code	1 piece	1 piece	unit
				€	kg	pc.
white	–	6136/27-811-500	2CKA006136A0209		0.358	1
black	–	6136/27-825-500	2CKA006136A0210		0.358	1

ABB i-bus® KNX

Visualisation, Display and Signalling



6136/07 UP-500

Busch-SmartTouch Installation Box, FM

For flush mounting and hollow panel mounting of the Busch-SmartTouch 7" 6136/07-8xx-500 and Busch-SmartTouch 10" ST/U10.x.1-8xx. Windproof.

Dimensions flush mounting (H x W x D): 152 mm x 235 mm x 60 mm.

Dimensions hollow wall (H x W x D): 146 mm x 227 mm x 50 mm.

Description	Mod. width	Order details		Price	Weight	Pack unit
		Type code	Order code	1 piece	1 piece	
				€	kg	pc.
	-	6136/07 UP-500	2CKA006136A0212		0.549	1

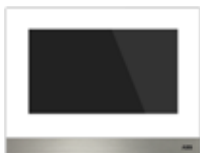

H8236-5W

IP touch 7 LAN / LAN

With integrated induction Loop. Can be used for ABB Welcome IP, ABB i-bus® KNX,

ABB-free@home. For ABB-Welcome IP support direct connection to ABB-Welcome App.

For ABB-free@home: Up to 4 pages and each with up to 16 control elements. Total 64 control

frames. For ABB i-bus® KNX: Up to 8 pages and each with up to 16 control elements. Total

64 control frames. Flush mountable. Power Supply over PoE, local power supply or plug-in

power supply (53011PS).

Description	Mod. width	Order details		Price	Weight	Pack unit
		Type code	Order code	1 piece	1 piece	
				€	kg	pc.
white	-	H8236-5W	2TMA130050W0067		0.4875	1
black	-	H8236-5B	2TMA130050B0067		0.4875	1



H8236-4B

IP touch 7 LAN / Wifi

With integrated induction Loop. Can be used for ABB Welcome IP, ABB i-bus® KNX,

ABB-free@home. For ABB-Welcome IP support direct connection to ABB-Welcome App.

For ABB-free@home: Up to 4 pages and each with up to 16 control elements. Total 64 control

frames. For ABB i-bus® KNX: Up to 8 pages and each with up to 16 control elements. Total

64 control frames. Surface/flush/desktop mountable. Power Supply over PoE, local power

supply or plug-in power supply (53011PS).

Description	Mod. width	Order details		Price	Weight	Pack unit
		Type code	Order code	1 piece	1 piece	
				€	kg	pc.
white	-	H8236-4W	2TMA130050W0065		0.4875	1
black	-	H8236-4B	2TMA130050B0065		0.4875	1



42361S-W-03

Surface-mounted box for IP touch 7

Mounting of IP touch 7" panel on the wall.

- For surface-mounted installation of indoor station.

- The product is packed with accessories to ensure qualified installation.



42361S-B-03

Description	Mod. width	Order details		Price	Weight	Pack unit
		Type code	Order code	1 piece	1 piece	
				€	kg	pc.
white	-	42361S-W-03	2TMA130160W0021		0.210	1
black	-	42361S-B-03	2TMA130160B0089		0.210	1



H8237-5W

IP touch 10 LAN / LAN

HD resolution display (1280x800px). With integrated induction Loop. Can be used for ABB Welcome IP, ABB i-bus® KNX, ABB-free@home. For ABB-Welcome IP support direct connection to ABB-Welcome App. For ABB-free@home: Up to 4 pages and each with up to 25 control elements. Total 100 control frames. For ABB i-bus® KNX: Up to 8 pages and each with up to 25 control elements. Total 100 control frames. Flush mountable. Power Supply over PoE, local power supply or plug-in power supply (53011PS).

Description	Mod. width	Order details		Price	Weight	Pack
		Type code	Order code	1 piece	1 piece	unit
				€	kg	pc.
white - stainless steel end strip	-	H8237-5W	2TMA130050W0055		1.044	1
black - stainless steel end strip		H8237-5B	2TMA130050B0055		1.044	1



H8237-4B

IP touch 10 LAN / Wifi

HD resolution display (1280x800px). With integrated induction Loop. Can be used for ABB Welcome IP, ABB i-bus® KNX, ABB-free@home. For ABB-Welcome IP support direct connection to ABB-Welcome App. For ABB-free@home: Up to 4 pages and each with up to 25 control elements. Total 100 control frames. For ABB i-bus® KNX: Up to 8 pages and each with up to 25 control elements. Total 100 control frames. Surface/flush/desktop mountable. Power Supply over PoE, local power supply or plug-in power supply (53011PS).

Description	Mod. width	Order details		Price	Weight	Pack
		Type code	Order code	1 piece	1 piece	unit
				€	kg	pc.
white - stainless steel end strip	-	H8237-4W	2TMA130050W0054		1.044	1
black - stainless steel end strip		H8237-4B	2TMA130050B0054		1.044	1



42371S-W

Surface-mounted box for IP touch 10

Mounting of IP touch 10 " panel on the wall.

- For surface-mounted installation of indoor station.
- The product is packed with accessories to ensure qualified installation.

Description	Mod. width	Order details		Price	Weight	Pack
		Type code	Order code	1 piece	1 piece	unit
				€	kg	pc.
white	-	42371S-W	2TMA130161W0001		0.221	1
black	-	42371S-B	2TMA130161B0001		0.221	1

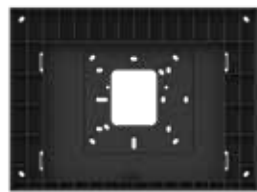

42371S-B

ABB i-bus® KNX

Visualisation, Display and Signalling



42361F

Flush-mounting box for IP touch 7 & 10

Flush mounted box & pre-installation box for IP touch 7 & IP touch 10 LAN/Wifi.

Description	Mod. width	Order details		Price	Weight	Pack
		Type code	Order code	1 piece	1 piece	unit
				€	kg	pc.
black	-	42361F	2TMA130160B0132		0.263	1



53011PS

Plug-in power supply 24 V DC

Plug-in power supply 24 V DC.

Description	Mod. width	Order details		Price	Weight	Pack
		Type code	Order code	1 piece	1 piece	unit
				€	kg	pc.
white	-	53011PS-03	2TMA130160W0029		0.13	1



CT/S 2.1

Busch-ControlTouch® 2, MDRC

Busch-ControlTouch® is a visualisation server for mobile end devices (iOS and Android) and Window computers. Not only for visualise and control your complete KNX installation but also:

- Sonos Bridge with a complete integration of the Sonos API (Works with Sonos) (NEW)
- Can be used as a Bridge between KNX and Philips Hue
- Visualisation of your IP camera's, with support of pan, till and zoom
- Unlimited time programs and scenes and they can be edited by the end user
- Integrate Webpages into your design for maybe weather information or traffic information
- Alarm messages can be sent as email or as a push notification (including a snapshot of an IP camera) but can also be heard on your Sonos System (NEW)
- Can be used as a UPnP bridge, so you can control e.g. your UPnP enabled Receiver via KNX
- Statistics and charts support with 5 period types (hour, day, week, month, year)
- Unrestricted personal profiles with an unlimited number of pages and controls
- Easy to use presence simulation, that can be edit by the end customer and with no limitation of participants
- Visualisation functions: dimmer, RGB(W) control, switch, blind and shutter, heating/cooling, air conditioning, scenes, button row (max. 6 buttons), IP camera, status display, value transmitter, Sonos control, and UPnP control
- Has a flexible and unrestricted Script Editor for more complex logical functions based on LUA (NEW)
- Automatic cloud backups including scenes, time programs and presence simulation data (NEW)
- Complete commissioning is online and live. You can do it from everywhere and you don't need to drive to the customer
- First commissioning with Wizard support (NEW)
- Loading the software into the device can be done without Internet
- Device has a direct KNX interface or can communicate via an IP Interface via the bus
- Visualisation as a list view and/or with background pictures with round, rectangle or transparent controls (NEW)
- Secured remote access via our Cloud solution (For this function, you pay a monthly fee)
- Functional extensions and updates via firmware and software updates.

Security:

This device supports extensive security options to protect your installation and privacy. All communication between the app your installation and our cloud is encrypted and always based on the highest possible standards. The communication between the different parts always requires a username and password. The end user can also protect pages with a pin code, Touch ID or Face ID. Additionally end users can set up local users with access rights to shield certain parts of the home installation or allow them access only to specific parts.

External power supply: 10-36 V DC (SELV)

Control element: freely programmable touch surfaces

Bus voltage: 24 V

Protection class (Device): IP 20

Temperature range (Device): 0 °C to 70 °C

Dimensions: (L x W x D): 90 mm x 72 mm x 60 mm, Module width: 4 MW

Description	Mod. width	Order details		Price	Weight	Pack
		Type code	Order code	1 piece	1 piece	unit
	4	CT/S 2.1	2CKA006136A0218	€	kg	pc.
				0.254		1

ABB i-bus® KNX

Visualisation, Display and Signalling



VCO/S 150.2

Busch-VoiceControl® 2, MDRC

A certified voice control gateway for the combination of a KNX system with a voice control system. Acts as a gateway and guarantees that you can operate the KNX components in a house and query their status using Apple, Amazon and Google devices. This component makes it possible to operate the lighting, blind or room temperature controller using simple voice control. Up to 150 functions can be used. Busch-VoiceControl® is an official certified HomeKit accessory. Complete web-based commissioning. Compatible with ABB i-bus® KNX. External power supply: 10-36 V DC (SELV).

Description	Mod. width	Order details		Price	Weight	Pack
		Type code	Order code	1 piece	1 piece	unit
				€	kg	pc.
	4	VCO/S 150.2	2CKA006136A0220		0.254	1



CP-D 24/2.5

Power Supply Unit, 24 V DC, 2.5 A

For Busch-SmartTouch® 7" 6136/07-8xx-500, Busch-priOn® Power Bus Coupler 6120/13-500 and Busch-ControlTouch®2 CT/S 2.1.

Description	Mod. width	Order details		Price	Weight	Pack
		Type code	Order code	1 piece	1 piece	unit
				€	kg	pc.
	-	CP-D 24/2.5	2CDG120037R0011		0.252	1

ABB i-bus® KNX

Energy Management

ABB offers various solutions for decentral energy measurement on the basis of the KNX standard.

Version 1

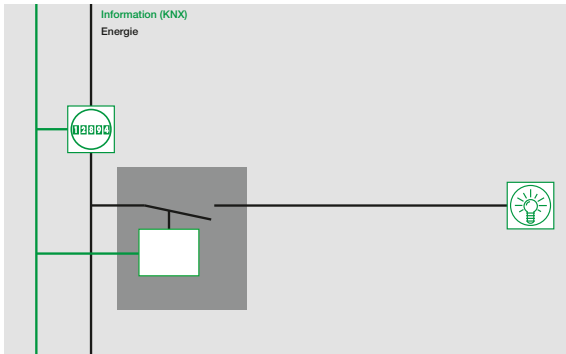

Electronic energy meters make the current energy values available on the KNX bus system in conjunction with a KNX interface. The measured data can be intermediately stored, evaluated and visualized from here.



Version 2

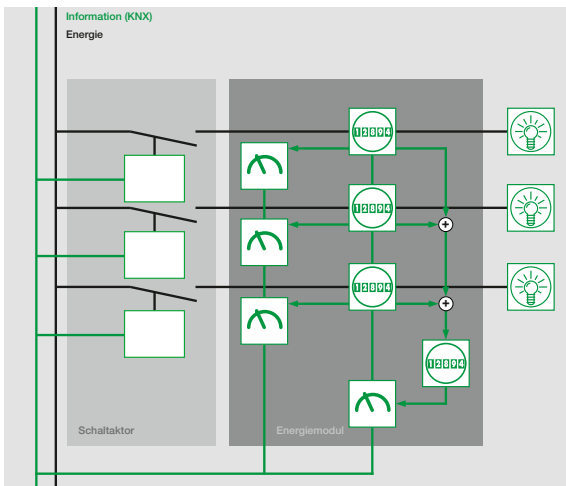

The Energy Module can record the energy consumption for the individual devices. It is used particularly when upgrading existing KNX systems and wherever energy measurement is required without switch functions. It facilitates a detailed and transparent insight into the energy consumption of a building. The current meter values can be sent and evaluated.



Version 3

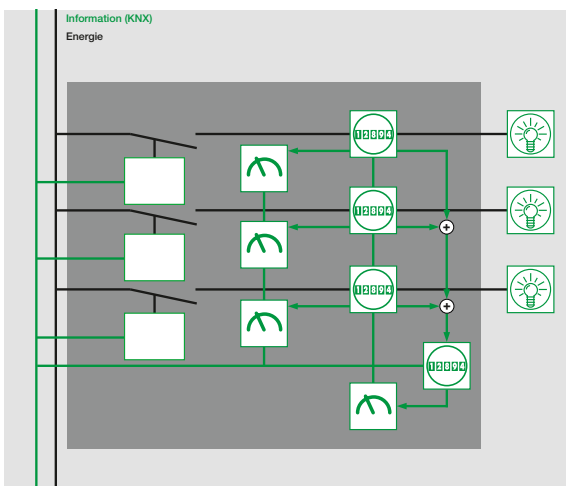

The Energy Actuator facilitates control of the connected consumer loads via the ABB i-bus® KNX. For each of the three switch channels, the individual consumption can be measured in the same way as for the Energy Module. For every channel, the proven functionality of the ABB i-bus® KNX Switch Actuators are available.



ABB i-bus® KNX

Energy Management

	Energy Module EM/S 3.16.1	Energy Actuator SE/S 3.16.1	Meter Interface Module ZS/S 1.1 ¹⁾
General			
Supply voltage	KNX	KNX	KNX
Type of installation	DIN-Rail	DIN-Rail	DIN-Rail
Module width (18 mm)	4	4	2
Number of channels	3	3	–
Rated current I _n	16/20 A	16/20 A AX (C-Load)	–
Measuring range Current	0.025...20 A	0.025...20 A	Depending on meter connected ²⁾
Measuring range Voltage	95...265 V	95...265 V	Depending on meter connected ²⁾
Measuring range Frequency	45...65 Hz	45...65 Hz	50/60 Hz ± 5 %
Measurement values			
E – Active energy [kWh]	■	■	■
U – Voltage [V]	■	■	■
I – Current [A]	■	■	■
F – Frequency [Hz]	■	■	■
P – Active power [W]	■	■	■
Q – Reactive power [var]	–	–	■
S – Apparent power [VA]	■	■	■
PF – Power factor	■	■	■
CF – Crest factor	■	■	–
General functions			
Function Switch	–	■	–
Function Time	–	■	–
Function Scene	–	■	–
Function Logic	–	■	–
Function Priority	–	■	–
Load control with Energy Actuators as Master (up to ten SE/S 3.16.1 as slaves)	■	■	–
Load control as Slave	–	■	–
Sending delay (for value request)	–	–	■
Commissioning and diagnostic function			
Control and diagnosis via ABB i-bus® Tool	■	■	–

■ = Function is supported

– = Function is not supported

1) = In combination with ABB Energy Meter A and B series

2) = See also Electricity Meters Overview



SE/S 3.16.1

Energy Actuator, 3-fold, 16/20 AX, MDRC

Records the energy consumption of the connected electrical loads in the load circuit. Various electrical variables can be monitored and load peaks can be limited by simple load control. The 3 output channels can be manually operated and display the current switching state. The Energy Actuator can switch resistive, inductive and capacitive loads. The switching capacity corresponds to the SA/S X.16.6.1.

Description	Mod. width	Order details		Price	Weight	Pack
		Type code	Order code	1 piece	1 piece	unit
				€	kg	pc.
	4	SE/S 3.16.1	2CDG110136R0011		0.3	1



EM/S 3.16.1

Energy Module, 3-fold, 16/20 AX, MDRC

Measures energy consumption and various electrical parameters in the terminal current. Active power, Current, Voltage and Frequency can be monitored via threshold values and peak loads can be limited through a simple load control. The measured values are provided via ABB i-bus® KNX.

Description	Mod. width	Order details		Price	Weight	Pack
		Type code	Order code	1 piece	1 piece	unit
				€	kg	pc.
	4	EM/S 3.16.1	2CDG110148R0011		0.2	1



ZS/S 1.1

Meter Interface Module, MDRC

It records consumption and measured values of the electrical energy consumption meters. Using an infra-red interface, the ABB energy meter types of the A- and B-series are incorporated. The information and data which is read can be used, for example, for cost centre accounting, energy optimisation, monitoring of installations and visualisation.

The following values are available (depending on the meter type):

Meter reading

Active energy Tariff 1-4, total
Reactive energy Tariff 1-4, total

Power values

Active power L1, L2, L3, total
Reactive power L1, L2, L3, total
Apparent power L1, L2, L3, total
Phase angle power L1, L2, L3, total
Power factor L1, L2, L3, total

Instrument values

Voltages L1-N, L2-N, L3-N,
 L1-L2, L2-L3, L1-L3

Currents L1, L2, L3, N
Phase angle voltage L1, L2, L3, total
Phase angle current L1, L2, L3, total
Quadrant L1, L2, L3, total
Mains frequency

Other

Transformer ratio Read CT and VT
Power failures Send and delete
Tariffs Read and changeover
Status information Send and read
Communication
monitoring
Intermediate meter Read and reset

Description	Mod. width	Order details		Price	Weight	Pack
		Type code	Order code	1 piece	1 piece	unit
				€	kg	pc.
	2	ZS/S 1.1	2CDG110083R0011		0.13	1

Energy Management

ABB EQmatic

With the new ABB EQmatic series, ABB offers a solution for storing, displaying and analyzing the consumption data of electricity, gas, water and heat meters. Thus, energy flows and costs in the building can be monitored and made transparent.

User interface offers helpful features

The commissioning, evaluation and analysis of the data are carried out via the web-based graphical user interface. For a detailed monitoring the devices offer several analysis functions such as historical data analysis, benchmark functions, cost analysis, instantaneous values etc.

Increased Energy efficiency

This serves to increase energy efficiency and as a basis for further operational optimizations, based on the energy management standard ISO 50001.

High flexibility

Various export functions such as scheduled reports via FTP or E-Mail are available for further data processing.

The data sharing options via Modbus TCP and API allow the integration into supervisory systems.

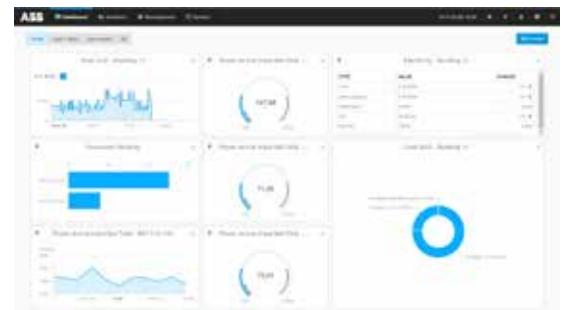

Intuitive web-based user-interface to access meters easily. It can be flexibly configured to meet specific demands. For a quick overview, metering data and analytic charts can be individually configured and arranged here.



ABB i-bus® KNX

Energy Management



QA/S 1.16.1

Energy Analyzer, KNX, 16 Devices, MDRC

Compact and web-based stand-alone device for energy management applications. For monitoring, logging, displaying and analyzing consumption data of up to 16 electricity, gas, water or heat meters via KNX TP. In addition measured values such as temperature, humidity, etc. can be processed and displayed. The alarm function allows early warning (e.g. via E-mail) if any value exceeds defined limits. The user interface provides graphical analysis functions, e.g. dashboard, historical data, instantaneous values, benchmark functions, cost allocation according to consumer groups and more. In order to increase energy efficiency, defined loads can be selectively switched off with the load control function if they exceed a configurable load limit. For further processing data can be exported cyclically (e.g. every month) via E-mail or upload to FTP server. Several data sharing options (e.g. Modbus TCP, Rest API) allow the communication with other systems.

Description	Mod. width	Order details		Price	Weight	Pack
		Type code	Order code	1 piece	1 piece	unit
	4	QA/S 1.16.1	2CDG110224R0011		0.19 kg	1 pc.

ABB i-bus® KNX

Energy Management



QA/S 3.16.1

Energy Analyzer, M-Bus, MDRC*

Compact and web-based stand-alone devices for energy management applications. For monitoring, logging, displaying and analyzing consumption data of up to 16 or 64 electricity, gas, water or heat meters via M-Bus. Automatic detection for ABB EQ meters (A/B-Series). Access to the device via web browser. The user interface provides graphical analysis functions, e.g. dashboard, historical data, instantaneous values, benchmark functions, cost allocation according to consumer groups and more. For further processing data can be exported cyclically (e.g. every month) via E-mail or upload to FTP server. Several data sharing options (e.g. Modbus TCP, Rest API) allow the communication with other systems.

* Pure M-Bus Master, no data routing from M-Bus to KNX

Description	Mod. width	Order details		Price	Weight	Pack
		Type code	Order code	1 piece	1 piece	unit
				€	kg	pc.
M-bus, 16 Devices	4	QA/S 3.16.1	2CDG110226R0011		0.15	1
M-bus, 64 Devices	4	QA/S 3.64.1	2CDG110227R0011		0.15	1



QA/S 3.64.1

Energy Analyzer, Modbus, MDRC*

Compact and web-based stand-alone devices for energy management applications. For monitoring, logging, displaying and analyzing consumption data of up to 16 or 64 electricity, gas, water or heat meters via Modbus RTU. Automatic detection for ABB EQ meters (A/B-Series). Access to the device via web browser. The user interface provides graphical analysis functions, e.g. dashboard, historical data, instantaneous values, benchmark functions, cost allocation according to consumer groups and more. For further processing data can be exported cyclically (e.g. every month) via E-mail or upload to FTP server. Several data sharing options (e.g. Modbus TCP, Rest API) allow the communication with other systems.

* Pure Modbus RTU Master, no data routing from Modbus RTU to KNX

Description	Mod. width	Order details		Price	Weight	Pack
		Type code	Order code	1 piece	1 piece	unit
				€	kg	pc.
Modbus RTU, 16 Devices	4	QA/S 4.16.1	2CDG110228R0011		0.15	1
Modbus RTU, 64 Devices	4	QA/S 4.64.1	2CDG110229R0011		0.15	1



QA/S 4.16.1



QA/S 4.64.1

ABB i-bus® KNX

Safety and Monitoring



SMB/S 1.1

Fault Monitoring Unit, MDRC

It is used to detect and manage up to 100 fault messages which are processed within the unit and can be forwarded to a display unit. Furthermore, an optical and an acoustic collective status signal is provided. Messages can be acknowledged and data losses can be reported. The devices support message formats to DIN 19 235: messages with continuous lighting, new value messages with simple flashing light, initial value messages with simple acknowledgement, motor messages. Current values can be centrally scanned.

Description	Mod. width	Order details		Price	Weight	Pack
		Type code	Order code	1 piece	1 piece	unit
				€	kg	pc.
	2	SMB/S 1.1	GHQ6310085R0111		0.12	1



EUB/S 1.1

EIB Monitoring Unit, MDRC

Monitors up to 100 bus devices in KNX systems, which can be divided into 5 groups. The devices are monitored to ensure their presence and minimum functionality (send and receive). Monitoring can be undertaken based on the physical address or the group address. A total of four different monitoring modes are available. No additional power supply required, the device is powered from KNX bus.

Description	Mod. width	Order details		Price	Weight	Pack
		Type code	Order code	1 piece	1 piece	unit
				€	kg	pc.
	2	EUB/S 1.1	2CDG110066R0011		0.12	1



BDB/S 1.1

Data Logging Unit, MDRC

It detects local operation cycles and operating hours to plan the maintenance or durability evaluation of the devices. For each of the 35 channels to be monitored, limit values can be set and a message sent if this limit is exceeded. The logging of operating hours can be predetermined for the total or remaining time. These values can be modified via communication objects. No additional power supply required, the device is powered from KNX bus.

Description	Mod. width	Order details		Price	Weight	Pack
		Type code	Order code	1 piece	1 piece	unit
				€	kg	pc.
	2	BDB/S 1.1	2CDG110067R0011		0.12	1

ABB i-bus® KNX

Security – Alarm System KNX



The compact solution for security applications – the Security Terminals
 The Security Terminal provides a compact security solution for KNX applications for detection and signalling of intrusion, personal attack and technical hazards. They are used as the interface between the security technology sensors and KNX.

Depending on the configuration, the devices feature 2, 4 or 8 inputs – so-called detector circuits or zones. They are used for monitoring connected passive detectors (e.g. magnetic contacts, glass break sensors, etc.) to the ABB i-bus® KNX as well as for connection of floating contacts in applications with enhanced security requirements.

Through the connection of security technology and KNX, the detectors employed can, in addition to the security functions, also be used for heating control (e.g. window contact signal for control of the heating valve) or lighting control (e.g. central switch off of the lighting when the alarm logic is set).

The Security Terminals can be used as autonomous systems with the integrated alarm logic, in conjunction with the Security Module SCM/S or with an Intrusion Alarm Panel GM/A 8.1 or L240.

The application program offers several functions for security applications, such as

- Direct and delayed setting
- Internal setting with occupancy and external setting when absent
- Setting of the connected detector types
- Reset input and setting input
- Detector monitoring
- Zones (detector circuits) can be switched off
- Different types of alarms
- Setting for freely programmable relay outputs, e.g. for direct control of signalling devices.



ABB i-bus® KNX

Security – Alarm System KNX

	Standard Security				Professional Security
	MT/U 2.12.2	MT/S 4.12.2M	MT/S 8.12.2M	SCM/S 1.1	GM/A 8.1
General					
Supply voltage	KNX	KNX	KNX	KNX	100 – 230 V AC
Auxiliary power supply	12 V DC	12 V DC	12 V DC	–	–
Type of installation	FM	DIN-Rail	DIN-Rail	DIN-Rail	SM
Module width (18 mm)	–	4	4	2	–
Inputs (extendable via bus)	2	4	8	0 (64)	8 (344)
Outputs	2 x Relais	3 x Relais	3 x Relais	1 x Relais	4 x Relais 4 x Signaling devices
Functions					
Connection of conventional security sensors/devices	■	■	■	–	■
Connection of 4-wired security bus sensors/devices	–	–	–	–	■
Event log	–	–	–	■ (250)	■ (10,000)
Remote alarming	Optional via KNX	Optional via KNX	Optional via KNX	Optional via KNX	Integrated E-Mail Voice messages
Back-up power supply					
Optional via NTU/S 12.2000.1 and SU/S 30.640.2	■	■	■	–	–
Optional via SU/S 30.640.2	–	–	–	■	–
Integrated back-up power	–	–	–	–	■
Certifications					
VdS	–	–	–	–	Class C
EN 50 131/IEC 62 642	–	–	–	–	Grade 3
Commissioning and diagnostic functions					
Commissioning and diagnostic via webserver	–	–	–	–	■

■ = Function is supported

– = Function is not supported

ABB i-bus® KNX

Security – Alarm System KNX



SCM/S 1.1

Security Module, MDRC

The module provides the necessary logic functions to link the various KNX devices (e.g. zone terminals) to a security system. Up to 64 different zones can be evaluated via communication objects. Arming, operation and display are also implemented using communication objects. The device has a freely programmable relay output for connection of a signal encoder. An uninterruptible KNX power supply with battery back-up is recommended for security function buffering on mains failure.

Description	Mod. width	Order details		Price	Weight	Pack unit
		Type code	Order code	1 piece	1 piece	
				€	kg	pc.
	2	SCM/S 1.1	2CDG110024R0011		0.13	1



MT/S 8.12.2M

Security Terminal

They are used as the interface between the security technology sensors and the KNX. The device features inputs, so-called zones. They are used for monitoring connected passive detectors, e.g. magnetic contacts and/or glass break sensors on the ABB i-bus® KNX and/or for connection of floating contacts in applications with enhanced security requirements. The device can be used as a system with autonomous alarm logic or in combination with the Security Module SCM/S or an Intrusion Alarm Panel. The device requires an external 12 V DC SELV auxiliary power supply, (e.g. NTU/S 12.2000.1).

Description	Mod. width	Order details		Price	Weight	Pack unit
		Type code	Order code	1 piece	1 piece	
				€	kg	pc.
4-fold, MDRC	4	MT/S 4.12.2M	2CDG110109R0011		0.19	1
8-fold, MDRC	4	MT/S 8.12.2M	2CDG110110R0011		0.19	1
2-fold, FM	–	MT/U 2.12.2	2CDG110111R0011		0.08	1

ABB i-bus® KNX

Security – Alarm System GMA

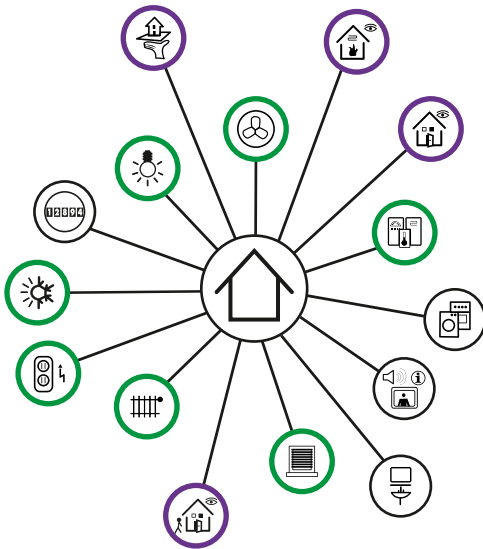

Professional alarm system for KNX experts

With the KNX Security Panel GM/A 8.1 ABB presents the first security system that is compatible with both, the international KNX standard (14543-3-x ISO / IEC) and the international standard for alarm systems (ISO / IEC 62642). Therefore the KNX Security Panel GM/A 8.1 is ready for a worldwide usage and expands business opportunities of nearly 40,000 KNX partners in 124 countries. The system is the perfect solution for projects ranging from simple to high security requirements.

ABB i-bus® KNX

Security – Alarm System GMA

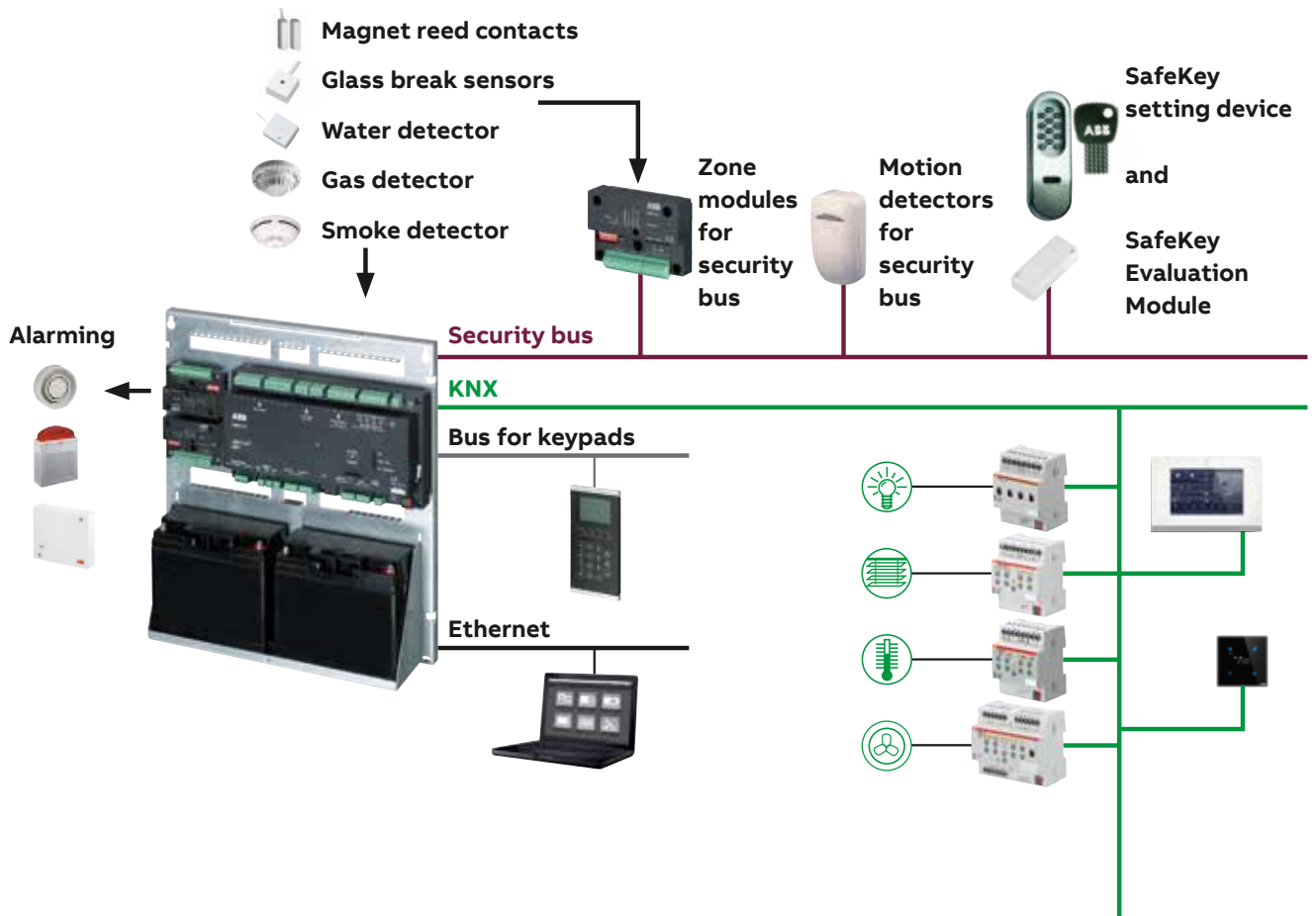

A complete product product portfolio: One system – all interfaces

To fulfill the project requirements ABB provides the user besides the panel and keypad a complete product portfolio for professional alarm technology as well as known solutions for all trades of KNX building automation.







The KNX Security Panel is for universal usage for all kinds of hazardous situations in buildings like intrusion, personal attack, smoke, gas- and water leakage.

ABB i-bus® KNX

Security – Alarm System GMA



KNX Security Panel without cover, integrated zone modules and batteries

-  Ethernet connection for programming, diagnostics and operation via a standard webbrowser
-  Direct inputs for security sensors
-  Keypads
-  Internal, external or remote alarming
-  Security bus for security sensors, zone modules and setting devices
-  KNX interface to display alarm states via displays of building automation and to control automatic building functions with support of security sensors.

The KNX Security Panel provides all needed system interfaces: An ethernet connection is used for programming, diagnostics and operation via a standard webbrowser as well as integration into the building network. The security sensors will be connected directly to the panel inputs or via the security bus, where the setting device for the system is also connected. Furthermore the panel provides interfaces for the also newly developed keypads and for internal, external or remote alarming. Finally the integrated KNX interface allows on the one hand to display alarm states via displays of building automation and on the other to control automatic building functions with support of security sensors.

ABB i-bus® KNX

Security – Alarm System GMA



GM/A 8.1

KNX Security Panel, SM

to be discontinued

For the protection of small to medium residential or commercial properties against intrusion and technical faults. The Security Panel is suitable for up to five logical areas. It has 8 integrated zones for detectors, a Security Bus for Bus-detectors, Bus-Zone Modules and Setting devices, Ethernet connection (RJ45) for programming, operating and displaying system status via Web-Browser and an integrated KNX interface. The Security Panel GM/A 8.1 complies with the requirements to VdS classes A, B and C, to the European Standard EN 50131, Grade 1 to 3 and to ISO/IEC 62642 Grade 1 to 3 as one-area system.

Description	Mod. width	Order details		Price	Weight	Pack
		Type code	Order code	1 piece	1 piece	unit
				€	kg	pc.
	–	GM/A 8.1	2CDG110150R0011		10.5	1
Off the wall tamper contact	–	WA/Z 1.1	2CDG110174R0011		0.2	1



SAK17

Sealed Lead Acid Battery, 12 V DC, 18 Ah

Sealed lead acid battery for power backup in connection with a uninterruptible power supply or security system.

Description	Mod. width	Order details		Price	Weight	Pack
		Type code	Order code	1 piece	1 piece	unit
				€	kg	pc.
	–	SAK17	GHV9240001V0013		6.487	1



BT/A 1.1



BT/A 2.1

Keypad for GM/A 8.1

to be discontinued

Used to operate and display the information of the system states of the GM/A 8.1 KNX Security Panel. System messages are displayed on a four-line LCD display. The multifunction and special keys mean that all the system functions can be operated easily. Safety-relevant functions are protected by a user PIN. Five Keypads can be connected to each Security Panel. There is no need for an external voltage supply, the keypads are supplied via the Keypad-Bus. The device can be used in systems with increased system requirements according to VdS Class A, B and C, DIN VDE 0833 Level 1, 2 and 3 and EN 50131/IEC 62642 Level 1, 2 and 3.

Description	Mod. width	Order details		Price	Weight	Pack
		Type code	Order code	1 piece	1 piece	unit
				€	kg	pc.
black	–	BT/A 1.1	2CDG280001R0011		0.5	1
white	–	BT/A 2.1	2CDG280002R0011		0.5	1

ABB i-bus® KNX

Security – Components



MG/A 4.4.1

Zone Module, 4-fold

to be discontinued

To connect to Security Panel GM/A 8.1 via the Security-Bus. For expansion of the Security-Panel by 4 detector zones. Used for connection to the exterior perimeter detectors such as magnetic reed contacts and passive glass break sensors. The module has 4 zones to which several detectors can be connected. The status of each zone is displayed with a status LED. The Zone Module delivers the control signals and the supply voltage for the external detectors. There is no need for an external voltage supply, the Zone Modules are supplied via the Security-Bus.

Description	Mod. width	Order details		Price	Weight	Pack
		Type code	Order code	1 piece	1 piece	unit
				€	kg	pc.
to mount in the Security Panel housing	–	MG/E 4.4.1	2CDG110178R0011		0.1	1
in a surface mounting housing for installation in the building	–	MG/A 4.4.1	2CDG110186R0011		0.1	1



IR/XB

Passive IR Bus Motion Detector, 15m, VdS B

to be discontinued

For direct connection to the security-bus of the Intrusion Alarm Panel GM/A 8.1. The motion detector with passive infrared technology is VdS class B / EN Grade 2 certified. It facilitates monitoring of an area with an infrared range of up to 15 m.

Description	Mod. width	Order details		Price	Weight	Pack
		Type code	Order code	1 piece	1 piece	unit
				€	kg	pc.
VdS B/EN Grade 2	–	IR/XB	2CDG230023R0011		0.15	1



EIM/XB

Dualtech Bus Motion Detector, 15m, VdS B

to be discontinued

For direct connection to the security-bus of the Intrusion Alarm Panel GM/A 8.1. The Dual-Motion Detector combines proven passive infra-red technology with temperature-independent microwave technology. The combination of both functional principles results in a detector featuring high immunity to false alarms, even with unfavourable ambient conditions, and which still has high detection security. The detector is VdS class B / EN Grade 2 certified. It facilitates monitoring of an area with an infrared range of up to 15 m. For use in EU countries only.

Description	Mod. width	Order details		Price	Weight	Pack
		Type code	Order code	1 piece	1 piece	unit
				€	kg	pc.
VdS B/EN Grade 2	–	EIM/XB	2CDG230025R0011		0.15	1

ABB i-bus® KNX

Security – Components



L240/BS

SafeKey Evaluation Module

to be discontinued

For connection of the SafeKey components as well as all components required for a setting door (magnetic contacts, lock bolt switching contact, bolt lock, internal siren). For direct connection to the security-bus of the Intrusion Alarm Panel GM/A 8.1. The management of the electronic keys from the SafeKey range is undertaken completely via the WebUI of the Security Panel GM/A 8.1.

Description	Mod. width	Order details		Price	Weight	Pack
		Type code	Order code	1 piece	1 piece	unit
				€	kg	pc.
	–	L240/BS	GHQ3050031R0001		0.13	1



SAD/GAP

Distribution Box, SM

to be discontinued

For installation of the Bus Module L240/BS.

Description	Mod. width	Order details		Price	Weight	Pack
		Type code	Order code	1 piece	1 piece	unit
				€	kg	pc.
	–	SAD/GAP	2CDG220021R0011		0.131	1



SCS

SafeKey Chipkey

to be discontinued

It is an electronic carrier medium for setting / unsetting via a SafeKey Wall Reader. A SafeKey Chipkey can be authorized for any number of different SafeKey systems with different levels of authorization.

Description	Mod. width	Order details		Price	Weight	Pack
		Type code	Order code	1 piece	1 piece	unit
				€	kg	pc.
	–	SCS	GHQ3050027R0001		0.02	1



WEL/A, ES

SafeKey Chipreader, SM**to be discontinued**

For setting/unsetting with the Evaluation Module L240/BS. The unit is actuated by inserting the electronic SafeKey chipkey. The SafeKey Wall Reader WEL is equipped with the key reader and an acknowledgement buzzer. VdS class C.

Description	Mod. width	Order details		Price	Weight	Pack
		Type code	Order code	1 piece	1 piece	unit
				€	kg	pc.
	-	WEL/A, ES	GHQ3050023R0001		0.38	1



WELT/A, ES

SafeKey Chipreader with Keypad, SM**to be discontinued**

For setting/unsetting with the Evaluation Module L240/BS. The unit is actuated by inserting the electronic SafeKey chipkey. The SafeKey Wall Reader WELT is equipped with the key reader, a keypad and an acknowledgement buzzer.

Description	Mod. width	Order details		Price	Weight	Pack
		Type code	Order code	1 piece	1 piece	unit
				€	kg	pc.
	-	WELT/A, ES	GHQ3050024R0001		0.45	1



ESPE/M

Electrical Mini Bolt Lock**to be discontinued**

The ESPE/M Mini Bolt Lock is used together with an intrusion alarm system to implement the inevitability condition. The motorized bolt lock additionally locks the door to the set area, preventing unintentional opening of the door when the intrusion alarm system is set. The ESPE/M Mini Bolt Lock is connected to the L240/BS Evaluation module for GM/A 8.1 KNX Security Panel.

Description	Mod. width	Order details		Price	Weight	Pack
		Type code	Order code	1 piece	1 piece	unit
				€	kg	pc.
	-	ESPE/M	2CDG270010R0011		0.13	1

ABB i-bus® KNX

Security – Components



EIM/D

Dualtech Ceiling Detector, EN Grade 2, 10 m

to be discontinued

Operates according to the proven detection principle of the EIM detector (infra-red technology and electromagnetic field) over 360°. The range of the infrared component can be adapted via the mounting height while the range of the electromagnetic field can be adjusted separately using a jumper. The detector is fitted with a walk test LED. Colour: RAL 9010 pure white. For use in EU countries only.

Description	Mod. width	Order details		Price	Weight	Pack unit
		Type code	Order code	1 piece	1 piece	
				€	kg	pc.
	–	EIM/D	2CDG230039R0011		0.14	1



MRS/W

Magnet Reed Contact Set

For opening surveillance of windows and doors, complete for bolting or drilling. Contents: 1 magnet, 1 reed contact with 4.0 m connection cable LIYY 4 x 0.14 mm², 2 housings, 2 spacer plates, 2 flanges and 4 anti-magnetic fixing screws. VdS class B.

Description	Mod. width	Order details		Price	Weight	Pack unit
		Type code	Order code	1 piece	1 piece	
				€	kg	pc.
white	–	MRS/W ¹⁾	GHQ3201972R0001		0.1	1
brown	–	MRS/B	GHQ3201972R0002		0.1	1
Saver Set (20 pcs.), white	–	VMRS/W ¹⁾	GHQ3201972R0011		1.99	1
Saver Set (20 pcs.), brown	–	VMRS/B	GHQ3201972R0012		1.99	1

¹⁾ to be discontinued



MC-C 1.1

Rolling Door Reed Contact

The Rolling Door Reed Contact Set is mounted mainly on rolling, sliding, and tilting doors. The contact housing is mounted on the ground (a flat support surface is required).

Only screws made of anti-magnetic material may be used for mounting.

Due to the weatherproof and mechanically stable design of the contact housing, the circuit is mostly protected against damage when rubber-tired vehicles drive over it.

The 4-wire cable is protected by a plastic-coated metal hose.

Description	Mod. width	Order details		Price	Weight	Pack unit
		Type code	Order code	1 piece	1 piece	
				€	kg	pc.
VdS Class B, EN Grade 2	–	MC-C1.1	2CDG250006R0011		0.3	1



SPGS/W

Passive Glass Break Sensor

For opening surveillance of windows and doors, complete for bolting or drilling. VdS class B.

Description	Mod. width	Order details		Price	Weight	Pack unit
		Type code	Order code	1 piece	1 piece	
				€	kg	pc.
white	–	SPGS/W	GHV9220004V0009		0.11	1
Loctite Adhesive for Glass Breaking Detectors	–	LKS ¹⁾	GHQ4001906R0001		0.06	1
Electrical Tester for SPGS	–	GP2 ¹⁾	GHV9220004V0004		0.1	1

¹⁾ to be discontinued



WRK/W

Lock Bolt Switching Contact with Connection Cable

For installation in the strike plate, for lock monitoring on doors. Water-tight IP 67, with 2.5 m connection cable LIYY 3 x 0.14 mm². VdS class C.

Description	Mod. width	Order details		Price	Weight	Pack
		Type code	Order code	1 piece	1 piece	unit
				€	kg	pc.
	-	WRK/W	2CDG250003R0011		0.03	1



VSUE

Window Lock Monitoring Contact

to be discontinued

Lock monitoring is carried out with a special magnet and a reed contact. The magnet is mounted on the push rod of the window sash while the reed contact is mounted on the frame. The connection cable LIYY 4 x 0.14 mm² is 4 m in length. VdS No. G 190074. VdS class C.

Description	Mod. width	Order details		Price	Weight	Pack
		Type code	Order code	1 piece	1 piece	unit
				€	kg	pc.
	-	VSUE	GHV9210018V0022		0.09	1



ND/W

Emergency Call Button, white

to be discontinued

For manual alarm tripping. Complies with the police regulations since it features permanent trip recognition, momentary-contact function, with cover contact. Surface mount version. Colour: white. VdS class C.

Description	Mod. width	Order details		Price	Weight	Pack
		Type code	Order code	1 piece	1 piece	unit
				€	kg	pc.
Surface mounting	-	ND/W	GHQ7132443R0011		0.15	1
Flush mounting	-	NDU/W	GHQ7132443R0021		0.15	1



NDA/W

Cover Plate for Emergency Call Button, white

to be discontinued

Used primarily in the banking sector or other institutions, where unintentional alarm triggering is possible due to public access.

Description	Mod. width	Order details		Price	Weight	Pack
		Type code	Order code	1 piece	1 piece	unit
				€	kg	pc.
	-	NDA/W	GHQ7132443R0004		0.03	1

ABB i-bus® KNX

Security – Components



TD-C 1.1

Gas Detector with Relay Contact

The Gas Detector is used for monitoring gas leakage of domestic and commercial rooms. It detects gases like propane, methane and butane as well als acetylene, city gas and natural gas. The detector can be connected to ABB intrusion and fire alarm control panels, as well as ABB i-bus® binary inputs via a potential-free relay contact. Suitable as a stand-alone device. An external power supply with 12-24 V DC is required.

Description	Mod. width	Order details		Price	Weight	Pack
		Type code	Order code	1 piece	1 piece	unit
				€	kg	pc.
	-	TD-C 1.1	2CDG220023R0011		0.167	1



SWM 4

Water Detector for Detector Groups

A resin-encapsulated water detector with gold-plated Termipoint pins, detects water ingress, e.g., pipe fractures, ingress of groundwater and sewage, water damage caused by washing machines and dishwashers etc. before the damage becomes too expensive. For operation directly on detector circuits of intrusion alarm panels or security terminals.

Description	Mod. width	Order details		Price	Weight	Pack
		Type code	Order code	1 piece	1 piece	unit
				€	kg	pc.
	-	SWM 4	GHQ4030001R0004		0.16	1



SWM 4/RN

Water Detector with Relay, 12 V

Features a potential free changeover contact output, an LED parallel output and a LED display. The detector resets itself automatically when the affected area dries out. The device draws its power from an external 10 ... 23 V DC voltage source.

Description	Mod. width	Order details		Price	Weight	Pack
		Type code	Order code	1 piece	1 piece	unit
				€	kg	pc.
	-	SWM4/RN	GHQ4030001R0012		0.23	1



FC650/O

Optical Smoke Detector

Optical smoke detector in threshold alarm technology that detects smoke according to the scattered-light principle. The detectors feature an alarm indicator on the detector head that is visible from all angles, and which can be triggered with a permanent magnet for test purposes. A detector base is provided for mounting and cable connection purposes into which the detector is simply screwed in via the bayonet connection. Each detector is equipped with an alarm LED, which displays the stored alarm in the event of an alarm. Detector/base diameter: 110 mm. VdS approved.

Description	Mod. width	Order details		Price	Weight	Pack unit
		Type code	Order code	1 piece	1 piece	
				€	kg	pc.
	-	FC650/O	2CDG430079R0011		0.09	1



FC650/TMAX

Thermal Maximum Detector

Static Heat Detector in threshold alarm technology, – trigger temperature 78 °C. The detectors feature an alarm indicator on the detector head that is visible from all angles, and which can be triggered with a permanent magnet for test purposes. A detector base is provided for mounting and cable connection purposes into which the detector is simply screwed-in via the bayonet connection. Each detector is equipped with an alarm LED, which displays the stored alarm in the event of an alarm. Detector/base diameter: 110 mm. VdS approved.

Description	Mod. width	Order details		Price	Weight	Pack unit
		Type code	Order code	1 piece	1 piece	
				€	kg	pc.
	-	FC650/TMAX	2CDG430081R0011		0.09	1



FC600/BREL

Relay Base, 12/24 V

Enables system-independent connection of the FC650 series fire detector to systems or devices that are not specifically designed for this detector technology. Examples include Intrusion Alarm Panels, KNX Security Terminals, elevator controls or other signal processing equipment. The detector base must be supplied by either a 12 V or a 24 V DC voltage supply. A floating 30 V DC/1 A changeover contacting is provided for transferring an alarm.

Description	Mod. width	Order details		Price	Weight	Pack unit
		Type code	Order code	1 piece	1 piece	
				€	kg	pc.
	-	FC600/BREL	2CDG430051R0011		0.08	1

ABB i-bus® KNX

Security – Components



6833/01-84-500

Busch-Smoke Alarm® ProfessionalLine

For early detection of smouldering fires and open fires with smoke development indoors according to the photooptical measurement principle (Tyndall). With installed Lithium battery. Battery life min. 10 years. With test button and muting. Can be networked with up to 12 detectors using the radio module. Can be networked via 2-wire twisted pair cable with up to 12 detectors. Acoustic alarm: installed horn (85 dBA). Cyclic functional test. Including attachment material – VdS certified. Conform to EN 14604 studio white.

Description	Mod. width	Order details		Price	Weight	Pack unit
		Type code	Order code	1 piece	1 piece	
				€	kg	pc.
not networkable	–	6833-84-500	2CKA006800A2720		0.154	1
networkable	–	6833/01-84-500	2CKA006800A2721		0.268	1



6835/01-84-500

Busch-Heat Alarm ProfessionalLine

Signal triggered at over 57 °C. With installed Lithium battery. Battery life min. 10 years. With test button and muting. Can be networked via 2-wire twisted pair cable with up to 12 detectors. Can be networked with up to 12 detectors using the radio module. Acoustic alarm: installed horn (85 dBA). Cyclic functional test. Including attachment material – VdS certified. Conform to EN 14604.

Description	Mod. width	Order details		Price	Weight	Pack unit
		Type code	Order code	1 piece	1 piece	
				€	kg	pc.
studio white	–	6835/01-84-500	2CKA006800A2723		0.268	1



6827-84

Busch-Smoke Alarm® Radio Module

For wireless networking of multiple Busch smoke alarms® / heat alarms. With installed Lithium battery. Battery life min. 10 years. Radio frequency: 868 MHz. Range: max. 100 m outdoors, max. 30 m indoors.

Description	Mod. width	Order details		Price	Weight	Pack unit
		Type code	Order code	1 piece	1 piece	
				€	kg	pc.
	–	6828	2CKA006800A2514		0.268	1



6829-84

Busch-Smoke Alarm® Relay

For connecting external systems, e.g. KNX. Relay contact, floating changeover contact 230 V~ max. 5 A. Cable connection: up to 2 x 2 x 1.5 mm². With installed radio module. Rated voltage: 230 V~.

Description	Mod. width	Order details		Price	Weight	Pack unit
		Type code	Order code	1 piece	1 piece	
				€	kg	pc.
studio white	-	6829-84	2CKA006800A2515		0.268	1



6824-84

Busch-Smoke Alarm® Remote Control

For service purposes. With muting, test and search function.

Description	Mod. width	Order details		Price	Weight	Pack unit
		Type code	Order code	1 piece	1 piece	
				€	kg	pc.
studio white	-	6824-84	2CKA006800A2516		0.268	1



SSS

Indoor Siren, 12 V DC

Electronic solid-state siren with intermittent tone for alarm purposes in indoor installations. External dimensions: \varnothing x H = 90 x 37 mm.

Description	Mod. width	Order details		Price	Weight	Pack unit
		Type code	Order code	1 piece	1 piece	
				€	kg	pc.
	-	SSS	GHV9270001V0001		0.17	1



SSF/G

Siren in Enclosure

to be discontinued

An aluminium protective housing with additional protective enamel coating. Protected against sabotage by a case tamper contact. The alarm inputs are wired onto a terminal strip. With fixing screw (M4) for potential equalization on the base.

Dimensions: H x W x D = 200 x 205 x 88 mm; Color: RAL 9002 Environmental class III to VdS.

Description	Mod. width	Order details		Price	Weight	Pack unit
		Type code	Order code	1 piece	1 piece	
				€	kg	pc.
	-	SSF/G	GHQ3050017R0001		1.64	1



SSF/GB

Siren with Strobe

An aluminium protective housing with additional protective enamel coating. Protected against sabotage by a case tamper contact. The alarm inputs are wired onto a terminal strip. With fixing screw (M4) for potential equalization on the base.

Dimensions: H x W x D = 258 x 205 x 88 mm; Color: RAL 9002 Environmental class III to VdS.

Description	Mod. width	Order details		Price	Weight	Pack unit
		Type code	Order code	1 piece	1 piece	
				€	kg	pc.
	-	SSF/GB	GHQ3050018R0001		1.81	1

Bright prospects for all

We bring energy to buildings and the people within them – whether these are modern single residential units, all kinds of hotels or ground-breaking industrial buildings. For us, power is more than just what comes from the wire. Why? Because it forms the basis of a comfortable life. As a result, we are constantly improving every little detail, looking for the most userfriendly solution and bringing people and technology together. That's what our large company is all about – we do everything to give you the freedom of choice.

A vision for the perfect building

What's key is the synergy created in the building as a whole. It starts with the power that's created using renewable sources of energy, which then feeds into the things that this power can do for the people within – from the infrastructure in the buildings right through to the emotional experience of the occupants, from the lowest parking level right through to the most exquisite penthouse suite. Only when everything intertwines are values created, which you can experience with all your senses.

Building automation from ABB governed by our core values

All ABB solutions are checked against the six core values and constantly improved until they meet the very highest requirements in terms of technology, management and the guests.





Economic efficiency

A hotel building is for the people within. This is the only way to measure the value of what's inside. Every day, development gives rise to performance.

Safety

The building automation technology can't take a break. With a complete system, the management can count on it as a whole – and on the fact that everything is functioning safely.

Energy efficiency

You need energy for absolutely anything you wish to accomplish. That's why, for ABB, it is crucial to never waste energy and to make the most of it at the same time.

Durability

The future always comes quicker than you think. It must be easy to upgrade the technology. The new fits perfectly with what is already there.

Design

Hotels are more than just buildings. They shape the city and are sometimes a key part of the skyline. The aesthetics count – from the largest detail right down to the smallest.

Sustainability

A safe future starts today with technologies which combine all energy-saving capabilities with quality of life.

ABB i-bus® KNX

Guest Room Management

Room Outdoor Sensor with Bus Coupler, FM

Ordering possible only in connection with the design ID. The icons and/or texts are configured by means of a web configuration tool. Freely programmable function "Do not disturb", "Bell" and "Make up room". Push switch function: switching / dimming / blind / sending values / scenes etc. Support of KNX functions through innovative colour concept (yellow=lighting, blue=blind, orange=RTC, magenta=scene and white=neutral/no function assigned) or standard illumination red/green. With integrated KNX bus coupler. With integrated temperature sensor and proximity function. The bus connection is provided via the enclosed bus terminal.



TA/U3.1.1-CG

Description	Standard Design ID	Order details		Price 1 piece	Dimensions	Pack unit
		Type code	Order code			
Standard customization ¹⁾	Go to configurator	TA/U3.1.1-CG	2CKA006300A1549	€	86x86 mm	1 pc.
Premium customization ¹⁾	Go to configurator	TA/U3-CG	2CKA006300A1646	€	86x86 mm	1 pc.



TA/U3.2.1-CG

Description	Standard Design ID	Order details		Price 1 piece	Dimensions	Pack unit
		Type code	Order code			
Standard customization ¹⁾	Go to configurator	TA/U3.2.1-CG	2CKA006300A1585	€	86x115 mm	1 pc.
Premium customization ¹⁾	Go to configurator	TA/U3-CG	2CKA006300A1646	€	86x115 mm	1 pc.



TA/U3.3.1-CG

Description	Standard Design ID	Order details		Price 1 piece	Dimensions	Pack unit
		Type code	Order code			
Standard customization ¹⁾	Go to configurator	TA/U3.3.1-CG	2CKA006300A1597	€	115x86 mm	1 pc.
Premium customization ¹⁾	Go to configurator	TA/U3-CG	2CKA006300A1646	€	115x86 mm	1 pc.

¹⁾ The individual design can be selected via the website:

URL: <https://tacteo-configurator.eu.mybuildings.abb.com/>

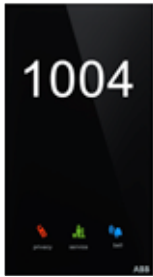

TSN/U.2.1-CG

Room Outdoor Sensor with Room Number and Bus Coupler, FM

Ordering possible only in connection with the design ID. The icons and/or texts are configured by means of a web configuration tool. Freely programmable function "Do not disturb", "Bell" and "Make up room". With backlit room number. Push switch function: switching / dimming / blind / sending values / scenes etc. Support of KNX functions through innovative colour concept (yellow=lighting, blue=blind, orange=RTC, magenta=scene and white=neutral/no function assigned) or standard illumination red/green. With integrated KNX bus coupler. The bus connection is provided via the enclosed bus terminal. The device requires a 12...24 V AC/DC external power supply to ensure its operation even with bus voltage failure.

Description	Standard Design ID	Order details		Price 1 piece	Dimensions mm	Pack unit
		Type code	Order code			
Standard customization ¹⁾	Go to configurator	TSN/U.2.1-CG	2CKA006300A1603	€	86x157	1
Premium customization ¹⁾	Go to configurator	TSN/U-CG	2CKA006300A1653	€	86x157	1



TP/T 1

USB Programmer - MIFARE

USB programmer for programming MIFARE transponder cards for tacteo access control range. The USB programmer has to be connected to the PC using the USB cable provided with the USB programmer. Cards programming has to be performed, using USB programmer, with ABB MiniMAC software (will be discontinued) or ABB RoomGuard Software.

Description	Mod. width	Order details		Price 1 piece	Weight 1 piece	Pack unit
		Type code	Order code			
	-	TP/T 1	2CSY289621R3801	€	0.08 kg	1 pc.



TZE/U.0.2.CK

Removal protection for access control devices for squared, horizontal and room number glass versions

Prevents the disassembly of ABB tacteo® card holders, card readers and external room sensors with/without card readers and room numbers.

Description	Mod. width	Order details		Price 1 piece	Weight 1 piece	Pack unit
		Type code	Order code			
	-	TZE/U.0.2.CK	2CSY245271S3601	€	kg	pc.



TZE/U.0.3.CK

Removal protection for access control devices for vertical glass versions

Prevents the dismantling of ABB tacteo® card holders, card readers and external room sensors with/without card readers and room numbers.

Description	Mod. width	Order details		Price 1 piece	Weight 1 piece	Pack unit
		Type code	Order code			
	-	TZE/U.0.3.CK	2CSY233741S3611	€	kg	pc.

¹⁾ The individual design can be selected via the website:

URL: <https://tacteo-configurator.eu.mybuildings.abb.com/>

ABB i-bus® KNX

Guest Room Management

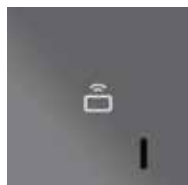

TR/U 1.1

Transponder Reader, MIFARE

The “transponder reader” is a flush-mounting device for British Standard wall boxes, designed to realize access control systems with a communication support based on KNX bus. It is equipped with one relay (4A @24 V AC/DC) and one input to be used for connecting external conventional card-holder (e.g. Millenium wiring accessories card-holder). The output can be programmed in three different ways: “Linked to access control”, receiving in this case switching commands from the device itself (according to transponder card validation); being a standard KNX Switch actuator output, able to be controlled by every KNX standard devices; “linked to card-holder”, that means that the relay is switched according to closing/opening internal input contact available on transponder reader. The bicolor (red-green) LED placed on the front of the device allow you to monitor device operation and can be also switched ON/OFF in the proper color according to KNX telegram (for example for DND/MUR purposes). The transponder reader can be configured with MiniMAC software (will be discontinued) or RoomGuard Software in order to behave as transponder programming device. The transponder reader requires a 12...24 V AC/DC external power supply to ensure its operation even with bus voltage failure.

Description	Mod. width	Order details		Price	Weight	Pack unit
		Type code	Order code	1 piece	1 piece	
				€	kg	pc.
	–	TR/U 1.1	2CSY235683R2001		0.050	1



TH/U 1.1

Transponder Holder, MIFARE

The “transponder holder” is a flush-mounting device for British Standard wall boxes, designed to realize access control systems with a communication support based on KNX bus. It is equipped with one relay (4 A @24 V AC/DC) and one binary input to be used for connecting external conventional push-button for switch, dimmer and shutter functionalities, or for example for connecting window contact or similar.

The output can be programmed as “Linked to access control”, receiving in this case switching commands from the device itself (according to card insertion/removal); or being a standard KNX Switch actuator output, able to be controlled by every KNX-standard devices. The bicolor (red-green) LED placed on the front of the device allow you to monitor device operation and can be also switched ON/OFF in the proper color according to KNX.

The transponder reader requires a 12...24 V AC/DC external power supply to ensure its operation even with bus voltage failure.

The transponder reader is available for ABB Millenium wiring accessories range.

Description	Mod. width	Order details		Price	Weight	Pack unit
		Type code	Order code	1 piece	1 piece	
				€	kg	pc.
	–	TH/U 1.1	2CSY265232R2021		0.018	1

¹⁾ The individual design can be selected via the website:

URL: <https://tacteo-configurator.eu.mybuildings.abb.com/>



TR/U 1.1.CH

Transponder Reader, Chiara 2 modules

The “transponder reader” is a flush-mounting device, designed to realize access control systems with a communication support based on KNX bus. It is equipped with one relay (4 A @24 V AC/DC) and one input to be used for connecting external conventional card-holder (e.g. Chiara wiring accessories card-holder).

The output can be programmed in three different ways: “Linked to access control”, receiving in this case switching commands from the device itself (according to transponder card validation); being a standard KNX Switch actuator output, able to be controlled by every KNX-standard devices; “linked to card-holder”, that means that the relay is switched according to closing/opening internal input contact available on transponder reader.

The bicolor (red-green) LED placed on the front of the device allow you to monitor device operation and can be also switched ON/OFF in the proper color according to KNX telegram (for example for DND/MUR purposes).

The transponder reader requires a 12...24 V AC/DC external power supply to ensure its operation even with bus voltage failure.

The transponder reader is available for ABB Chiara wiring accessories range.

Description	Mod. width	Order details		Price	Weight	Pack
		Type code	Order code	1 piece	1 piece	unit
					kg	pc.
	-	TR/U 1.1.CH	2CSK289601R1902			1



TH/U 1.1.CH

Transponder Holder, Chiara 2 modules

The “transponder holder” is a flush-mounting device for British Standard wall boxes, designed to realize access control systems with a communication support based on KNX bus. It is equipped with one relay (4 A @24 V AC/DC) and one binary input to be used for connecting external conventional push-button for switch, dimmer and shutter functionalities, or for example for connecting window contact or similar.

The output can be programmed as “Linked to access control”, receiving in this case switching commands from the device itself (according to card insertion/removal); or being a standard KNX Switch actuator output, able to be controlled by every KNX-standard devices. The bicolor (red-green) LED placed on the front of the device allow you to monitor device operation and can be also switched ON/OFF in the proper color according to KNX.

The transponder reader requires a 12...24 V AC/DC external power supply to ensure its operation even with bus voltage failure.

The transponder reader is available for ABB Chiara wiring accessories range.

Description	Mod. width	Order details		Price	Weight	Pack
		Type code	Order code	1 piece	1 piece	unit
					kg	pc.
	-	TH/U 1.1.CH	2CSK202481R1922			1

ABB i-bus® KNX

Guest Room Management



TS/T 1
TS/T 1.1

Set of Transponder Cards for Millenium, Chiara 2 modules and tacteo design programs

The transponder card uses passive transponder technology operating in radio frequency (MIFARE technology), without the need for contact between the reader and the card itself. The transponder card is read by swiping it in front of the reader at a maximum distance of 20 mm (can be reduced according to installation environment).

Description	Mod. width	Order details		Price	Weight	Pack
		Type code	Order code	1 piece	1 piece	unit
			€	kg	pc.	
10 transponder cards	–	TS/T 1	2CSY259412R2041		0.02	1
1000 transponder cards	–	TS/T 1.1	2CSY232175R2041		1	1



CH/T 2
CH/T 2.1

Set of 5 Transponder Cards for Chiara and Mylos design programs

The transponder card uses passive transponder technology operating in radio frequency, without the need for contact between the reader and the card itself. The transponder card is read by swiping it in front of the reader at a maximum distance of 20 mm.

Description	Mod. width	Order details		Price	Weight	Pack
		Type code	Order code	1 piece	1 piece	unit
			€	kg	pc.	
5 transponder cards	–	CH/T 2	2CSKK5400C		0.005	1
1000 transponder cards	–	CH/T 2.1	2CSY289611R1941		1	1



LT/U 1.1.CH

Transponder Reader, Chiara

The transponder reader is used for access control in the hotel, residential and commercial sectors (office buildings, business centers, laboratories, etc.). The device is equipped with two bistable relays (8 A, 250 V AC), one of which can be assigned to control electronic lock, and three voltage-free, non-optically insulated inputs; the 5-V DC scanning voltage is available on the COM terminal.

The transponder reader requires a 10...32 V DC/12...24 V AC external power supply to ensure its operation even with bus voltage failure.

Description	Mod. width	Order details		Price	Weight	Pack
		Type code	Order code	1 piece	1 piece	unit
			€	kg	pc.	
white	–	LT/U 1.1.CH	2CSKK5000C		0.05	1



PTI/U 1.1.CH

Transponder Holder, Chiara

The transponder holder is equipped with a slot into which the transponder card is inserted. In a hotel application, this allows occupancy recognition and notification at the supervisory level (e.g. on the front desk computer).

Moreover, room status information can be managed by using special cards (minibar status, maintenance status, usability).

The device is equipped with 2 bistable relays (8 A, 250 V AC) and 3 voltage-free, non-optically insulated inputs; the 5-V DC scanning voltage is available on the COM terminal.

The transponder pocket requires a 10...32 V DC/12...24 V AC external power supply to ensure its operation even with bus voltage failure.

Description	Mod. width	Order details		Price	Weight	Pack
		Type code	Order code	1 piece	1 piece	unit
				€	kg	pc.
white	-	PTI/U 1.1.CH	2CSKK5200C		0.05	1



PRT/U 1.1.CH

Transponder Programming Device, Chiara

The devices allows the programming of transponder cards.

The device is equipped with 2 bistable relays (8 A, 250 V AC) and 3 voltage-free non-optically insulated inputs; 5 V DC scanning voltage is available on the COM terminal.

The transponder programmer requires a 10...32 V DC/12...24 V AC external power supply to ensure its operation even with bus voltage failure.

Description	Mod. width	Order details		Price	Weight	Pack
		Type code	Order code	1 piece	1 piece	unit
				€	kg	pc.
white	-	PRT/U 1.1.CH	2CSKK5300C		0.05	1



SW MiniMAC 4.1

MiniMAC software

The management and configuration software ensures bidirectional communication with the access control system devices, allowing the system's configuration during its installation and its overall management and supervision.

Description	Mod. width	Order details		Price	Weight	Pack
		Type code	Order code	1 piece	1 piece	unit
				€	kg	pc.
	-	SW MiniMAC 4.1	2CSY258202R2051		0.005	1

ABB i-bus® KNX

Guest Room Management



RoomGuard software

RoomGuard software

NEW

RoomGuard software for configuration and supervision of ABB Access Control range; Tacteo, Millenium, Zenit, Chiara, and Mylos.

RoomGuard is a web-based scalable solution (licensing model based on number of rooms) accessible by any browser providing greater accessibility for hotel and maintenance staff. Main features and functionality include: Access control (management of keys, groups, time bands and staff cards, definition of access to common areas, and more), room state monitoring, guest check in/check out, front desk room load monitoring, management of guest and employee databases, Occupancy and access records and statistics, front desk management of room climate, and maintenance and diagnostics. RoomGuard features an intuitive and easy to use interface, with straightforward installation and configuration, seamless integration with building automation and third-party software integration.

RoomGuard software replaces MiniMAC software.

Available June 2023

Description	Mod. width	Order details		Price	Weight	Pack
		Type code	Order code	1 piece	1 piece	unit
				€	kg	pc.
RoomGuard software, 10 readers/rooms	–	RoomGuard-10	2CSY247450R0010	–	–	1
RoomGuard software, 20 readers/rooms	–	RoomGuard-20	2CSY244490R0020	–	–	1
RoomGuard software, 50 readers/rooms	–	RoomGuard-50	2CSY249580R0050	–	–	1
RoomGuard software, 100 readers/rooms	–	RoomGuard-100	2CSY242150R0100	–	–	1
RoomGuard software, 200 readers/rooms	–	RoomGuard-200	2CSY247240R0200	–	–	1
RoomGuard software, PMS interface	–	RoomGuard-PMS	2CSY244280R0999	–	–	1

ABB i-bus® KNX

User Operation – Design Ranges –
Unique diversity of the range

01

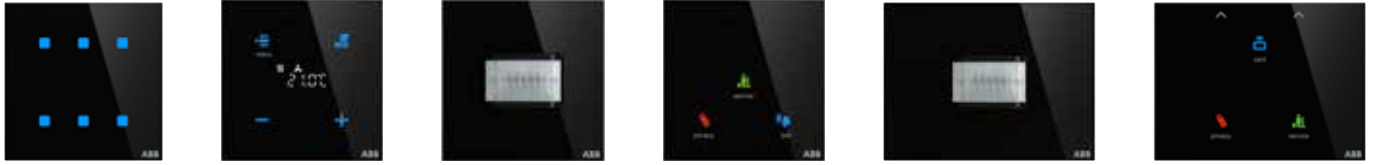

02



03

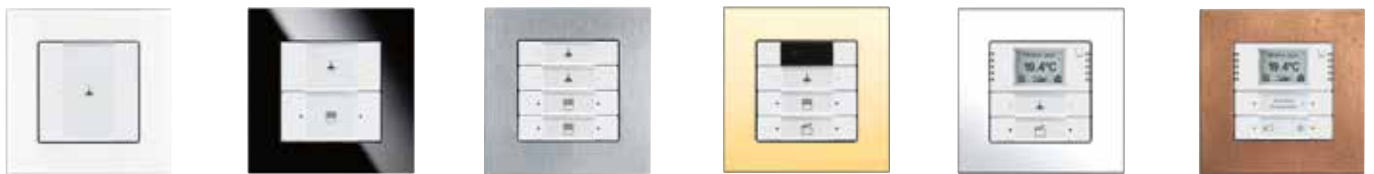

04



05



06



07

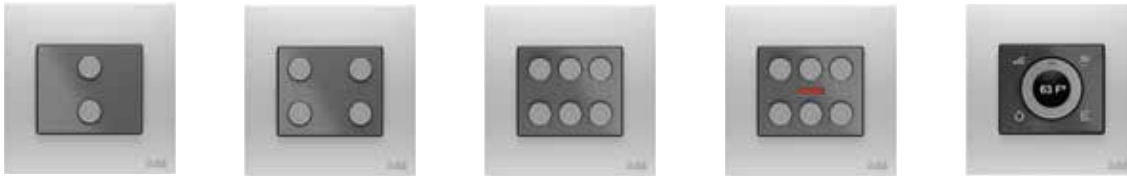

08



09



10



11

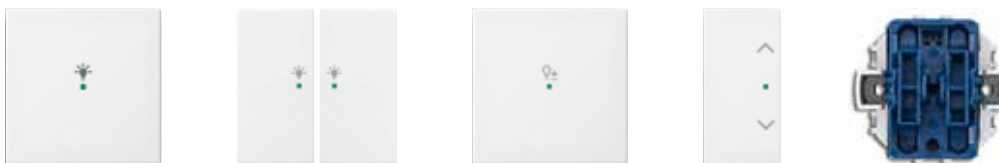

- 01 tacteo
- 02 ABB Tenton®
- 03 carat®
- 04 pure stainless steel
- 05 Busch-axcent®
- 06 future® linear
- 07 Millenium*

- 08 Zenit for VDE/NEMA markets
- 09 Busch-triton®
- 10 Busch-priOn®
- 11 Bus Coupling Unit –
for conventional Busch-Jaeger series**

Further information regarding the ABB switch ranges are available on <https://new.abb.com/low-voltage/products/residential-products/switch-ranges>





* Millenium and Zenit series are only available in selected markets.

** Busch-Jaeger switch ranges only available for selected markets. For further information please contact your local ABB office.

ABB i-bus® KNX

User Operation – Design Ranges – Functional Overview

Program	Busch-priOn® suitable for KNX bus coupler 6120/12-101 or 6120/13 (depending on the specific combination)		
			
	6340-xx-101 1/2 gang	6341-xx-101 rotary control element	6342-xx-101 3/6 gang
KNX function			
Switching, rocker switch total	■	-	■
Switching, rocker switch left/right	■	■	■
Dimming, rocker switch total	■	-	■
Dimming, rocker switch left/right	■	-	■
Blind, rocker switch total	■	-	■
Blind, rocker switch total left/right	■	■	■
Short-long operation, rocker switch left/right	■	-	■
Value sender, rocker switch total	■	-	■
Value sender, rocker switch left/right	■	-	■
Value dimming sensor, rocker switch total	■	■	■
Red/green LED status illumination (red/green/off)	-	-	-
RGB LED function illumination + status illumination	1 LED per rocker switch	1 LED per button	1 LED per rocker switch
Setting the RTC operating mode	■	-	■
Value sender, 2 objects, rocker switch left/right	■	-	■
Light scene extension unit with light scene memory function	■	-	■
Level switch, rocker switch total	■	-	■
Level switch, rocker switch total left/right	■	-	■
Multiple operation, rocker switch left/right	■	-	■
IR remote control channels (up to 13 channels)	-	-	-
Light scene unit (8 scenes for up to 8 actuators)	-	-	-
Light scene unit (10 scenes for up to 10 actuators)	-	-	-
Programmable shift key	-	-	-
Proximity function	-	-	-
Room temperature controller only			
Temperature reading	-	-	-
RTC settings	-	-	-
Illuminated display	-	-	-
Fan coil operation for heating and cooling	-	-	-
Media box/CD/DVD/radio	-	-	-
Short-time timer	-	-	-
Weekly timer	-	-	-
Alarm clock	-	-	-
Messages	-	-	-
Screen saver	-	-	-
Display text/value	-	-	-
Device lock	-	-	-
Logic function (including light scenes)	■	■	■
Busch-Watchdog 4 channels	-	-	-

■ = Function is supported

- = Function is not supported

Program



6345-xx-101



6351-825-101 end strip top with information display, room temperature controller, IR receiver and proximity sensor + 6342-xx-101 3/6 gang

KNX function

Switching, rocker switch total	-	■
Switching, rocker switch left/right	-	■
Dimming, rocker switch total	-	■
Dimming, rocker switch left/right	-	■
Blind, rocker switch total	-	■
Blind, rocker switch total left/right	-	■
Short-long operation, rocker switch left/right	-	■
Value sender, rocker switch total	-	■
Value sender, rocker switch left/right	-	■
Value dimming sensor, rocker switch total	-	■
Red/green LED status illumination (red/green/off)	-	-
RGB LED function illumination + status illumination	-	1 LED per rocker switch
Setting the RTC operating mode	-	■
Value sender, 2 objects, rocker switch left/right	-	■
Light scene extension unit with light scene memory function	-	■
Level switch, rocker switch total	-	■
Level switch, rocker switch total left/right	-	■
Multiple operation, rocker switch left/right	-	■
IR remote control channels (up to 13 channels)	-	■
Light scene unit (8 scenes for up to 8 actuators)	-	-
Light scene unit (10 scenes for up to 10 actuators)	-	-
Programmable shift key	-	-
Proximity function	-	■

Room temperature controller only

Temperature reading	-	-
RTC settings	-	■
Illuminated display	-	■
Fan coil operation for heating and cooling	-	■

Media box/CD/DVD/radio	-	-
Short-time timer	-	-
Weekly timer	-	-
Alarm clock	-	-
Messages	-	-
Screen saver	-	-
Display text/value	-	■
Device lock	-	-

Logic function (including light scenes)	■	■
---	---	---

Busch-Watchdog 4 channels	■	-
---------------------------	---	---

■ = Function is supported

- = Function is not supported

ABB i-bus® KNX

User Operation – Design Ranges – Functional Overview

Program	Busch-priOn® suitable for KNX bus coupler 6120/12-101 or 6120/13 (depending on the specific combination)	
	6350-825-101 end strip top with IR receiver and proximity sensor	6352-xx-101 end strip bottom with temperature sensor
KNX function		
Switching, rocker switch total	-	-
Switching, rocker switch left/right	-	-
Dimming, rocker switch total	-	-
Dimming, rocker switch left/right	-	-
Blind, rocker switch total	-	-
Blind, rocker switch total left/right	-	-
Short-long operation, rocker switch left/right	-	-
Value sender, rocker switch total	-	-
Value sender, rocker switch left/right	-	-
Value dimming sensor, rocker switch total	-	-
Red/green LED status illumination (red/green/off)	-	-
RGB LED function illumination + status illumination	-	-
Setting the RTC operating mode	-	-
Value sender, 2 objects, rocker switch left/right	-	-
Light scene extension unit with light scene memory function	-	-
Level switch, rocker switch total	-	-
Level switch, rocker switch total left/right	-	-
Multiple operation, rocker switch left/right	-	-
IR remote control channels (up to 13 channels)	■	-
Light scene unit (8 scenes for up to 8 actuators)	-	-
Light scene unit (10 scenes for up to 10 actuators)	-	-
Programmable shift key	-	-
Proximity function	■	-
Room temperature controller only		
Temperature reading	-	■
RTC settings	-	-
Illuminated display	-	-
Fan coil operation for heating and cooling	-	-
Media box/CD/DVD/radio	-	-
Short-time timer	-	-
Weekly timer	-	-
Alarm clock	-	-
Messages	-	-
Screen saver	-	-
Display text/value	-	-
Device lock	-	-
Logic function (including light scenes)	-	-
Busch-Watchdog 4 channels	-	-

■ = Function is supported



- = Function is not supported

Program	Busch-triton® (next generation) Monoblock
	
	6320/10 1/2 gang 6320/30 3/6 gang 6320/50 5/10 gang
KNX function	
Switching, rocker switch total	■
Switching, rocker switch left/right	■
Dimming, rocker switch total	■
Dimming, rocker switch left/right	■
Blind, rocker switch total	■
Blind, rocker switch total left/right	■
Short-long operation, rocker switch left/right	■
Value sender, rocker switch total	■
Value sender, rocker switch left/right	■
Value dimming sensor, rocker switch total	■
Red/green LED status illumination (red/green/off)	1 LED per rocker switch
RGB LED function illumination + status illumination	-
Setting the RTC operating mode	■
Value sender, 2 objects, rocker switch left/right	■
Light scene extension unit with light scene memory function	■
Level switch, rocker switch total	■
Level switch, rocker switch total left/right	■
Multiple operation, rocker switch left/right	-
IR remote control channels (up to 13 channels)	■
Light scene unit (8 scenes for up to 8 actuators)	■
Light scene unit (10 scenes for up to 10 actuators)	-
Programmable shift key	■
Proximity function	-
Room temperature controller only	
Temperature reading	-
RTC settings	-
Illuminated display	-
Fan coil operation for heating and cooling	-
Media box/CD/DVD/radio	-
Short-time timer	-
Weekly timer	-
Alarm clock	-
Messages	-
Screen saver	-
Display text/value	-
Device lock	-
Logic function (including light scenes)	-
Busch-Watchdog 4 channels	-

—
 ■ = Function is supported
 - = Function is not supported



ABB i-bus® KNX

User Operation – Design Ranges – Functional Overview

Program	Millenium		
			
	6125/20-500 1/2 gang	6126/20-500 2/4 gang	6129/20-500 3/6 gang
KNX function			
Switching, button pair	■	■	■
Switching, button upper/lower	■	■	■
Dimming, button pair	■	■	■
Dimming, button upper/lower	■	■	■
Blind, button pair	■	■	■
Blind, button upper/lower	■	■	■
Short-long operation, button upper/lower	■	■	■
Value transmitter, button pair	■	■	■
Value transmitter, button upper/lower	■	■	■
Value dimming sensor, button pair	■	■	■
Value dimming sensor, upper/lower	■	■	■
RGB LED function illumination + status illumination	■	■	■
Setting the RTC operating mode	■	■	■
Value transmitter, 2 objects, button upper/lower	■	■	■
Light scene extension unit with light scene memory function	■	■	■
Step switch, button pair	■	■	■
Step switch, button upper/lower	■	■	■
Multiple operation, button upper/lower	■	■	■
IR remote control channels (up to 5 channels)	-	-	-
Room temperature controller only			
Temperature reading	-	-	-
RTC settings	-	-	-
Illuminated display	-	-	-
Fan coil operation for heating and cooling	-	-	-
10 logic channels (incl. light scene, actuator, sequence actuator, logic gates, etc.)	■	■	■
Busch-Watchdog 4 channels	-	-	-

■ = Function is supported

- = Function is not supported

Program	Millenium		
			
	6129/21-500 3/6 gang with IR	6122/20-500	6124/20-500
KNX function			
Switching, button pair	■	-	-
Switching, button upper/lower	■	-	-
Dimming, button pair	■	-	-
Dimming, button upper/lower	■	-	-
Blind, button pair	■	-	-
Blind, button upper/lower	■	-	-
Short-long operation, button upper/lower	■	-	-
Value transmitter, button pair	■	-	-
Value transmitter, button upper/lower	■	-	-
Value dimming sensor, button pair	■	-	-
Value dimming sensor, upper/lower	■	-	-
RGB LED function illumination + status illumination	■	-	-
Setting the RTC operating mode	■	-	-
Value transmitter, 2 objects, button upper/lower	■	-	-
Light scene extension unit with light scene memory function	■	-	-
Step switch, button pair	■	-	-
Step switch, button upper/lower	■	-	-
Multiple operation, button upper/lower	■	-	-
IR remote control channels (up to 5 channels)	■	-	-
Room temperature controller only			
Temperature reading	-	-	■
RTC settings	-	-	■
Illuminated display	-	-	■
Fan coil operation for heating and cooling	-	-	■
10 logic channels (incl. light scene, actuator, sequence actuator, logic gates, etc.)	■	-	■
Busch-Watchdog 4 channels	-	■	-



—

■ = Function is supported

- = Function is not supported



ABB i-bus® KNX

User Operation – Design Ranges – Functional Overview

Program	Zenit		
			
	6125/98-509 1/2 gang	6126/98-509 2/4 gang	6129/98-509 3/6 gang
KNX function			
Switching, button pair	■	■	■
Switching, button upper/lower	■	■	■
Dimming, button pair	■	■	■
Dimming, button upper/lower	■	■	■
Blind, button pair	■	■	■
Blind, button upper/lower	■	■	■
Short-long operation, button upper/lower	■	■	■
Value transmitter, button pair	■	■	■
Value transmitter, button upper/lower	■	■	■
Value dimming sensor, button pair	■	■	■
Value dimming sensor, upper/lower	■	■	■
RGB LED function illumination + status illumination	■	■	■
Setting the RTC operating mode	■	■	■
Value transmitter, 2 objects, button upper/lower	■	■	■
Light scene extension unit with light scene memory function	■	■	■
Step switch, button pair	■	■	■
Step switch, button upper/lower	■	■	■
Multiple operation, button upper/lower	■	■	■
IR remote control channels (up to 5 channels)	-	-	-
Room temperature controller only			
Temperature reading	-	-	-
RTC settings	-	-	-
Illuminated display	-	-	-
Fan coil operation for heating and cooling	-	-	-
10 logic channels (incl. light scene, actuator, sequence actuator, logic gates, etc.)	■	■	■
Busch-Watchdog 4 channels	-	-	-

■ = Function is supported

- = Function is not supported





Program	Zenit		
			
	6129/98-509 3/6 gang with IR	6122/98-509	6124/98-509
KNX function			
Switching, button pair	■	-	-
Switching, button upper/lower	■	-	-
Dimming, button pair	■	-	-
Dimming, button upper/lower	■	-	-
Blind, button pair	■	-	-
Blind, button upper/lower	■	-	-
Short-long operation, button upper/lower	■	-	-
Value transmitter, button pair	■	-	-
Value transmitter, button upper/lower	■	-	-
Value dimming sensor, button pair	■	-	-
Value dimming sensor, upper/lower	■	-	-
RGB LED function illumination + status illumination	■	-	-
Setting the RTC operating mode	■	-	-
Value transmitter, 2 objects, button upper/lower	■	-	-
Light scene extension unit with light scene memory function	■	-	-
Step switch, button pair	■	-	-
Step switch, button upper/lower	■	-	-
Multiple operation, button upper/lower	■	-	-
IR remote control channels (up to 5 channels)	■	-	-
Room temperature controller only			
Temperature reading	-	-	■
RTC settings	-	-	■
Illuminated display	-	-	■
Fan coil operation for heating and cooling	-	-	■
10 logic channels (incl. light scene, actuator, sequence actuator, logic gates, etc.)	■	-	■
Busch-Watchdog 4 channels	-	■	-

■ = Function is supported

- = Function is not supported





ABB i-bus® KNX

User Operation – Design Ranges – Functional Overview

Program	Multifunction control elements, suitable for KNX bus coupler 6120/12-101 and 6120/13			
				
	6125/02 1/2 gang 6126/02 2/4 gang 6127/02 4/8 gang	6129/01 3/6 gang with IR	6128/28 2/4 gang with RTC	6122/01 standard
KNX function				
Switching, rocker switch total	■	■	■	-
Switching, rocker switch left/right	■	■	■	-
Dimming, rocker switch total	■	■	■	-
Dimming, rocker switch left/right	■	■	■	-
Blind, rocker switch total	■	■	■	-
Venetian blind, rocker switch total left/right	■	■	■	-
Short-long operation, rocker switch left/right	■	■	■	-
Value sender, rocker switch total	■	■	■	-
Value sender, rocker switch left/right	■	■	■	-
Value dimming sensor, rocker switch total	■	■	■	-
Red/green LED status illumination (red/green/off)	-	-	-	-
RGB LED function illumination + status illumination	Two LEDs per rocker switch	Two LEDs per rocker switch	Two LEDs per rocker switch	-
Setting the RTC operating mode	■	■	■	-
Value sender, 2 objects, rocker switch left/right	■	■	■	-
Light scene extension unit with light scene memory function	■	■	■	-
Level switch, rocker switch total	■	■	■	-
Level switch, rocker switch total left/right	■	■	■	-
Multiple operation, rocker switch left/right	■	■	■	-
IR remote control channels (up to 5 channels)	-	■	-	-
Room temperature controller only				
Temperature reading	-	-	■	-
RTC settings	-	-	■	-
Illuminated display	-	-	■	-
Fan coil operation for heating and cooling	-	-	■	-
Logic function (including light scenes)	■	■	■	■
Busch-Watchdog 4 channels	-	-	-	■
ABB				
basic55®	-	-	-	-
future® linear	■	■	■	■
alpha exclusive/nea	-	-	-	-
Busch-axcent®	■	■	■	■
solo®	■	■	■	■
pure stainless steel	■	■	■	■
carat®	■	■	■	■
ocean®	-	-	-	-
All Weather 44	-	-	-	-

■ = Function is supported

- = Function is not supported



Program	FM Watchdog with integrated bus coupler	Standard control elements, bus coupler included with package	FM push-button coupling unit with integrated bus coupler	
				
	6122/10	6125/01 1 gang 6126/01 2 gang 6127/01 4 gang	6108/06 1/2 gang	6108/07 2/4 gang
KNX function				
Switching, rocker switch total	-	■	■	■
Switching, rocker switch left/right	-	-	■	■
Dimming, rocker switch total	-	■	■	■
Dimming, rocker switch left/right	-	-	■	■
Blind, rocker switch total	-	■	■	■
Venetian blind, rocker switch total left/right	-	-	■	■
Short-long operation, rocker switch left/right	-	-	■	■
Value sender, rocker switch total	-	■	■	■
Value sender, rocker switch left/right	-	-	■	■
Value dimming sensor, rocker switch total	-	-	■	■
Red/green LED status illumination (red/green/off)	-	Two LEDs per rocker switch	-	-
RGB LED function illumination + status illumination	-	-	One LED per rocker switch	One LED per rocker switch
Setting the RTC operating mode	-	-	■	■
Value sender, 2 objects, rocker switch left/right	-	■	■	■
Light scene extension unit with light scene memory function	-	■	■	■
Level switch, rocker switch total	-	-	■	■
Level switch, rocker switch total left/right	-	-	■	■
Multiple operation, rocker switch left/right	-	-	-	-
IR remote control channels (up to 5 channels)	-	-	-	-
Room temperature controller only				
Temperature reading	-	-	■	■
RTC settings	-	-	-	-
Illuminated display	-	-	-	-
Fan coil operation for heating and cooling	-	-	-	-
Logic function (including light scenes)	■	-	-	-
Busch-Watchdog 4 channels	■	-	-	-
ABB				
basic55®	-	-	■	■
future® linear	■	■	■	■
alpha exclusive/nea	-	-	-	-
Busch-axcent®	■	■	■	■
solo®	■	■	■	■
pure stainless steel	■	■	■	■
carat®	■	■	■	■
ocean®	-	-	-	-
All Weather 44	-	-	-	-

— = Function is supported

- = Function is not supported

ABB i-bus® KNX

User Operation – Design Ranges – Functional Overview

Program	FM push-button coupling unit with integrated bus coupler		
			
	6108/60 6-fold KNX sensor	6108/06-AP 1/2 gang	6108/07-AP 2/4 gang
KNX function			
Switching, rocker switch total	■	■	■
Switching, rocker switch left/right	-	■	■
Dimming, rocker switch total	■	■	■
Dimming, rocker switch left/right	-	■	■
Blind, rocker switch total	■	■	■
Venetian blind, rocker switch total left/right	-	■	■
Short-long operation, rocker switch left/right	-	■	■
Value sender, rocker switch total	■	■	■
Value sender, rocker switch left/right	-	■	■
Value dimming sensor, rocker switch total	■	■	■
Red/green LED status illumination (red/green/off)	-	1 LED	-
RGB LED function illumination + status illumination	-	-	-
Setting the RTC operating mode	-	■	■
Value sender, 2 objects, rocker switch left/right	-	■	■
Light scene extension unit with light scene memory function	■	■	■
Level switch, rocker switch total	■	■	■
Level switch, rocker switch total left/right	-	■	■
Multiple operation, rocker switch left/right	-	-	-
IR remote control channels (up to 5 channels)	-	-	-
Room temperature controller only			
Temperature reading	■	-	-
RTC settings	■ (only as slave)	-	-
Illuminated display	-	-	-
Fan coil operation for heating and cooling	■ (only as slave)	-	-
Logic function (including light scenes)			
Logic function (including light scenes)	-	-	-
Busch-Watchdog 4 channels			
Busch-Watchdog 4 channels	-	-	-
ABB			
basic55®	■	■	■
future® linear	■	■	■
alpha exclusive/nea	■	■	■
Busch-axcent®	■	■	■
solo®	■	■	■
pure stainless steel	■	■	■
carat®	■	■	■
ocean®	-	■	■
All Weather 44	-	■	■

■ = Function is supported





- = Function is not supported

Program	FM room temperature controller				
					
	6108/18	6109/18	6109/28	6109/08	6109/05
Control element					
Standard function	-	-	-	-	-
Additional function	-	-	-	-	-
Indication					
Display	■	■	■	-	-
Actual temperature display	■	■	■	-	-
Status display via text and/or ICON	-	■	■	-	-
RTC					
Manual operation	■	■	■	-	-
Heating and/or cooling with/without additional stage	■	■	■	■	■
Fan coil	■	■	■	■	■
Master/slave	■	■	■	master only	master only
Basic load	■	■	■	■	■
Internal and/or external actual temperature sensor	■	■	■	■	external only
Internal actual temperature sensor	■	■	■	■	■
Air quality					
CO ₂	-	-	■	-	-
Humidity	-	-	■	-	-
Air pressure	-	-	■	-	-
Universal input/binary input					
Switching/alarm	-	■	■	■	■
Dimming	-	■	■	■	■
Blind	-	■	■	■	■
Value	-	■	■	■	■
Scene	-	■	■	■	■
Switching sequences	-	■	■	■	■
Multi	-	■	■	■	■
Pulse counter	-	■	■	■	■
Universal analogue input e.g. external sensors					
0-10 V (external)	-	■	■	■	■
1-10 V (external)	-	■	■	■	■
Upper/lower threshold value	-	■	■	■	■
Universal input of external temperature sensor (PT1000 or 6226/T)					
Actual temperature sensor	-	■	■	■	■
Temperature limiter	-	■	■	■	■
ABB					
basic55®	■	■	■	■	-
future® linear	■	■	■	■	-
alpha exclusive/nea	-	■	■	■	-
Busch-axcent®	■	■	■	■	-
solo®	■	■	■	■	-
pure stainless steel	■	■	■	■	-
carat®	■	■	■	■	-
ocean®	-	-	-	-	-
All Weather 44	-	-	-	-	-

— = Function is not supported
 ■ = Function is supported



ABB i-bus® KNX

User Operation – Design Ranges – Functional Overview

Program		ABB tacteo®			
					
Square (vert.)	(86 mm x 86 mm)	TB/U1.1.1-CG	TB/U2.4.1-CG	TB/U4.4.1-CG	TB/U6.4.1-CG
Square (horiz.)	(86 mm x 86 mm)		TB/U2.5.1-CG	TB/U4.5.1-CG	TB/U6.5.1-CG
Vertical	(86 mm x 115 mm)	TB/U1.2.1-CG	TB/U2.7.1-CG	TB/U4.7.1-CG	TB/U6.7.1-CG
Horizontal	(115 mm x 86 mm)	TB/U1.3.1-CG	TB/U2.8.1-CG	TB/U4.8.1-CG	TB/U6.8.1-CG
Premium customization		TB/U1-CG	TB/U2-CG	TB/U4-CG	TB/U6-CG
Control element					
Standard function		■	■	■	■
Additional function		■	■	■	■
Indication					
Display		-	-	-	-
Actual temperature display		-	-	-	-
Status display via text and/or ICON		-	-	-	-
RTC					
Manual operation		-	-	-	-
Heating and/or cooling with/ without additional stage		-	-	-	-
Fan coil		-	-	-	-
Master/slave		-	-	-	-
Basic load		-	-	-	-
Internal and/or external actual temperature sensor		-	-	-	-
Internal actual temperature sensor		■	■	■	■
Installation					
VDE		■	■	■	■
BS		■	■	■	■
IT	(only as 115 mm x 86 mm)	■	■	■	■
NEMA	(only as 86 mm x 115 mm)	■	■	■	■

■ = Function is supported



- = Function is not supported

Program		ABB tacteo®		
				
Square (vert.)	(86 mm x 86 mm)	TR/U.1.1-CG	TBW/U.1.1-CG	TA/U3.1.1-CG
Square (horiz.)	(86 mm x 86 mm)			
Vertical	(86 mm x 115 mm)	TR/U.2.1-CG	TBW/U.2.1-CG	TA/U3.2.1-CG
Horizontal	(115 mm x 86 mm)	TR/U.3.1-CG	TBW/U.3.1-CG	TA/U3.3.1-CG
Premium customization		TR/U-CG	TBW/U-CG	TA/U3-CG
Control element				
Standard function		■	■	■
Additional function		■	■	-
Indication				
Display		■	-	-
Actual temperature display		■	-	-
Status display via text and/or ICON		■	-	-
RTC				
Manual operation		■	-	-
Heating and/or cooling with/ without additional stage		■	-	-
Fan coil		■	-	-
Master/slave		■	-	-
Basic load		■	-	-
Internal and/or external actual temperature sensor		■	-	-
Internal actual temperature sensor		■	■	■
Installation				
VDE		■	■	■
BS		■	■	■
IT	(only as 115 mm x 86 mm)	■	■	■
NEMA	(only as 86 mm x 115 mm)	■	■	■

—
 ■ = Function is supported
 - = Function is not supported

ABB i-bus® KNX

User Operation – Design Ranges – Functional Overview

Program		ABB tacteo®		
				
Vertical	(86 mm x 157 mm)	TB/U12.7.1-CG	TBR/U4.7.1-CG	TSN/U.2.1-CG
Horizontal	(157 mm x 86 mm)	TB/U12.8.1-CG	TBR/U4.8.1-CG	
Premium customization		TB/U12-CG	TBR/U4-CG	TSN/U-CG
Control element				
Standard function		■	■	■
Additional function		■	■	-
Indication				
Display		-	■	-
Actual temperature display		-	■	-
Status display via text and/or ICON		-	■	-
RTC				
Manual operation		-	■	-
Heating and/or cooling with/ without additional stage		-	■	-
Fan coil		-	■	-
Master/slave		-	■	-
Basic load		-	■	-
Internal and/or external actual temperature sensor		-	■	-
Internal actual temperature sensor		■	■	■
Installation				
VDE		■	■	■
BS		■	■	■
IT	(only as 157 mm x 86 mm)	-	-	■
NEMA	(only as 86 mm x 157 mm)	■	■	■







Program	ClimaECO			
	Control Elements	Operating function with RTC extension unit	Room temp. controller with oper. Function	RTC w. CO ₂ /humidety sens. a. oper. Function
				
	SB/U8.0.1-xxx SB/U12.0.1-xxx	SBS/U6.0.1-xxx SBS/U10.0.1-xxx	SBR/U6.0.1-xxx SBR/U10.0.1-xxx	SBC/U6.0.1-xxx SBC/U10.0.1-xxx
KNX function Switching, rocker switch total	■	■	■	■
Switching, rocker switch left/right	■	■	■	■
Dimming, rocker switch total	■	■	■	■
Dimming, rocker switch left/right	■	■	■	■
Blind switch rocker tota	■	■	■	■
Blind switch rocker total left/right	■	■	■	■
Short-long operation, switch rocker left/right	■	■	■	■
Value sender rocker switch total	■	■	■	■
Value sender switch rocker left/right	■	■	■	■
Value dimming sensor, switch rocker total	■	■	■	■
Red/green LED status illumination (red/green/off) 1 LED per switch rocker 1 LED per switch rocker	■	■	■	■
RGB LED function illumination + status illumination	■	■	■	■
1 LED per switch rocker	■	■	■	■
Setting the RTC operating mode	■	■	■	■
Value sender, 2 objects, rocker switch left/right	■	■	■	■
Light scene extension unit with light scene memory function	■	■	■	■
Level switch, switch rocker total	■	■	■	■
Level switch, switch rocker total left/right	■	■	■	■
Multiple operation, rocker switch left/right	■	■	■	■
IR remote control channels (up to 13 channels)				
Light scene unit (8 scenes for up to 8 actuators)	■	■	■	■
Light scene unit (10 scenes for up to 10 actuators)	■	■	■	■
Internal RTC function rocker total		■	■	■
Internal RTC function left/right		■	■	■
Programmable shift key				
Proximity function				
Room temperature controller			■	■
Temperature sensor	■	■	■	■
Master/Slave configuration			■	■
Slave configuration		■		
RTC settings			■	■
Base-load operation			■	■
Illuminated display		■	■	■
Fan Coil operation for heating and cooling		■	■	■
CO ₂ -Measurement				■
Humidety-Measurement				■
Dreupoint-management				■
Temperature				■
Device lock	■	■	■	■
Logic function (including light scenes)	■	■	■	■
Busch-Watchdog 4 channels				

ABB i-bus® KNX

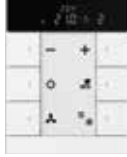
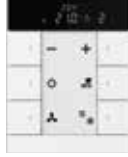
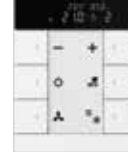
User Operation – Design Ranges – Functional Overview

Program	PEONIA®					
						
	PEB/U2.0.1-xxx	PEB/U3.0.1-xxx	PEB/U5.0.1-xxx	PEBR/U2.0.1-xxx	PEBR/U3.0.1-xxx	PEBR/U5.0.1-xxx
KNX function						
Switching, rocker switch total	■	■	■	■	■	■
Switching, rocker switch left/right	■	■	■	■	■	■
Dimming, rocker switch total	■	■	■	■	■	■
Dimming, rocker switch left/right	■	■	■	■	■	■
Blind switch rocker total	■	■	■	■	■	■
Blind switch rocker total left/right	■	■	■	■	■	■
Short-long operation, switch rocker left/right	■	■	■	■	■	■
Value sender rocker switch total	■	■	■	■	■	■
Value sender rocker switch left/right	■	■	■	■	■	■
RGB LED function illumination + Status illumination	■	■	■	■	■	■
RGB LED Ambient illumination	■	■	■	■	■	■
Setting the RTC operating mode	■	■	■	■	■	■
Value sender, 2 objects, rocker switch left/right	■	■	■	■	■	■
Light scene extension units with light scene memory function	■	■	■	■	■	■
Step switch, switch rocker total	■	■	■	■	■	■
Step switch, switch rocker left/right	■	■	■	■	■	■
Multiple operation, rocker switch left/right	■	■	■	■	■	■
Proximity function	■	■	■	■	■	■
Energy saving function	■	■	■	■	■	■
Dynamic display	-	-	-	■	■	■
Room temperature controller only						
RTC Capacitive touch button	-	-	-	■	■	■
Vibration feedback	-	-	-	■	■	■
Temperature reading	-	-	-	■	■	■
Single/Master/Slave configuration	-	-	-	■	■	■
RTC setting	-	-	-	■	■	■
Base-load operation	-	-	-	■	■	■
Illumination display	-	-	-	■	■	■
Fan coil operation or heating and cooling	-	-	-	■	■	■
5 Logic channels (incl. Priority, Logic gate, Staircase lighting, Delay, Min/max value transducer, Threshold value hysteresis, Light scene actuator)	■	■	■	■	■	■

■ = Function is supported

- = Function is not supported

PEONIA®

All in one for smarter life

PEONIA® is a highly smart panel integrated with lighting, temperature, electric doors and windows, air conditioning, floor heating, scene and proximity sensors. All these functions make your life smarter and easier than ever.



reddot award 2019
winner





A unique proximity sensor system that can automatically activate the background lights and scenario mode when you are close to the panel. In addition, the in-built sensor can monitor the temperature. Additional information like PM 2.5, VOC and humidity receive from the KNX bus can be displayed. This information can be displayed on the screen directly. When the air quality is bad, the sensor will open the window and air condition system automatically. This brings convenience and comfort to your daily life.

ABB i-bus® KNX

User Operation – Design Ranges – PEONIA®



PEBR/U2.0.1-201

PEONIA® control element 2/4-fold with Room Temperature Controller, FM

With integrated bus coupling unit and temperature sensor. Proximity sensor, device locking and energy saving function. Switch contact left/right. Replaceable rocker without icon. Push button function: switching/dimming/blind/value sending/step-type switch/lightscene/ fan function.

With base-load operation.

The controller is a constant room temperature controller for ventilator convectors (fan-coil) in 2 and 4 pipe system and conventional heating and cooling systems.

The fan stage can be switched manually or automatic mode.

Dedicated capacitive touch RTC control button with vibration feedback, Single/Master/Slave configuration.

LCD display: Setpoint/actual temperature, Fan speed, Operating state, Operating mode.

Configurable: time, PM2.5, CO₂, Humidity, VOC, temperature, Dynamic animation for dimming, blind, scene.

Individual programmable LED per rocker. Top and bottom ambient LED strip.

LED colour: red/green/yellow/blue/red-orange/violet/white.

Temperature range (device): -5 °C to 45 °C. Dimensions (L x W): 86 mm x 86 mm.

For British standard installation only.

Description	Mod. width	Order details		Price	Weight	Pack unit
		Type code	Order code	1 piece	1 piece	
				€	kg	pc.
Gloss White	-	PEBR/U2.0.1-002	2TAZ730210R0020		0.212	1
Matt White	-	PEBR/U2.0.1-001	2TAZ730210R0010		0.212	1
Matt Black	-	PEBR/U2.0.1-201	2TAZ730210R2010		0.212	1
Matt Silver	-	PEBR/U2.0.1-131	2TAZ730210R1310		0.212	1
Matt Platinum	-	PEBR/U2.0.1-151	2TAZ730210R1510		0.212	1
Matt Champagne Gold	-	PEBR/U2.0.1-411	2TAZ730210R4110		0.212	1



PEBR/U3.0.1-201

PEONIA® control element 3/6-fold with Room Temperature Controller, FM

With integrated bus coupling unit and temperature sensor.

Proximity sensor, device locking and energy saving function.

Switch contact left/right. Replaceable rocker without icon.

Push button function: switching/dimming/blind/value sending/step-type switch/lightscene/fan function. With base-load operation.

The controller is a constant room temperature controller for ventilator convectors (fan-coil) in 2 and 4 pipe system and conventional heating and cooling systems. The fan stage can be switched manually or automatic mode.

Delicated capacitive touch RTC control button with vibration feedback, Single/Master/Slave configuration.

LCD display: Setpoint/actual temperature, Fan speed, Operating state, Operating mode.

Configurable: time, PM2.5, CO₂, Humidity, VOC, temperature, Dynamic animation for dimming, blind, scene.

Individual programmable LED per rocker. Top and bottom ambient LED strip.

LED colour: red/green/yellow/blue/red-orange/violet/white.

Temperature range (device): -5 °C to 45 °C. Dimensions (L x W): 105 mm x 86 mm.

For British standard installation only.

Description	Mod. width	Order details		Price 1 piece	Weight 1 piece	Pack unit
		Type code	Order code			
Gloss White	-	PEBR/U3.0.1-002	2TAZ730310R0020		0.253	1
Matt White	-	PEBR/U3.0.1-001	2TAZ730310R0010		0.253	1
Matt Black	-	PEBR/U3.0.1-201	2TAZ730310R2010		0.253	1
Matt Silver	-	PEBR/U3.0.1-131	2TAZ730310R1310		0.253	1
Matt Platinum	-	PEBR/U3.0.1-151	2TAZ730310R1510		0.253	1
Matt Champagne Gold	-	PEBR/U3.0.1-411	2TAZ730310R4110		0.253	1

ABB i-bus® KNX

User Operation – Design Ranges – PEONIA®



PEBR/U5.0.1-201

PEONIA® control element 5/10-fold with Room Temperature Controller, FM

With integrated bus coupling unit and temperature sensor. Proximity sensor, device locking and energy saving function.

Switch contact left/right. Replaceable rocker without icon.

Push button function: switching/dimming/blind/value sending/step-type switch/lightscene/ fan function.

With base-load operation. The controller is a constant room temperature controller for ventilator convectors (fan-coil).

In 2 and 4 pipe system and conventional heating and cooling systems. The fan stage can be switched manually or automatic mode.

Dedicated capacitive touch RTC control button with vibration feedback, Single/Master/Slave configuration.

LCD display: Setpoint/actual temperature, Fan speed, Operating state, Operating mode.

Configurable: time, PM2.5, CO₂, Humidity, VOC, temperature, Dynamic animation for dimming, blind, scene.

Individual programmable LED per rocker. Top and bottom ambient LED strip.

LED colour: red/green/yellow/blue/red-orange/violet/white.

Temperature range (device): -5 °C to 45 °C. Dimensions (L x W): 141 mm x 86 mm.

For British standard installation only.

Description	Mod. width	Order details		Price 1 piece	Weight 1 piece	Pack unit
		Type code	Order code			
Gloss White	–	PEBR/U5.0.1-002	2TAZ730510R0020		0.284	1
Matt White	–	PEBR/U5.0.1-001	2TAZ730510R0010		0.284	1
Matt Black	–	PEBR/U5.0.1-201	2TAZ730510R2010		0.284	1
Matt Silver	–	PEBR/U5.0.1-131	2TAZ730510R1310		0.284	1
Matt Platinum	–	PEBR/U5.0.1-151	2TAZ730510R1510		0.284	1
Matt Champagne Gold	–	PEBR/U5.0.1-411	2TAZ730510R4110		0.284	1



PEB/U2.0.1-201

PEONIA® control element 2/4-fold, FM

With integrated bus coupling unit and temperature sensor.
 Proximity sensor, device locking and energy saving function.
 Switch contact left/right. Replaceable rocker without icon.
 Push button function: switching/dimming/blind/value sending/step-type switch/lightscene.
 Individual programmable LED per rocker. Top and bottom ambient LED strip.
 LED colour: red/green/yellow/blue/red-orange/violet/white.
 Dimensions (L x W): 86 mm x 86 mm.
 For British standard installation only.

Description	Mod. width	Order details		Price	Weight	Pack
		Type code	Order code	1 piece	1 piece	unit
				€	kg	pc.
Gloss White	–	PEB/U2.0.1-002	2TAZ730200R0020		0.204	1
Matt White	–	PEB/U2.0.1-001	2TAZ730200R0010		0.204	1
Matt Black	–	PEB/U2.0.1-201	2TAZ730200R2010		0.204	1
Matt Silver	–	PEB/U2.0.1-131	2TAZ730200R1310		0.204	1
Matt Platinum	–	PEB/U2.0.1-151	2TAZ730200R1510		0.204	1
Matt Champagne Gold	–	PEB/U2.0.1-411	2TAZ730200R4110		0.204	1



PEB/U3.0.1-201

PEONIA® control element 3/6-fold, FM

With integrated bus coupling unit and temperature sensor.
 Proximity sensor, device locking and energy saving function.
 Switch contact left/right. Replaceable rocker without icon.
 Push button function: switching/dimming/blind/value sending/step-type switch/lightscene.
 Individual programmable LED per rocker. Top and bottom ambient LED strip.
 LED colour: red/green/yellow/blue/red-orange/violet/white.
 Dimensions (L x W): 86 mm x 86 mm.
 For British standard installation only.

Description	Mod. width	Order details		Price	Weight	Pack
		Type code	Order code	1 piece	1 piece	unit
				€	kg	pc.
Gloss White	–	PEB/U3.0.1-002	2TAZ730300R0020		0.205	1
Matt White	–	PEB/U3.0.1-001	2TAZ730300R0010		0.205	1
Matt Black	–	PEB/U3.0.1-201	2TAZ730300R2010		0.205	1
Matt Silver	–	PEB/U3.0.1-131	2TAZ730300R1310		0.205	1
Matt Platinum	–	PEB/U3.0.1-151	2TAZ730300R1510		0.205	1
Matt Champagne Gold	–	PEB/U3.0.1-411	2TAZ730300R4110		0.205	1

ABB i-bus® KNX

User Operation – Design Ranges – PEONIA®



PEB/U5.0.1-201

PEONIA® control element 5/10-fold, FM

With integrated bus coupling unit and temperature sensor.
 Proximity sensor, device locking and energy saving function.
 Switch contact left/right. Replaceable rocker without icon.
 Push button function: switching/dimming/blind/value sending/step-type switch/lightscene.
 Individual programmable LED per rocker. Top and bottom ambient LED strip.
 LED colour: red/green/yellow/blue/red-orange/violet/white.
 Dimensions (L x W): 144 mm x 86 mm.
 For British standard installation only.

Description	Mod. width	Order details		Price	Weight	Pack
		Type code	Order code	1 piece	1 piece	unit
			€	kg	pc.	
Gloss White	–	PEB/U5.0.1-002	2TAZ730500R0020		0.275	1
Matt White	–	PEB/U5.0.1-001	2TAZ730500R0010		0.275	1
Matt Black	–	PEB/U5.0.1-201	2TAZ730500R2010		0.275	1
Matt Silver	–	PEB/U5.0.1-131	2TAZ730500R1310		0.275	1
Matt Platinum	–	PEB/U5.0.1-151	2TAZ730500R1510		0.275	1
Matt Champagne Gold	–	PEB/U5.0.1-411	2TAZ730500R4110		0.275	1



PESX/2.10.1-201

Replaceable rocker without icon for PEONIA® control element, PEB/U2.0.1-xxx

Dimensions (L x W): 43 mm x 78 mm.
 For British standard installation only.

Description	Mod. width	Order details		Price	Weight	Pack
		Type code	Order code	1 piece	1 piece	unit
			€	kg	pc.	
Gloss White	–	PESX/2.10.1-002	2TAZ730000R0020		0.087	1
Matt White	–	PESX/2.10.1-001	2TAZ730000R0010		0.087	1
Matt Black	–	PESX/2.10.1-201	2TAZ730000R2010		0.087	1
Matt Silver	–	PESX/2.10.1-131	2TAZ730000R1310		0.087	1
Matt Platinum	–	PESX/2.10.1-151	2TAZ730000R1510		0.087	1
Matt Champagne Gold	–	PESX/2.10.1-411	2TAZ730000R4110		0.087	1



PESB/2.10.1-201

Replaceable rocker with lighting icon for PEONIA® control element, PEB/U2.0.1-xxx

Dimensions (L x W): 43 mm x 78 mm.
 For British standard installation only.

Description	Mod. width	Order details		Price	Weight	Pack
		Type code	Order code	1 piece	1 piece	unit
			€	kg	pc.	
Gloss White	–	PESB/2.10.1-002	2TAZ730000R0021		0.087	1
Matt White	–	PESB/2.10.1-001	2TAZ730000R0011		0.087	1
Matt Black	–	PESB/2.10.1-201	2TAZ730000R2011		0.087	1
Matt Silver	–	PESB/2.10.1-131	2TAZ730000R1311		0.087	1
Matt Platinum	–	PESB/2.10.1-151	2TAZ730000R1511		0.087	1
Matt Champagne Gold	–	PESB/2.10.1-411	2TAZ730000R4111		0.087	1



PESD/2.10.1-201

Replaceable rocker with dimming icon for PEONIA® control element, PEB/U2.0.1-xxx

Dimensions (L x W): 43 mm x 78 mm.

For British standard installation only.

Description	Mod. width	Order details		Price	Weight	Pack
		Type code	Order code	1 piece	1 piece	unit
			€	kg	pc.	
Gloss White	–	PESD/2.10.1-002	2TAZ730000R0024		0.087	1
Matt White	–	PESD/2.10.1-001	2TAZ730000R0014		0.087	1
Matt Black	–	PESD/2.10.1-201	2TAZ730000R2014		0.087	1
Matt Silver	–	PESD/2.10.1-131	2TAZ730000R1314		0.087	1
Matt Platinum	–	PESD/2.10.1-151	2TAZ730000R1514		0.087	1
Matt Champagne Gold	–	PESD/2.10.1-411	2TAZ730000R4114		0.087	1



PESJ/2.10.1-201

Replaceable rocker with blind icon for PEONIA® control element, PEB/U2.0.1-xxx

Dimensions (L x W): 43 mm x 78 mm.

For British standard installation only.

Description	Mod. width	Order details		Price	Weight	Pack
		Type code	Order code	1 piece	1 piece	unit
			€	kg	pc.	
Gloss White	–	PESJ/2.10.1-002	2TAZ730000R0023		0.087	1
Matt White	–	PESJ/2.10.1-001	2TAZ730000R0013		0.087	1
Matt Black	–	PESJ/2.10.1-201	2TAZ730000R2013		0.087	1
Matt Silver	–	PESJ/2.10.1-131	2TAZ730000R1313		0.087	1
Matt Platinum	–	PESJ/2.10.1-151	2TAZ730000R1513		0.087	1
Matt Champagne Gold	–	PESJ/2.10.1-411	2TAZ730000R4113		0.087	1



PESR/2.10.1-201

Replaceable rocker with temperature icon for PEONIA® control element, PEB/U2.0.1-xxx

Dimensions (L x W): 43 mm x 78 mm.

For British standard installation only.

Description	Mod. width	Order details		Price	Weight	Pack
		Type code	Order code	1 piece	1 piece	unit
			€	kg	pc.	
Gloss White	–	PESR/2.10.1-002	2TAZ730000R0022		0.087	1
Matt White	–	PESR/2.10.1-001	2TAZ730000R0012		0.087	1
Matt Black	–	PESR/2.10.1-201	2TAZ730000R2012		0.087	1
Matt Silver	–	PESR/2.10.1-131	2TAZ730000R1312		0.087	1
Matt Platinum	–	PESR/2.10.1-151	2TAZ730000R1512		0.087	1
Matt Champagne Gold	–	PESR/2.10.1-411	2TAZ730000R4112		0.087	1

ABB i-bus® KNX

User Operation – Design Ranges – PEONIA®



PESF/2.10.1-201

Replaceable rocker with fan icon for PEONIA® control element, PEB/U2.0.1-xxx

Dimensions (L x W): 43 mm x 78 mm.

For British standard installation only.

Description	Mod. width	Order details		Price	Weight	Pack
		Type code	Order code	1 piece	1 piece	unit
				€	kg	pc.
Gloss White	–	PESF/2.10.1-002	2TAZ730000R0025		0.087	1
Matt White	–	PESF/2.10.1-001	2TAZ730000R0015		0.087	1
Matt Black	–	PESF/2.10.1-201	2TAZ730000R2015		0.087	1
Matt Silver	–	PESF/2.10.1-131	2TAZ730000R1315		0.087	1
Matt Platinum	–	PESF/2.10.1-151	2TAZ730000R1515		0.087	1
Matt Champagne Gold	–	PESF/2.10.1-411	2TAZ730000R4115		0.087	1



PESZ/2.10.1-201

Replaceable rocker with scene icon for PEONIA® control element, PEB/U2.0.1-xxx

Dimensions (L x W): 43 mm x 78 mm.

For British standard installation only.

Description	Mod. width	Order details		Price	Weight	Pack
		Type code	Order code	1 piece	1 piece	unit
				€	kg	pc.
Gloss White	–	PESZ/2.10.1-002	2TAZ730000R0026		0.087	1
Matt White	–	PESZ/2.10.1-001	2TAZ730000R0016		0.087	1
Matt Black	–	PESZ/2.10.1-201	2TAZ730000R2016		0.087	1
Matt Silver	–	PESZ/2.10.1-131	2TAZ730000R1316		0.087	1
Matt Platinum	–	PESZ/2.10.1-151	2TAZ730000R1516		0.087	1
Matt Champagne Gold	–	PESZ/2.10.1-411	2TAZ730000R4116		0.087	1



PESX/35.10.1-201

Replaceable rocker without icon for PEONIA® control element, PEB/U3.0.1-xxx, PEB/U5.0.1-xxx

Dimensions (L x W): 29 mm x 78 mm.

For British standard installation only.

Description	Mod. width	Order details		Price	Weight	Pack
		Type code	Order code	1 piece	1 piece	unit
				€	kg	pc.
Gloss White	–	PESX/35.10.1-002	2TAZ730001R0020		0.074	1
Matt White	–	PESX/35.10.1-001	2TAZ730001R0010		0.074	1
Matt Black	–	PESX/35.10.1-201	2TAZ730001R2010		0.074	1
Matt Silver	–	PESX/35.10.1-131	2TAZ730001R1310		0.074	1
Matt Platinum	–	PESX/35.10.1-151	2TAZ730001R1510		0.074	1
Matt Champagne Gold	–	PESX/35.10.1-411	2TAZ730001R4110		0.074	1



PESB/35.10.1-201

**Replaceable rocker with lighting icon for PEONIA® control element,
PEB/U3.0.1-xxx, PEB/U5.0.1-xxx**

Dimensions (L x W): 29 mm x 78 mm.

For British standard installation only.

Description	Mod. width	Order details		Price	Weight	Pack
		Type code	Order code	1 piece	1 piece	unit
			€	kg	pc.	
Gloss White	–	PESB/35.10.1-002	2TAZ730001R0021		0.074	1
Matt White	–	PESB/35.10.1-001	2TAZ730001R0011		0.074	1
Matt Black	–	PESB/35.10.1-201	2TAZ730001R2011		0.074	1
Matt Silver	–	PESB/35.10.1-131	2TAZ730001R1311		0.074	1
Matt Platinum	–	PESB/35.10.1-151	2TAZ730001R1511		0.074	1
Matt Champagne Gold	–	PESB/35.10.1-411	2TAZ730001R4111		0.074	1



PESD/35.10.1-201

**Replaceable rocker with dimming icon for PEONIA® control element,
PEB/U3.0.1-xxx, PEB/U5.0.1-xxx**

Dimensions (L x W): 29 mm x 78 mm.

For British standard installation only.

Description	Mod. width	Order details		Price	Weight	Pack
		Type code	Order code	1 piece	1 piece	unit
			€	kg	pc.	
Gloss White	–	PESD/35.10.1-002	2TAZ730001R0024		0.074	1
Matt White	–	PESD/35.10.1-001	2TAZ730001R0014		0.074	1
Matt Black	–	PESD/35.10.1-201	2TAZ730001R2014		0.074	1
Matt Silver	–	PESD/35.10.1-131	2TAZ730001R1314		0.074	1
Matt Platinum	–	PESD/35.10.1-151	2TAZ730001R1514		0.074	1
Matt Champagne Gold	–	PESD/35.10.1-411	2TAZ730001R4114		0.074	1



PESJ/35.10.1-201

**Replaceable rocker with blind icon for PEONIA® control element,
PEB/U3.0.1-xxx, PEB/U5.0.1-xxx**

Dimensions (L x W): 29 mm x 78 mm.

For British standard installation only.

Description	Mod. width	Order details		Price	Weight	Pack
		Type code	Order code	1 piece	1 piece	unit
			€	kg	pc.	
Gloss White	–	PESJ/35.10.1-002	2TAZ730001R0023		0.074	1
Matt White	–	PESJ/35.10.1-001	2TAZ730001R0013		0.074	1
Matt Black	–	PESJ/35.10.1-201	2TAZ730001R2013		0.074	1
Matt Silver	–	PESJ/35.10.1-131	2TAZ730001R1313		0.074	1
Matt Platinum	–	PESJ/35.10.1-151	2TAZ730001R1513		0.074	1
Matt Champagne Gold	–	PESJ/35.10.1-411	2TAZ730001R4113		0.074	1

ABB i-bus® KNX

User Operation – Design Ranges – PEONIA®



PESR/35.10.1-201

Replaceable rocker with temperature icon for PEONIA® control element, PEB/U3.0.1-xxx, PEB/U5.0.1-xxx

Dimensions (L x W): 29 mm x 78 mm.

For British standard installation only.

Description	Mod. width	Order details		Price	Weight	Pack unit
		Type code	Order code	1 piece	1 piece	
				€	kg	pc.
Gloss White	–	PESR/35.10.1-002	2TAZ730001R0022		0.074	1
Matt White	–	PESR/35.10.1-001	2TAZ730001R0012		0.074	1
Matt Black	–	PESR/35.10.1-201	2TAZ730001R2012		0.074	1
Matt Silver	–	PESR/35.10.1-131	2TAZ730001R1312		0.074	1
Matt Platinum	–	PESR/35.10.1-151	2TAZ730001R1512		0.074	1
Matt Champagne Gold	–	PESR/35.10.1-411	2TAZ730001R4112		0.074	1



PESF/35.10.1-201

Replaceable rocker with fan icon for PEONIA® control element, PEB/U3.0.1-xxx, PEB/U5.0.1-xxx

Dimensions (L x W): 29 mm x 78 mm.

For British standard installation only.

Description	Mod. width	Order details		Price	Weight	Pack unit
		Type code	Order code	1 piece	1 piece	
				€	kg	pc.
Gloss White	–	PESF/35.10.1-002	2TAZ730001R0025		0.074	1
Matt White	–	PESF/35.10.1-001	2TAZ730001R0015		0.074	1
Matt Black	–	PESF/35.10.1-201	2TAZ730001R2015		0.074	1
Matt Silver	–	PESF/35.10.1-131	2TAZ730001R1315		0.074	1
Matt Platinum	–	PESF/35.10.1-151	2TAZ730001R1515		0.074	1
Matt Champagne Gold	–	PESF/35.10.1-411	2TAZ730001R4115		0.074	1



PESZ/35.10.1-201

Replaceable rocker with scene icon for PEONIA® control element, PEB/U3.0.1-xxx, PEB/U5.0.1-xxx

Dimensions (L x W): 29 mm x 78 mm.

For British standard installation only.

Description	Mod. width	Order details		Price	Weight	Pack unit
		Type code	Order code	1 piece	1 piece	
				€	kg	pc.
Gloss White	–	PESZ/35.10.1-002	2TAZ730001R0026		0.074	1
Matt White	–	PESZ/35.10.1-001	2TAZ730001R0016		0.074	1
Matt Black	–	PESZ/35.10.1-201	2TAZ730001R2016		0.074	1
Matt Silver	–	PESZ/35.10.1-131	2TAZ730001R1316		0.074	1
Matt Platinum	–	PESZ/35.10.1-151	2TAZ730001R1516		0.074	1
Matt Champagne Gold	–	PESZ/35.10.1-411	2TAZ730001R4116		0.074	1



PESX/235.10.1-201

Replaceable rocker without icon for PEONIA® control element, PEBR/Ux.0.1-xxx

Dimensions (L x W): 18 mm x 78 mm.

For British standard installation only.

Description	Mod. width	Order details		Price	Weight	Pack unit
		Type code	Order code	1 piece	1 piece	
				€	kg	pc.
Gloss White	–	PESX/235.10.1-002	2TAZ730010R0020		0.065	1
Matt White	–	PESX/235.10.1-001	2TAZ730010R0010		0.065	1
Matt Black	–	PESX/235.10.1-201	2TAZ730010R2010		0.065	1
Matt Silver	–	PESX/235.10.1-131	2TAZ730010R1310		0.065	1
Matt Platinum	–	PESX/235.10.1-151	2TAZ730010R1510		0.065	1
Matt Champagne Gold	–	PESX/235.10.1-411	2TAZ730010R4110		0.065	1



PESB/235.10.1-201

Replaceable rocker with lighting icon for PEONIA® control element, PEBR/Ux.0.1-xxx

Dimensions (L x W): 18 mm x 78 mm.

For British standard installation only.

Description	Mod. width	Order details		Price	Weight	Pack unit
		Type code	Order code	1 piece	1 piece	
				€	kg	pc.
Gloss White	–	PESB/235.10.1-002	2TAZ730010R0021		0.065	1
Matt White	–	PESB/235.10.1-001	2TAZ730010R0011		0.065	1
Matt Black	–	PESB/235.10.1-201	2TAZ730010R2011		0.065	1
Matt Silver	–	PESB/235.10.1-131	2TAZ730010R1311		0.065	1
Matt Platinum	–	PESB/235.10.1-151	2TAZ730010R1511		0.065	1
Matt Champagne Gold	–	PESB/235.10.1-411	2TAZ730010R4111		0.065	1



PESD/235.10.1-201

Replaceable rocker with dimming icon for PEONIA® control element, PEBR/Ux.0.1-xxx

Dimensions (L x W): 18 mm x 78 mm.

For British standard installation only.

Description	Mod. width	Order details		Price	Weight	Pack unit
		Type code	Order code	1 piece	1 piece	
				€	kg	pc.
Gloss White	–	PESD/235.10.1-002	2TAZ730010R0024		0.065	1
Matt White	–	PESD/235.10.1-001	2TAZ730010R0014		0.065	1
Matt Black	–	PESD/235.10.1-201	2TAZ730010R2014		0.065	1
Matt Silver	–	PESD/235.10.1-131	2TAZ730010R1314		0.065	1
Matt Platinum	–	PESD/235.10.1-151	2TAZ730010R1514		0.065	1
Matt Champagne Gold	–	PESD/235.10.1-411	2TAZ730010R4114		0.065	1

ABB i-bus® KNX

User Operation – Design Ranges – PEONIA®



PESJ/235.10.1-201

Replaceable rocker with blind icon for PEONIA® control element, PEBR/Ux.0.1-xxx

Dimensions (L x W): 18 mm x 78 mm.

For British standard installation only.

Description	Mod. width	Order details		Price	Weight	Pack
		Type code	Order code	1 piece	1 piece	unit
				€	kg	pc.
Gloss White	–	PESJ/235.10.1-002	2TAZ730010R0023		0.065	1
Matt White	–	PESJ/235.10.1-001	2TAZ730010R0013		0.065	1
Matt Black	–	PESJ/235.10.1-201	2TAZ730010R2013		0.065	1
Matt Silver	–	PESJ/235.10.1-131	2TAZ730010R1313		0.065	1
Matt Platinum	–	PESJ/235.10.1-151	2TAZ730010R1513		0.065	1
Matt Champagne Gold	–	PESJ/235.10.1-411	2TAZ730010R4113		0.065	1



PESR/235.10.1-201

Replaceable rocker with temperature icon for PEONIA® control element, PEBR/Ux.0.1-xxx

Dimensions (L x W): 18 mm x 78 mm.

For British standard installation only.

Description	Mod. width	Order details		Price	Weight	Pack
		Type code	Order code	1 piece	1 piece	unit
				€	kg	pc.
Gloss White	–	PESR/235.10.1-002	2TAZ730010R0022		0.065	1
Matt White	–	PESR/235.10.1-001	2TAZ730010R0012		0.065	1
Matt Black	–	PESR/235.10.1-201	2TAZ730010R2012		0.065	1
Matt Silver	–	PESR/235.10.1-131	2TAZ730010R1312		0.065	1
Matt Platinum	–	PESR/235.10.1-151	2TAZ730010R1512		0.065	1
Matt Champagne Gold	–	PESR/235.10.1-411	2TAZ730010R4112		0.065	1



PESF/235.10.1-201

Replaceable rocker with fan icon for PEONIA® control element, PEBR/Ux.0.1-xxx

Dimensions (L x W): 18 mm x 78 mm.

For British standard installation only.

Description	Mod. width	Order details		Price	Weight	Pack
		Type code	Order code	1 piece	1 piece	unit
				€	kg	pc.
Gloss White	–	PESF/235.10.1-002	2TAZ730010R0025		0.065	1
Matt White	–	PESF/235.10.1-001	2TAZ730010R0015		0.065	1
Matt Black	–	PESF/235.10.1-201	2TAZ730010R2015		0.065	1
Matt Silver	–	PESF/235.10.1-131	2TAZ730010R1315		0.065	1
Matt Platinum	–	PESF/235.10.1-151	2TAZ730010R1515		0.065	1
Matt Champagne Gold	–	PESF/235.10.1-411	2TAZ730010R4115		0.065	1



PESZ/235.10.1-201

Replaceable rocker with scene icon for PEONIA® control element, PEBR/Ux.0.1-xxx

Dimensions (L x W): 18 mm x 78 mm.

For British standard installation only.

Description	Mod. width	Order details		Price	Weight	Pack
		Type code	Order code	1 piece	1 piece	unit
				€	kg	pc.
Gloss White	-	PESZ/235.10.1-002	2TAZ730010R0026		0.065	1
Matt White	-	PESZ/235.10.1-001	2TAZ730010R0016		0.065	1
Matt Black	-	PESZ/235.10.1-201	2TAZ730010R2016		0.065	1
Matt Silver	-	PESZ/235.10.1-131	2TAZ730010R1316		0.065	1
Matt Platinum	-	PESZ/235.10.1-151	2TAZ730010R1516		0.065	1
Matt Champagne Gold	-	PESZ/235.10.1-411	2TAZ730010R4116		0.065	1

A smart sensor for everything

Advantages for you at a glance



—
The extra-flat KNX sensor fits into any environment

Flat and theft-proof

The frameless and extra-flat KNX sensor with a diameter of 9.5 mm sits almost flush with the wall and blends harmoniously into any wall design.

Peace of mind is provided by the optional removal guard, which protects the KNX sensor from theft.



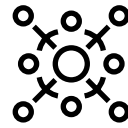

Secure access control for the hospitality industry

Hotel access control

The ABB tacteo® KNX range offers secure access control for the hospitality industry. It is particularly practical that the sensor performs all of a hotel's management tasks, which can be controlled from a central point such as the reception desk.



The capacitive glass sensors react without contact

Intuitive operation

The capacitive KNX glass sensors react without any touch or contact. When moving your hand towards the sensor, the status lighting switches on automatically. On the other hand, touching the sensor with the entire palm of your hand triggers a preprogrammed function – such as “switching on the light”. With a tap of the finger the desired function can be activated. Easy operation is also ensured by the tried-and-tested colour control concept.





ABB tacteo® KNX

The individual touch

Unique in design and function, the intuitive and individually configurable ABB tacteo® KNX sensor is as extraordinary as you are. The impressive, high-quality black or white glass sensor with its capacitive user interface offers virtually unlimited possibilities for intelligent building networking. Heating, ventilation, blinds and lighting can all be controlled to create comfortable everyday situations and put intelligent building management firmly in your hands. Discover more details at abb.com/tacteo



ABB i-bus® KNX

User Operation – Design Ranges – ABB tacteo®

Touch Control Element with Bus Coupler, FM

Freely configurable multifunction control element. The icons and/or texts are configured by means of a web configuration tool. With integrated KNX bus coupler. With integrated temperature sensor and proximity function. Push switch function: switching / dimming / blind / sending values / scenes etc. Support of KNX functions through innovative colour concept (yellow=lighting, blue=blind, orange=RTC, magenta=scene and white=neutral/no function assigned) or standard illumination red/green. The bus connection is provided via the enclosed bus terminal.

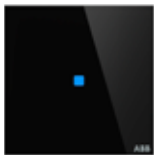

TB/U1.1.1-CG

1-fold

Description	Standard Design ID	Order details		Price 1 piece	Dimensions	Pack unit
		Type code	Order code			
Standard customization ¹⁾	Go to configurator	TB/U1.1.1-CG	2CKA006300A1538	€	86x86 mm	1 pc.
Premium customization ¹⁾	Go to configurator	TB/U1-CG	2CKA006300A1641	€	86x86 mm	1 pc.



TB/U2.4.1-CG

2-fold

Description	Standard Design ID	Order details		Price 1 piece	Dimensions	Pack unit
		Type code	Order code			
Standard customization ¹⁾	Go to configurator	TB/U2.4.1-CG	2CKA006300A1539	€	86x86 mm	1 pc.
Premium customization ¹⁾	Go to configurator	TB/U2-CG	2CKA006300A1642	€	86x86 mm	1 pc.



TB/U2.5.1-CG

2-fold

Description	Standard Design ID	Order details		Price 1 piece	Dimensions	Pack unit
		Type code	Order code			
Standard customization ¹⁾	Go to configurator	TB/U2.5.1-CG	2CKA006300A1540	€	86x86 mm	1 pc.
Premium customization ¹⁾	Go to configurator	TB/U2-CG	2CKA006300A1642	€	86x86 mm	1 pc.



TB/U4.4.1-CG

4-fold

Description	Standard Design ID	Order details		Price 1 piece	Dimensions	Pack unit
		Type code	Order code			
Standard customization ¹⁾	Go to configurator	TB/U4.4.1-CG	2CKA006300A1541	€	86x86 mm	1 pc.
Premium customization ¹⁾	Go to configurator	TB/U4-CG	2CKA006300A1643	€	86x86 mm	1 pc.

¹⁾ The individual design can be selected via the website:

URL: <https://tacteo-configurator.eu.mybuildings.abb.com/>

ABB i-bus® KNX

User Operation – Design Ranges – ABB tacteo®



TB/U4.5.1-CG

4-fold

Description	Standard Design ID	Order details		Price 1 piece	Dimensions	Pack unit
		Type code	Order code			
Standard customization ¹⁾	Go to configurator	TB/U4.5.1-CG	2CKA006300A1612	€	86x86 mm	1 pc.
Premium customization ¹⁾	Go to configurator	TB/U4-CG	2CKA006300A1643	€	86x86 mm	1 pc.



TB/U6.4.1-CG

6-fold

Description	Standard Design ID	Order details		Price 1 piece	Dimensions	Pack unit
		Type code	Order code			
Standard customization ¹⁾	Go to configurator	TB/U6.4.1-CG	2CKA006300A1542	€	86x86 mm	1 pc.
Premium customization ¹⁾	Go to configurator	TB/U6-CG	2CKA006300A1644	€	86x86 mm	1 pc.



TB/U6.5.1-CG

6-fold

Description	Standard Design ID	Order details		Price 1 piece	Dimensions	Pack unit
		Type code	Order code			
Standard customization ¹⁾	Go to configurator	TB/U6.5.1-CG	2CKA006300A1602	€	86x86 mm	1 pc.
Premium customization ¹⁾	Go to configurator	TB/U6-CG	2CKA006300A1644	€	86x86 mm	1 pc.



TB/U12.7.1-CG

12-fold

Description	Standard Design ID	Order details		Price 1 piece	Dimensions	Pack unit
		Type code	Order code			
Standard customization ¹⁾	Go to configurator	TB/U12.7.1-CG	2CKA006300A1543	€	86x157 mm	1 pc.
Premium customization ¹⁾	Go to configurator	TB/U12-CG	2CKA006300A1645	€	86x157 mm	1 pc.



TB/U12.8.1-CG

12-fold

Description	Standard Design ID	Order details		Price 1 piece	Dimensions	Pack unit
		Type code	Order code			
Standard customization ¹⁾	Go to configurator	TB/U12.8.1-CG	2CKA006300A1544	€	157x86 mm	1 pc.
Premium customization ¹⁾	Go to configurator	TB/U12-CG	2CKA006300A1645	€	157x86 mm	1 pc.

¹⁾ The individual design can be selected via the website:

URL: <https://tacteo-configurator.eu.mybuildings.abb.com/>



TBR/U4.7.1-CG



TBR/U4.8.1-CG



TR/U.1.1-CG

Touch Control Element with Room Temperature Controller and Bus Coupler, 4-fold, FM

Freely configurable multifunction control element. The icons and/or texts are configured by means of a web configuration tool. Support of KNX functions through innovative colour concept (yellow=lighting, blue=blind, orange=RTC, magenta=scene and white=neutral/no function assigned) or standard illumination red/green. Rocker switch left/right (switching/dimming/blind/value sender/light scenes/fan function). The controller is a constant room temperature controller for ventilator convectors (fan coils) in 2-pipe and 4-pipe systems and conventional heating or cooling systems. The fan stage can be switched manually or in automatic mode. Class of temperature controller 1. Contribution to space heating energy efficiency 1,0 %. With integrated KNX bus coupler.

Description	Standard Design ID	Order details		Price 1 piece	Dimensions mm	Pack unit pc.
		Type code	Order code			
Standard customization ¹⁾	Go to configurator	TBR/U4.7.1-CG	2CKA006300A1545		86x157	1
Premium customization ¹⁾	Go to configurator	TBR/U4-CG	2CKA006300A1648		86x157	1
Standard customization ¹⁾	Go to configurator	TBR/U4.8.1-CG	2CKA006300A1546		157x86	1
Premium customization ¹⁾	Go to configurator	TBR/U4-CG	2CKA006300A1648		157x86	1

Touch Room Temperature Controller with Bus Coupler, FM

Ordering possible only in connection with the design ID. The icons and/or texts are configured by means of a web configuration tool. Support of KNX functions through innovative colour concept (yellow=lighting, blue=blind, orange=RTC, magenta=scene and white=neutral/no function assigned) or standard illumination red/green. The controller is a constant room temperature controller for ventilator convectors (fan coils) in 2-pipe and 4-pipe systems and conventional heating or cooling systems. The fan stage can be switched manually or in automatic mode. Class of temperature controller 1. Contribution to space heating energy efficiency 1,0 %. With integrated KNX bus coupler.

Description	Standard Design ID	Order details		Price 1 piece	Dimensions mm	Pack unit pc.
		Type code	Order code			
Standard customization ¹⁾	Go to configurator	TR/U.1.1-CG	2CKA006300A1547		86x86	1
Premium customization ¹⁾	Go to configurator	TR/U-CG	2CKA006300A1647		86x86	1

¹⁾ The individual design can be selected via the website:

URL: <https://tacteo-configurator.eu.mybuildings.abb.com/>

ABB i-bus® KNX

User Operation – Design Ranges – ABB tacteo®



TBW/U.1.1-CG

Busch-Watchdog® 180 Sensor Standard with Bus Coupler, FM

Ordering possible only in connection with the design ID. Movement detector with up to 4 channels. The bus can be connected via enclosed terminal block. With integrated temperature sensor. With integrated KNX bus coupler.

Description	Standard Design ID	Order details		Price 1 piece	Dimensions mm	Pack unit
		Type code	Order code			
Standard customization ¹⁾	Go to configurator	TBW/U.1.1-CG	2CKA006300A1548		86x86	1
Premium customization ¹⁾	Go to configurator	TBW/U-CG	2CKA006300A1654		86x86	1



TA/U3.1.1-CG

Room Outdoor Sensor with Bus Coupler, FM

Ordering possible only in connection with the design ID. The icons and/or texts are configured by means of a web configuration tool. Freely programmable function "Do not disturb", "Bell" and "Make up room". Push switch function: switching / dimming / blind / sending values / scenes etc. Support of KNX functions through innovative colour concept (yellow=lighting, blue=blind, orange=RTC, magenta=scene and white=neutral/no function assigned) or standard illumination red/green. With integrated KNX bus coupler. With integrated temperature sensor and proximity function. The bus connection is provided via the enclosed bus terminal.

Description	Standard Design ID	Order details		Price 1 piece	Dimensions mm	Pack unit
		Type code	Order code			
Standard customization ¹⁾	Go to configurator	TA/U3.1.1-CG	2CKA006300A1549		86x86	1
Premium customization ¹⁾	Go to configurator	TA/U3-CG	2CKA006300A1646		86x86	1

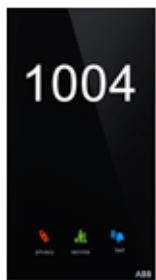

TSN/U.2.1-CG

Room Outdoor Sensor with Room Number and Bus Coupler, FM

Ordering possible only in connection with the design ID. The icons and/or texts are configured by means of a web configuration tool. Freely programmable function "Do not disturb", "Bell" and "Make up room". With backlit room number. Push switch function: switching / dimming / blind / sending values / scenes etc. Support of KNX functions through innovative colour concept (yellow=lighting, blue=blind, orange=RTC, magenta=scene and white=neutral/no function assigned) or standard illumination red/green. The bus connection is provided via the enclosed bus terminal. The device requires a 12...24 V AC/DC external power supply to ensure its operation even with bus voltage failure.

Description	Standard Design ID	Order details		Price 1 piece	Dimensions mm	Pack unit
		Type code	Order code			
Standard customization ¹⁾	Go to configurator	TSN/U.2.1-CG	2CKA006300A1603		86x157	1
Premium customization ¹⁾²⁾	Go to configurator	TSN/U-CG	2CKA006300A1653		86x157	1

¹⁾ The individual design can be selected via the website:

URL: <https://tacteo-configurator.eu.mybuildings.abb.com/>

Touch Control Element with Bus Coupler, FM

Freely configurable multifunction control element. The icons and/or texts are configured by means of a web configuration tool. With integrated KNX bus coupler. With integrated temperature sensor and proximity function. Push switch function: switching / dimming / blind / sending values / scenes etc. Support of KNX functions through innovative colour concept (yellow=lighting, blue=blind, orange=RTC, magenta=scene and white=neutral/no function assigned) or standard illumination red/green. The bus connection is provided via the enclosed bus terminal.



TB/U1.3.1-CG

1-fold

Description	Standard Design ID	Order details		Price 1 piece	Dimensions	Pack unit
		Type code	Order code			
Standard customization ¹⁾	Go to configurator	TB/U1.3.1-CG	2CKA006300A1590	€	mm	pc.
Premium customization ^{1) 2)}	Go to configurator	TB/U1-CG	2CKA006300A1641		115x86	1



TB/U2.8.1-CG

2-fold

Description	Standard Design ID	Order details		Price 1 piece	Dimensions	Pack unit
		Type code	Order code			
Standard customization ¹⁾	Go to configurator	TB/U2.8.1-CG	2CKA006300A1579	€	mm	pc.
Premium customization ^{1) 2)}	Go to configurator	TB/U2-CG	2CKA006300A1642		115x86	1



TB/U4.8.1-CG

4-fold

Description	Standard Design ID	Order details		Price 1 piece	Dimensions	Pack unit
		Type code	Order code			
Standard customization ¹⁾	Go to configurator	TB/U4.8.1-CG	2CKA006300A1593	€	mm	pc.
Premium customization ^{1) 2)}	Go to configurator	TB/U4-CG	2CKA006300A1643		115x86	1



TB/U6.8.1-CG

6-fold

Description	Standard Design ID	Order details		Price 1 piece	Dimensions	Pack unit
		Type code	Order code			
Standard customization ¹⁾	Go to configurator	TB/U6.8.1-CG	2CKA006300A1594	€	mm	pc.
Premium customization ^{1) 2)}	Go to configurator	TB/U6-CG	2CKA006300A1644		115x86	1

¹⁾ The individual design can be selected via the website:

URL: <https://tacteo-configurator.eu.mybuildings.abb.com/>

ABB i-bus® KNX

User Operation – Design Ranges – ABB tacteo®



TR/U.3.1-CG

Touch Room Temperature Controller with Bus Coupler, FM

Ordering possible only in connection with the design ID. The icons and/or texts are configured by means of a web configuration tool. Support of KNX functions through innovative colour concept (yellow=lighting, blue=blind, orange=RTC, magenta=scene and white=neutral/no function assigned) or standard illumination red/green. Control element with room thermostat function for controlling TSA/K 230.1, TSA/K 24.1 in connection with KNX-Heating actuator, commercially available valve drives or analogue valve drives (continuous controllers). The controller is a constant room temperature controller for ventilator convectors (fan coils) in 2-pipe and 4-pipe systems and conventional heating or cooling systems. The fan stage can be switched manually or in automatic mode. Class of temperature controller 1. Contribution to space heating energy efficiency 1,0 %. With integrated KNX bus coupler.

Description	Standard Design ID	Order details		Price 1 piece	Dimensions mm	Pack unit
		Type code	Order code			
Standard customization ¹⁾	Go to configurator	TR/U.3.1-CG	2CKA006300A1595		115x86	1
Premium customization ^{1) 2)}	Go to configurator	TR/U-CG	2CKA006300A1647	€	115x86	1



TBW/U.3.1-CG

Busch-Watchdog® 180 Sensor Standard with Bus Coupler, FM

Ordering possible only in connection with the design ID. Movement detector with up to 4 channels. The bus can be connected via enclosed terminal block. With integrated temperature sensor. With integrated KNX bus coupler.

Description	Standard Design ID	Order details		Price 1 piece	Dimensions mm	Pack unit
		Type code	Order code			
Standard customization ¹⁾	Go to configurator	TBW/U.3.1-CG	2CKA006300A1596		115x86	1
Premium customization ^{1) 2)}	Go to configurator	TBW/U-CG	2CKA006300A1654	€	115x86	1



TA/U3.3.1-CG

Room Outdoor Sensor with Bus Coupler, FM

Ordering possible only in connection with the design ID. The icons and/or texts are configured by means of a web configuration tool. Freely programmable function "Do not disturb", "Bell" and "Make up room". Push switch function: switching / dimming / blind / sending values / scenes etc. Support of KNX functions through innovative colour concept (yellow=lighting, blue=blind, orange=RTC, magenta=scene and white=neutral/no function assigned) or standard illumination red/green. With integrated KNX bus coupler. With integrated temperature sensor and proximity function. The bus connection is provided via the enclosed bus terminal.

Description	Standard Design ID	Order details		Price 1 piece	Dimensions mm	Pack unit
		Type code	Order code			
Standard customization ¹⁾	Go to configurator	TA/U3.3.1-CG	2CKA006300A1597		115x86	1
Premium customization ^{1) 2)}	Go to configurator	TA/U3-CG	2CKA006300A1646	€	115x86	1

¹⁾ The individual design can be selected via the website:

URL: <https://tacteo-configurator.eu.mybuildings.abb.com/>

Touch Control Element with Bus Coupler, FM

Freely configurable multifunction control element. The icons and/or texts are configured by means of a web configuration tool. With integrated KNX bus coupler. With integrated temperature sensor and proximity function. Push switch function: switching / dimming / blind / sending values / scenes etc. Support of KNX functions through innovative colour concept (yellow=lighting, blue=blind, orange=RTC, magenta=scene and white=neutral/no function assigned) or standard illumination red/green. The bus connection is provided via the enclosed bus terminal.



TB/U1.2.1-CG

1-fold

Description	Standard Design ID	Order details		Price 1 piece	Dimensions	Pack unit
		Type code	Order code			
Standard customization ¹⁾	Go to configurator	TB/U1.2.1-CG	2CKA006300A1578	€	86x115 mm	1 pc.
Premium customization ^{1) 2)}	Go to configurator	TB/U1-CG	2CKA006300A1641	€	86x115 mm	1 pc.



TB/U2.7.1-CG

2-fold

Description	Standard Design ID	Order details		Price 1 piece	Dimensions	Pack unit
		Type code	Order code			
Standard customization ¹⁾	Go to configurator	TB/U2.7.1-CG	2CKA006300A1580	€	86x115 mm	1 pc.
Premium customization ^{1) 2)}	Go to configurator	TB/U2-CG	2CKA006300A1642	€	86x115 mm	1 pc.



TB/U4.7.1-CG

4-fold

Description	Standard Design ID	Order details		Price 1 piece	Dimensions	Pack unit
		Type code	Order code			
Standard customization ¹⁾	Go to configurator	TB/U4.7.1-CG	2CKA006300A1581	€	86x115 mm	1 pc.
Premium customization ^{1) 2)}	Go to configurator	TB/U4-CG	2CKA006300A1643	€	86x115 mm	1 pc.



TB/U6.7.1-CG

6-fold

Description	Standard Design ID	Order details		Price 1 piece	Dimensions	Pack unit
		Type code	Order code			
Standard customization ¹⁾	Go to configurator	TB/U6.7.1-CG	2CKA006300A1582	€	86x115 mm	1 pc.
Premium customization ^{1) 2)}	Go to configurator	TB/U6-CG	2CKA006300A1644	€	86x115 mm	1 pc.

¹⁾ The individual design can be selected via the website:

URL: <https://tacteo-configurator.eu.mybuildings.abb.com/>

ABB i-bus® KNX

User Operation – Design Ranges – ABB tacteo®



TR/U.2.1-CG

Touch Room Temperature Controller with Bus Coupler, FM

Ordering possible only in connection with the design ID. The icons and/or texts are configured by means of a web configuration tool. Support of KNX functions through innovative colour concept (yellow=lighting, blue=blind, orange=RTC, magenta=scene and white=neutral/no function assigned) or standard illumination red/green. Control element with room thermostat function for controlling TSA/K 230.1, TSA/K 24.1 in connection with KNX-Heating actuator, commercially available valve drives or analogue valve drives (continuous controllers). The controller is a constant room temperature controller for ventilator convectors (fan coils) in 2-pipe and 4-pipe systems and conventional heating or cooling systems. The fan stage can be switched manually or in automatic mode. Class of temperature controller 1. Contribution to space heating energy efficiency 1,0 %. With integrated KNX bus coupler.

Description	Standard Design ID	Order details		Price 1 piece	Dimensions mm	Pack unit
		Type code	Order code			
Standard customization ¹⁾	Go to configurator	TR/U.2.1-CG	2CKA006300A1583		86x115	1
Premium customization ^{1) 2)}	Go to configurator	TR/U-CG	2CKA006300A1647		86x115	1



TBW/U.2.1-CG

Busch-Watchdog® 180 Sensor Standard with Bus Coupler, FM

Ordering possible only in connection with the design ID. Movement detector with up to 4 channels. The bus can be connected via enclosed terminal block. With integrated temperature sensor. With integrated KNX bus coupler.

Description	Standard Design ID	Order details		Price 1 piece	Dimensions mm	Pack unit
		Type code	Order code			
Standard customization ¹⁾	Go to configurator	TBW/U.2.1-CG	2CKA006300A1584		86x115	1
Premium customization ^{1) 2)}	Go to configurator	TBW/U-CG	2CKA006300A1654		86x115	1

¹⁾ The individual design can be selected via the website:

URL: <https://tacteo-configurator.eu.mybuildings.abb.com/>



TA/U3.2.1-CG

Room Outdoor Sensor with Bus Coupler, FM

Ordering possible only in connection with the design ID. The icons and/or texts are configured by means of a web configuration tool. Freely programmable function "Do not disturb", "Bell" and "Make up room". Push switch function: switching / dimming / blind / sending values / scenes etc. Support of KNX functions through innovative colour concept (yellow=lighting, blue=blind, orange=RTC, magenta=scene and white=neutral/no function assigned) or standard illumination red/green. With integrated KNX bus coupler. With integrated temperature sensor and proximity function. The bus connection is provided via the enclosed bus terminal. The device is mounted exclusively via the Italian flush-mounted device box according to EN60670 (CEI 23-48).

Description	Standard Design ID	Order details		Price 1 piece	Dimensions mm	Pack unit
		Type code	Order code			
Standard customization ¹⁾	Go to configurator	TA/U3.2.1-CG	2CKA006300A1585		86x115	1
Premium customization ¹⁾²⁾	Go to configurator	TA/U3-CG	2CKA006300A1646		86x115	1

¹⁾ The individual design can be selected via the website:

URL: <https://tacteo-configurator.eu.mybuildings.abb.com/>

ABB i-bus® KNX

User Operation – Design Ranges – ABB tacteo®



TZW/U.0.1.CK

Removal protection tool

Tools for the removal of a device with installed removal protection TZE/U.0.11.CK. Installation is carried out on the flush-mounted insert of the device.

Description	Mod. width	Order details		Price	Weight	Pack
		Type code	Order code	1 piece	1 piece	unit
			€	kg	pc.	
	–	TZW/U.0.1.CK	2CKA006300A1611			



TZE/U.0.1.CK

Removal protection for control elements

Prevents the disassembly of ABB Tenton® and Busch tacteo® control elements, room temperature controllers, external room sensors and movement detectors.

The tool with the mounted removal protection is disassembled using mounting tool TZW/U.x.x-CK.

Description	Mod. width	Order details		Price	Weight	Pack
		Type code	Order code	1 piece	1 piece	unit
			€	kg	pc.	
	–	TZE/U.0.1.CK	2CKA006300A1633			



TZE/U.0.2.CK

Removal protection for access control devices for squared, horizontal and room number glass versions

Prevents the disassembly of ABB tacteo® card holders, card readers and external room sensors with/without card readers and room numbers.

Description	Mod. width	Order details		Price	Weight	Pack
		Type code	Order code	1 piece	1 piece	unit
			€	kg	pc.	
	–	TZE/U.0.2.CK	2CSY245271S3601			



TZE/U.0.3.CK

Removal protection for access control devices for vertical glass versions

Prevents the dismantling of ABB tacteo® card holders, card readers and external room sensors with/without card readers and room numbers.

Description	Mod. width	Order details		Price	Weight	Pack
		Type code	Order code	1 piece	1 piece	unit
			€	kg	pc.	
	–	TZE/U.0.3.CK	2CSY233741S3611			

ABB i-bus® KNX

User Operation – Design Ranges – Busch-priOn®

Busch-priOn® allows you to control and monitor functions for the entire room. Light, scenes, timer, blind control unit, heating control unit – all functions are controlled simply and intuitively via a rotary dial, and freely programmable functions can be called up via the rocker switches. Busch-priOn® is a non-fixed, modular concept.

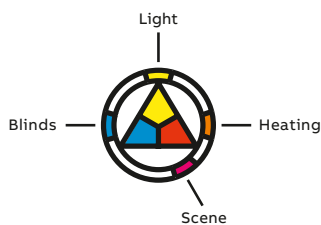

Colours that make life easier.

A consistent colour coding concept and durable LED technology make Busch-priOn® extremely easy to operate. The dial lights up in the colours of the coding system, thus providing feedback on the function currently selected. Yellow stands for lighting, blue for the blind control unit, magenta for light scenes and orange for the heating control unit. These colours are also found on the rocker switches of the control element panels.

01



The rotary control element is equipped with a freely programmable button which can be pressed and turned. It can be used to switch and dim individual lamps, but also to switch on whole groups of lamps with one press of a button and vary their brightness continuously via the dial.

Function

Dimming | Blinds | Value | Light scenes | Logic functions | Time functions

Features

Illuminated dial | Colour coding concept | Anti-theft protection | Day/night operation

02



The single control element is equipped with a freely programmable “large” operating button. It can be assigned to one topic and can carry out a maximum of two commands.

Function

Switching | Dimming | Blinds | Value | Buttons | Light scenes | Logic functions | Time functions

Features

Illuminated rocker switch | Colour coding concept | Freely programmable control button | Anti-theft protection | Replaceable labelling symbol (Fig. shows Lighting labelling symbol)

03



The triple control element is equipped with 3 freely programmable control buttons. Each can be assigned to one topic and can carry out a maximum of two commands.

Function

Switching | Dimming | Blinds | Value | Buttons | Light scenes | Logic functions | Time functions

Features

Illuminated rocker switches | Colour coding concept | Freely programmable control buttons | Anti-theft protection | Replaceable labelling symbol (Fig. shows labelling symbols Lighting, Blinds and Scene)

01 Rotary control element

02 1 gang control element

03 3 gang control element



reddot design award
best of the best 2008

Busch-priOn® received special commendment in the category “best of the best,” winning the “red dot award: communication design 2008” for its interface design.

01



A single-line display with integrated room temperature controller has been designed for the Busch-priOn® 3 gang control element, technically reduced to the basics and optically elegant. It is particularly easy to read due to the monochromatic design for white on black information. The room temperature controller, information function like time and date, up to 17 freely programmable text displays, IR sensor and proximity sensor have been integrated into the display. The design of the display is available in the colour and material “glass black” only.

02



Busch-priOn® is ideal in combination with the carat® switch series, which has surfaces in the same design.

03



The Busch-priOn® flush-mounted movement sensor can be used individually or with other Busch-priOn® modules. Practical because users thus do not have to look for the light switch and are greeted with light when first entering a dark room.

01 3 gang control element with single-line display and temperature controller

02 carat® glass black

03 Flush-mounted movement sensor

ABB i-bus® KNX

User Operation – Design Ranges –
Planning aid for Busch-priOn®

End strips without function

studio white,
Article-No. 6348-24G-101-500

glass black,
Article-No. 6348-825-101-500

white glass,
Article-No. 6348-811-101-500

stainless steel,
Article-No. 6348-860-101-500

Support frame, bus coupler



Note:

This power adaptor can supply up to 15 power bus couplers with current.

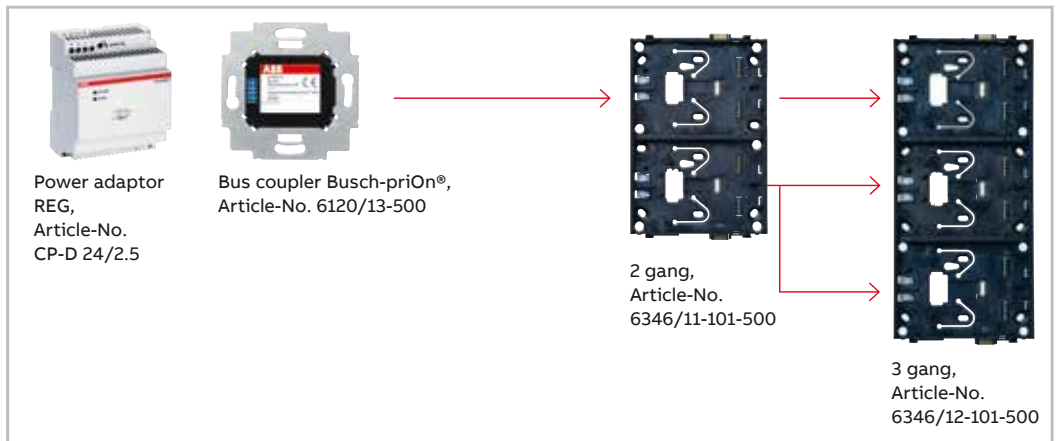

End strip



Commissioning adaptor,
Article-No. 6149/21-500

End strips without function

studio white,
Article-No. 6349-24G-101-500

white glass,
Article-No. 6349-811-101-500

glass black,
Article-No. 6349-825-101-500

stainless steel,
Article-No. 6349-860-101-500

End strip with IR proximity function

glass black,
Article-No.
6350-825-101-500



Note:
only combinable
with 3 gang control
element



Single-line
display and room
thermostat,
Article-No.
6351-825-101-500



Control element,
1 gang,
Article-No.
6340-825-101-500



Control element,
3 gang, Article-No.
6342-825-101-500

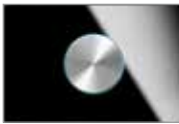

Rotary control
element, 1 gang,
Article-No.
6341-825-101-500



Busch-Watchdog,
180 FM,
Article-No.
6345-825-101-500

Labelling symbols



Labelling inserts for blinds, lighting,
RTC and scene. The colours are repeated in the
Busch-Jaeger colour concept.

End strips with temperature sensor.

Not combinable with FM
actuators.

studio white,
Article-No. 6352-24G-101-500

white glass,
Article-No. 6352-811-101-500

glass black,
Article-No. 6352-825-101-500

stainless steel,
Article-No. 6352-860-101-500

ABB i-bus® KNX

User Operation – Design Ranges – Busch-priOn®



6120/12-101-500

Bus Coupler, FM

for Busch-priOn® support frame 1-fold 6346/10-10x and control elements 6122/0x-xxx, 6124/0x-xxx, 6125/0x-xxx, 6126/0x-xxx, 6127/0x-xxx, 6128/0x-xxx and 6129/0x-xxx.

Description	Mod. width	Order details		Price	Weight	Pack
		Type code	Order code	1 piece	1 piece	unit
				€	kg	pc.
	–	6120/12-101-500	2CKA006120A0075		0.068	1
swiss version	–	6120/12-101-508	2CKA006120A0076		0.068	1



6120/13-500

Power Bus Coupler, FM, Busch-priOn®

For Busch-priOn® base frame 1-fold, 2-fold and 3-fold. Separate power supply required. The KNX connection is used exclusively for bus communication.

Description	Mod. width	Order details		Price	Weight	Pack
		Type code	Order code	1 piece	1 piece	unit
				€	kg	pc.
	–	6120/13-500	2CKA006120A0072		0.095	1
swiss version	–	6120/13-508	2CKA006120A0073		0.095	1



6346/10-101-500

Base Frame, 1-fold, Busch-priOn®

For Busch-priOn® for seating and contact connection of rotary control elements, operating element 1-fold and 3-fold as well as the top/bottom finishing strip. For contacting with the Bus Coupler priOn or Power Bus Coupler priOn.

Description	Mod. width	Order details		Price	Weight	Pack
		Type code	Order code	1 piece	1 piece	unit
				€	kg	pc.
	–	6346/10-101-500	2CKA006310A0135		0.012	1



6346/11-101-500

Base Frame, 2-fold, Busch-priOn®

For Busch-priOn® for seating and contact connection of 8.89 cm (3.5") TFT colour display with rotary control element, rotary control element 1-fold and 3-fold as well as the top/bottom finishing strip. For contacting with the Power Bus Coupler priOn.

Description	Mod. width	Order details		Price	Weight	Pack
		Type code	Order code	1 piece	1 piece	unit
				€	kg	pc.
	–	6346/11-101-500	2CKA006310A0137		0.116	1



6346/12-101-500

Base Frame, 3-fold, Busch-priOn®

For Busch-priOn® for seating and contact connection of 8.89 cm (3.5") TFT colour display with rotary control element, rotary control element 1-fold and 3-fold as well as the top/bottom finishing strip. For contacting with the Power Bus Coupler priOn.

Description	Mod. width	Order details		Price	Weight	Pack unit
		Type code	Order code	1 piece	1 piece	
				€	kg	pc.
	-	6346/12-101-500	2CKA006310A0139		0.159	1



6340-825-101-500

Control Element, 1-fold, Busch-priOn®

Freely programmable multi-function operation element for installation in the Base Frame 1-fold, 2-fold or 3-fold. Supports the KNX functions with innovative colour concept on the labelling symbols or standard lighting in red/green. The accompanying symbol can be substituted by other alternative labelling symbols.

Description	Mod. width	Order details		Price	Weight	Pack unit
		Type code	Order code	1 piece	1 piece	
				€	kg	pc.
studio white, high gloss	-	6340-24G-101-500	2CKA006310A0109		0.188	1
white glass	-	6340-811-101-500	2CKA006310A0168		0.164	1
glas black	-	6340-825-101-500	2CKA006310A0108		0.145	1
stainless steel	-	6340-866-101-500	2CKA006310A0106		0.325	1



6342-825-101-500

Control Element, 3-fold, Busch-priOn®

Freely programmable multi-function operation element for installation in the Base Frame 1-fold, 2-fold or 3-fold. Supports the KNX functions with innovative colour concept on the labelling symbols or standard lighting in red/green. The accompanying symbol can be substituted by other alternative labelling symbols.

Description	Mod. width	Order details		Price	Weight	Pack unit
		Type code	Order code	1 piece	1 piece	
				€	kg	pc.
studio white, high gloss	-	6342-24G-101-500	2CKA006310A0125		0.191	1
white glass	-	6342-811-101-500	2CKA006310A0172		0.203	1
glas black	-	6342-825-101-500	2CKA006310A0124		0.203	1
stainless steel	-	6342-866-101-500	2CKA006310A0122		0.32	1

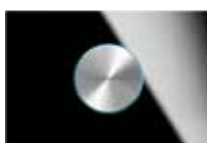

6341-825-101-500

Rotary Control Element, 1-fold, Busch-priOn®

Freely programmable multi-function rotary control element for installation in the Base Frame 1-fold, 2-fold or 3-fold. Supports the KNX functions with innovative colour concept on the rotary knob or standard lighting in red/green. Rotary knob stainless steel.

Description	Mod. width	Order details		Price	Weight	Pack unit
		Type code	Order code	1 piece	1 piece	
				€	kg	pc.
studio white, high gloss	-	6341-24G-101-500	2CKA006310A0117		0.218	1
white glass	-	6341-811-101-500	2CKA006310A0170		0.23	1
glas black	-	6341-825-101-500	2CKA006310A0116		0.175	1
stainless steel	-	6341-866-101-500	2CKA006310A0114		0.336	1

ABB i-bus® KNX

User Operation – Design Ranges – Busch-priOn®



6345-825-101-500

Busch Watchdog® 180 FM Sensor, Busch-priOn®

Sends switching commands with motion detection in combination with the bus coupler Busch-priOn®. Programmable via ETS for automatic and semi-automatic operation.

Description	Mod. width	Order details		Price	Weight	Pack
		Type code	Order code	1 piece	1 piece	unit
			€	kg	pc.	
studio white, high gloss	–	6345-24G-101-500	2CKA006310A0081		0.188	1
white glass	–	6345-811-101-500	2CKA006310A0176		0.166	1
glas black	–	6345-825-101-500	2CKA006310A0080		0.167	1
stainless steel	–	6345-866-101-500	2CKA006310A0078		0.325	1

6348-825-101-500

Top End Strip, Busch-priOn®

For mounting on Base Frame 1-fold to 3-fold.

Description	Mod. width	Order details		Price	Weight	Pack
		Type code	Order code	1 piece	1 piece	unit
			€	kg	pc.	
studio white, high gloss	–	6348-24G-101-500	2CKA006310A0147		0.024	1
white glass	–	6348-811-101-500	2CKA006310A0178		0.034	1
glas black	–	6348-825-101-500	2CKA006310A0146		0.027	1
stainless steel	–	6348-860-101-500	2CKA006310A0144		0.048	1

6350-825-101-500

Top End Strip with IR Receiver and Proximity Sensor, Busch-priOn®

For mounting on Base Frame 1-fold to 3-fold. With integrated IR receiver for control by IR handheld control as well as integrated proximity function.

Description	Mod. width	Order details		Price	Weight	Pack
		Type code	Order code	1 piece	1 piece	unit
			€	kg	pc.	
glas black	–	6350-825-101-500	2CKA006310A0157		0.037	1



6349-825-101-500
Bottom End Strip, without logo, Busch-priOn®

For mounting on Base Frame 1-fold to 3-fold.

Description	Mod. width	Order details		Price	Weight	Pack
		Type code	Order code	1 piece	1 piece	unit
			€	kg	pc.	
studio white, high gloss	-	6349-24G-101-500	2CKA006310A0155		0.024	1
white glass	-	6349-811-101-500	2CKA006310A0180		0.035	1
glas black	-	6349-825-101-500	2CKA006310A0154		0.027	1
stainless steel	-	6349-860-101-500	2CKA006310A0152		0.048	1



6352-825-101-500
Bottom End Strip with Temperature Sensor, Busch-priOn®

For mounting on Base Frame 1-fold to 3-fold. Provides the value measured by the temperature sensor to the 8.89 cm (3.5") TFT colour display or the room thermostat.

Description	Mod. width	Order details		Price	Weight	Pack
		Type code	Order code	1 piece	1 piece	unit
			€	kg	pc.	
studio white, high gloss	-	6352-24G-101-500	2CKA006310A0165		0.024	1
white glass	-	6352-811-101-500	2CKA006310A0182		0.04	1
glas black	-	6352-825-101-500	2CKA006310A0164		0.024	1
stainless steel	-	6352-860-101-500	2CKA006310A0162		0.048	1



6351/08-825-500
Top End Strip with Display, Room Thermostat, IR Receiver and Proximity Sensor, Busch-priOn®

Top end strip for installation on 1 gang to 3 gang support frame (6346/10-101, 6346/11-101 and 6346/12-101). With integrated IR receiver for control using the Busch remote control 6010-25 or 6020-.../6121... and integrated proximity function. For heating and cooling (PI, PWM or 2-point). For control of up to 5-level ventilation actuators. With manual adjustment of fan levels. Master/slave configuration. With base-load operation. Display of up to 17 functions as text and/or icon. Only in connection with 1-gang rotary control element (6341-xxx-101) and 3-gang control element (6342-xxx-101) possible. Incl. 10 logic channels (light scene actuator, sequence actuator, logic gates, etc.). Detection range: frontal: 0.5 m, lateral: 0.5 m. Detection angle: 100 °. Mounting height: 1.1 m. Protection class (Device): IP 20. Temperature range (Device): -5 °C to 45 °C. Dimensions: (L x W x D): 33.4 mm x 106.6 mm x 15.5 mm

Description	Mod. width	Order details		Price	Weight	Pack
		Type code	Order code	1 piece	1 piece	unit
			€	kg	pc.	
glas black	-	6351/08-825-500	2CKA006310A0183		0.064	1

ABB i-bus® KNX

User Operation – Design Ranges – Busch-priOn®



6353/20-860-500

Inscription Symbols, Busch-priOn®

For Busch-priOn® operating element 1-fold to 3-fold with different symbols.

Description	Mod. width	Order details		Price	Weight	Pack
		Type code	Order code	1 piece	1 piece	unit
				€	kg	pc.
lighting	–	6353/20-860-500	2CKA006310A0093		0.011	1
blind	–	6353/30-860-500	2CKA006310A0094		0.011	1
Room Temperature	–	6353/40-860-500	2CKA006310A0095		0.011	1
scene	–	6353/50-860-500	2CKA006310A0096		0.011	1



6149/21-500

Commissioning Interface / Adapter

6120/12-101-500 and 6120/13-500 via USB port or via SD card slot.

With integrated battery for independent operation for up to 8 h.

Description	Mod. width	Order details		Price	Weight	Pack
		Type code	Order code	1 piece	1 piece	unit
				€	kg	pc.
	–	6149/21-500	2CKA006133A0201		0.15	1



CP-D 24/2.5

Power Supply Unit, 24 V DC, 2.5 A

6120/12-101-500 and 6120/13-500 via USB port or via SD card slot.

With integrated battery for independent operation for up to 8 h.

Description	Mod. width	Order details		Price	Weight	Pack
		Type code	Order code	1 piece	1 piece	unit
				€	kg	pc.
	–	CP-D 24/2.5	2CDG120037R0011		0.252	1

HVAC room automation

Solutions for HVAC room automation

ABB's room automation solutions ensure that all functions in a room are operated as efficiently as possible to save operational costs and improve the space environment.

For perfect climate conditions in a room

ABB's portfolio includes controllers for fan coils, radiators, floor heating and cooling ceiling applications, and devices for operating that can be easily installed on the wall or above the ceiling. Room control units are determined for small to medium commercial buildings. The whole ABB i-bus® KNX product portfolio is compatible with ClimaECO.



Easy installation and commissioning

Room Control Unit, SAR/A

The room temperature control unit allows every kind of room to be individually and conveniently heated or cooled as needed.

- Can be connected directly to FCC/S and VC/S
- Easy installation and commissioning
- Optimal price/performance
- No power supply needed

User operation products



High degree of functionality

ClimaECO Room Controller

ABB has optimized its range of KNX room control units for commercial buildings. The result: easy-to-use room thermostats.

- Available with integrated room temperature controller and CO₂/humidity sensor
- Can be flush or surface-mounted
- Control of all room functions from HVAC to shading and lighting

ABB i-bus® KNX

User Operation – Design Ranges – ABB Tenton®



SBS/U6.0.1-84

Control Element with RTC Slave Unit, 6-fold

Freely configurable multifunction control element. Room Thermostat slave with max. 6 gang control. With labelling field. Transparent labelling sheet with standard symbols included in delivery. Support of KNX functions through innovative colour concept (yellow=lighting, blue=blind, orange=RTC, magenta=scene and white=neutral/no function assigned) or standard illumination red/green. Rocker switch left/right (switching/dimming/blind/value sender/light scenes/fan function). With integrated temperature sensor. With actual value temperature display. With display of set-value temperature. The bus can be connected via enclosed terminal block.

Description	Mod. width	Order details		Price	Weight	Pack unit
		Type code	Order code	1 piece	1 piece	
				€	kg	pc.
davos/studio white	–	SBS/U6.0.1-84	2CKA006330A0002			1
studio white matt	–	SBS/U6.0.1-884	2CKA006330A0036			1
black matt	–	SBS/U6.0.1-885	2CKA006330A0037			1
aluminium silver	–	SBS/U6.0.1-83	2CKA006330A0038			1



SBR/U6.0.1-84

Room Temperature Controller with Control Element, 6-fold

Freely configurable multifunction control element. With integrated KNX bus coupler. With labelling field. Support of KNX functions through innovative colour concept (yellow=lighting, blue=blind, orange=RTC, magenta=scene and white=neutral/no function assigned) or standard illumination red/green. Push switch function: switching / dimming / blind / sending values / scenes etc. For activating heating, ventilation and fan coil actuators. Master/slave configuration. With base-load operation. The fan stage can be switched manually or in automatic mode. Class of temperature controller 1.

Description	Mod. width	Order details		Price	Weight	Pack unit
		Type code	Order code	1 piece	1 piece	
				€	kg	pc.
davos/studio white	–	SBR/U6.0.1-84	2CKA006330A0004			1
studio white matt	–	SBR/U6.0.1-884	2CKA006330A0042			1
black matt	–	SBR/U6.0.1-885	2CKA006330A0043			1
aluminium silver	–	SBR/U6.0.1-83	2CKA006330A0044			1



SBS/U10.0.1-84

Control Element with RTC Slave Unit, 10-fold

Freely configurable multifunction control element. With labelling field. Transparent labelling sheet with standard symbols included in delivery. Support of KNX functions through innovative colour concept (yellow=lighting, blue=blind, orange=RTC, magenta=scene and white=neutral/no function assigned) or standard illumination red/green. Rocker switch left/right (switching/dimming/blind/value sender/light scenes/fan function). With integrated temperature sensor. With actual value temperature display. With display of set-value temperature. The bus can be connected via enclosed terminal block.

Description	Mod. width	Order details		Price	Weight	Pack unit
		Type code	Order code	1 piece	1 piece	
				€	kg	pc.
davos/studio white	–	SBS/U10.0.1-84	2CKA006330A0006			1
studio white matt	–	SBS/U10.0.1-884	2CKA006330A0048			1
black matt	–	SBS/U10.0.1-885	2CKA006330A0049			1
aluminium silver	–	SBS/U10.0.1-83	2CKA006330A0050			1



SBR/U10.0.1-84

Room Temperature Controller with Control Element, 10-fold

Freely configurable multifunction control element. With integrated KNX bus coupler. With labelling field. Support of KNX functions through innovative colour concept (yellow=lighting, blue=blind, orange=RTC, magenta=scene and white=neutral/no function assigned) or standard illumination red/green. Push switch function: switching / dimming / blind / sending values / scenes etc. Master/slave configuration. With base-load operation. The controller is a constant room temperature controller for ventilator convectors (fan coils) in 2-pipe and 4-pipe systems and conventional heating or cooling systems. The fan stage can be switched manually or in automatic mode. Class of temperature controller 1.

Description	Mod. width	Order details		Price	Weight	Pack unit
		Type code	Order code	1 piece	1 piece	
				€	kg	pc.
davos/studio white	-	SBR/U10.0.1-84	2CKA006330A0008			1
studio white matt	-	SBR/U10.0.1-884	2CKA006330A0054			1
black matt	-	SBR/U10.0.1-885	2CKA006330A0055			1
aluminium silver	-	SBR/U10.0.1-83	2CKA006330A0056			1



SBC/U6.0.1-84

RTC with CO₂/Humidity Sensor and Control Element

Control element with room temperature controller function and CO₂/moisture/air pressure sensor. With integrated KNX bus coupler. With labelling field. Support of KNX functions through innovative colour concept (yellow=lighting, blue=blind, orange=RTC, magenta=scene and white=neutral/no function assigned) or standard illumination red/green. Push switch function: switching / dimming / blind / sending values / scenes etc. For activating heating, ventilation and fan coil actuators. Master/slave configuration. With base-load operation. The fan stage can be switched manually or in automatic mode. Class of temperature controller 1.

Description	Mod. width	Order details		Price	Weight	Pack unit
		Type code	Order code	1 piece	1 piece	
				€	kg	pc.
davos/studio white, 6-fold	-	SBC/U6.0.1-84	2CKA006330A0010			1
studio white matt, 6-fold	-	SBC/U6.0.1-884	2CKA006330A0060			1
black matt, 6-fold	-	SBC/U6.0.1-885	2CKA006330A0061			1
aluminium silver, 6-fold	-	SBC/U6.0.1-83	2CKA006330A0062			1
davos/studio white, 10-fold	-	SBC/U10.0.1-84	2CKA006330A0012			1
studio white matt, 10-fold	-	SBC/U10.0.1-884	2CKA006330A0066			1
black matt, 10-fold	-	SBC/U10.0.1-885	2CKA006330A0067			1
aluminium silver, 10-fold	-	SBC/U10.0.1-83	2CKA006330A0068			1

ABB i-bus® KNX

User Operation – Design Ranges – ABB Tenton®



SB/U8.0.1-84

Control Element

With integrated KNX bus coupler. With labelling field. Support of KNX functions through innovative colour concept (yellow=lighting, blue=blind, orange=RTC, magenta=scene and white=neutral/no function assigned) or standard illumination red/green.

Push switch function: switching / dimming / blind / sending values / scenes etc. With integrated temperature sensor. Number of bus subscribers: 1

Description	Mod. width	Order details		Price	Weight	Pack unit
		Type code	Order code	1 piece	1 piece	
				€	kg	pc.
davos/studio white, 8-fold	–	SB/U8.0.1-84	2CKA006330A0014			1
studio white matt, 8-fold	–	SB/U8.0.1-884	2CKA006330A0072			1
black matt, 8-fold	–	SB/U8.0.1-885	2CKA006330A0073			1
aluminium silver, 8-fold	–	SB/U8.0.1-83	2CKA006330A0074			1
davos/studio white, 12-fold	–	SB/U12.0.1-84	2CKA006330A0016			1
studio white matt, 12-fold	–	SB/U12.0.1-884	2CKA006330A0078			1
black matt, 12-fold	–	SB/U12.0.1-885	2CKA006330A0079			1
aluminium silver, 12-fold	–	SB/U12.0.1-83	2CKA006330A0080			1



SAS/A.0.1-84

Support Frame, small, SM

Surface-mounted housing for mounting 8 gang control element, RT with 6 gang control element.

Description	Mod. width	Order details		Price	Weight	Pack unit
		Type code	Order code	1 piece	1 piece	
				€	kg	pc.
davos/studio white	–	SAS/A.0.1-84	2CKA006330A0018			1
studio white matt	–	SAS/A.0.1-884	2CKA006330A0084			1
black matt	–	SAS/A.0.1-885	2CKA006330A0085			1
aluminium silver	–	SAS/A.0.1-83	2CKA006330A0086			1



SAB/A.0.1-84

Support Frame, large, SM

Surface-mounted housing for mounting 12 gang control element, RT with 10 gang control element.

Description	Mod. width	Order details		Price	Weight	Pack unit
		Type code	Order code	1 piece	1 piece	
				€	kg	pc.
davos/studio white	–	SAB/A.0.1-84	2CKA006330A0020			1
studio white matt	–	SAB/A.0.1-884	2CKA006330A0090			1
black matt	–	SAB/A.0.1-885	2CKA006330A0091			1
aluminium silver	–	SAB/A.0.1-83	2CKA006330A0092			1



SLS/A.0.1-84

Cover for Label Area, small, RTC

Marking coverplate for RTR with 6 gang control element.

Description	Mod. width	Order details		Price	Weight	Pack
		Type code	Order code	1 piece	1 piece	unit
				€	kg	pc.
davos/studio white	–	SLS/A.0.1-84	2CKA006330A0022			1
studio white matt	–	SLS/A.0.1-884	2CKA006330A0097			1
black matt	–	SLS/A.0.1-885	2CKA006330A0098			1
aluminium silver	–	SLS/A.0.1-83	2CKA006330A0099			1



SLM/A.0.1-84

Cover for Label Area, Control Element, small

Marking coverplate for 8 gang control element.

Description	Mod. width	Order details		Price	Weight	Pack
		Type code	Order code	1 piece	1 piece	unit
				€	kg	pc.
davos/studio white	–	SLM/A.0.1-84	2CKA006330A0024			1
studio white matt	–	SLM/A.0.1-884	2CKA006330A0105			1
black matt	–	SLM/A.0.1-885	2CKA006330A0106			1
aluminium silver	–	SLM/A.0.1-83	2CKA006330A0107			1



SLB/A.0.1-84

Cover for Label Area, large, RTC

Upper marking coverplate for RT with 10-fold control element.

Description	Mod. width	Order details		Price	Weight	Pack
		Type code	Order code	1 piece	1 piece	unit
				€	kg	pc.
davos/studio white	–	SLB/A.0.1-84	2CKA006330A0026			1
studio white matt	–	SLB/A.0.1-884	2CKA006330A0113			1
black matt	–	SLB/A.0.1-885	2CKA006330A0114			1
aluminium silver	–	SLB/A.0.1-83	2CKA006330A0115			1

ABB i-bus® KNX

User Operation – Design Ranges – ABB Tenton®



SLX/A.0.1-84

Cover for Label Area, Control Element, large

Marking coverplate for 12 gang control element.

Description	Mod. width	Order details		Price	Weight	Pack
		Type code	Order code	1 piece	1 piece	unit
				€	kg	pc.
davos/studio white	–	SLX/A.0.1-84	2CKA006330A0028			1
studio white matt	–	SLX/A.0.1-884	2CKA006330A0121			1
black matt	–	SLX/A.0.1-885	2CKA006330A0122			1
aluminium silver	–	SLX/A.0.1-83	2CKA006330A0123			1

Bottom end strips without manufacturer logo

Bottom end strip for mounting on SBC/U, SBR/U, SBS/U and SB/U.

Description	Mod. width	Order details		Price	Weight	Pack
		Type code	Order code	1 piece	1 piece	unit
				€	kg	pc.
davos/studio white	–	SLY/A.0.1-84	2CKA006330A0030			1
studio white matt	–	SLY/A.0.1-884	2CKA006330A0129			1
black matt	–	SLY/A.0.1-885	2CKA006330A0130			1
aluminium silver	–	SLY/A.0.1-83	2CKA006330A0131			1

SLY/A.0.1-84



ABB i-bus® KNX

User Operation – Design Ranges – Standard Control Elements

The standard control elements are available as 1/2 gang, 2/4 gang or 4/8 gang models. Every switch rocker has two LEDs, which display the status of the connected loads. The separate switch rockers are freely programmable and are suitable for switching and dimming, and also for operating blinds and as a light scene extension unit.

They can also be used in commercial applications. Anti-theft protection has also been integrated – an important factor for installations in public areas.

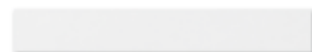
Customised text. Pictograms can be applied to push buttons for easier orientation. A clear text template with standard symbols is included for every sensor. The self-explanatory pictograms are available for the complete range of building control technology and if necessary can be easily replaced. If the appropriate symbol is not included, the push buttons can be labelled as desired. The related bus-coupler unit is included in delivery.

01

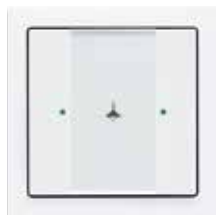

Function

Switching | Dimming | Blinds |
Push-button | Value transmitter |
Light scene extension unit

Features

Labellable switch rockers |
Anti-theft protection | Freely
programmable switches |
Status/orientation light
(red/green/OFF)

02



Function

Switching | Dimming | Blinds |
Push-button | Value transmitter |
Light scene extension unit

Features

Labellable switch rockers |
Anti-theft protection | Freely
programmable switches |
Status/orientation light
(red/green/OFF)

03



Function

Switching | Dimming | Blinds |
Push-button | Value transmitter |
Light scene extension unit

Features

Labellable switch rockers |
Anti-theft protection | Freely
programmable switches |
Status/orientation light
(red/green/OFF)

01 Standard control element 1/2 gang

02 Standard control element 2/4 gang

03 Standard control element 4/8 gang

Standard control element with bus coupler enclosed

With labelling field. Transparent labelling sheet with standard symbols included in delivery.
 Display elements: Two LED per rocker via separate communication object for status (Red/
 Green/OFF) or orientation light. Protection class (Device): IP 20. Temperature range (Device):
 -5 °C to +45 °C. Dimensions: (L x W x D): 63 mm x 63 mm.



6125/01



6126/01



6127/01

Pack unit pc.	Weight 1 pc. kg	Description	Control Element with Bus Coupler, standard, FM, 1-fold with bus coupler enclosed			Control Element with Bus Coupler, standard, FM, 2-fold with bus coupler enclosed			Control Element with Bus Coupler, standard, FM, 4-fold with bus coupler enclosed		
			With 1 Control element: rocker switch left/right			With 2 Control elements: rocker switch left/right			With 4 Control elements: rocker switch left/right		
			Order details	Price 1 pc.		Order details	Price 1 pc.		Order details	Price 1 pc.	
Type	Order code	€	Type	Order code	€	Type	Order code	€			
		future® linear									
1		anthracite	6125/01-81-500	2CKA006115A0205		6126/01-81-500	2CKA006116A0195		6127/01-81-500	2CKA006117A0221	
1		savanne/ivory	6125/01-82-500	2CKA006115A0206		6126/01-82-500	2CKA006116A0196		6127/01-82-500	2CKA006117A0222	
1		aluminium silver ¹⁾	6125/01-83-500	2CKA006115A0207		6126/01-83-500	2CKA006116A0197		6127/01-83-500	2CKA006117A0223	
1		davos/studio white	6125/01-84-500	2CKA006115A0183		6126/01-84-500	2CKA006116A0174		6127/01-84-500	2CKA006117A0200	
1		studio white, matt ¹⁾	6125/01-884-500	2CKA006115A0214		6126/01-884-500	2CKA006116A0204		6127/01-884-500	2CKA006117A0230	
1		black, matt ¹⁾	6125/01-885-500	2CKA006115A0215		6126/01-885-500	2CKA006116A0205		6127/01-885-500	2CKA006117A0231	
		solo®									
1		savanne/ivory	6125/01-82-500	2CKA006115A0206		6126/01-82-500	2CKA006116A0196		6127/01-82-500	2CKA006117A0222	
1		davos/studio white	6125/01-84-500	2CKA006115A0183		6126/01-84-500	2CKA006116A0174		6127/01-84-500	2CKA006117A0200	
1		meteor/grey metallic ¹⁾	6125/01-803-500	2CKA006115A0212		6126/01-803-500	2CKA006116A0202		6127/01-803-500	2CKA006117A0228	
		carat®									
1		anthracite	6125/01-81-500	2CKA006115A0205		6126/01-81-500	2CKA006116A0195		6127/01-81-500	2CKA006117A0221	
1		savanne/ivory	6125/01-82-500	2CKA006115A0206		6126/01-82-500	2CKA006116A0196		6127/01-82-500	2CKA006117A0222	
1		davos/studio white	6125/01-84-500	2CKA006115A0183		6126/01-84-500	2CKA006116A0174		6127/01-84-500	2CKA006117A0200	
		pure stainless steel ¹⁾									
1		stainless steel	6125/01-866-500	2CKA006115A0211		6126/01-866-500	2CKA006116A0201		6127/01-866-500	2CKA006117A0227	
		Busch-axcent®									
1		davos/studio white	6125/01-84-500	2CKA006115A0183		6126/01-84-500	2CKA006116A0174		6127/01-84-500	2CKA006117A0200	

¹⁾ Surface painted

ABB i-bus® KNX

User Operation – Design Ranges – Multifunction Control Elements

The multifunction control elements with LED colour code concept meet the highest demands for comfort and technology. They each come with two RGB LEDs per rocker switch, which conform

to a consistent colour concept. This makes the function obvious at a glance, and the surfaces can be additionally fitted with pictograms. Each side of a rocker switch can be occupied with its

own function – each for calling up one light scene, for instance. This turns a 4 gang control element into an 8 gang control element.

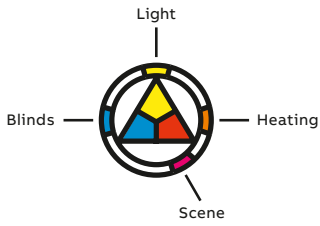

01



02



03



- 01 Multifunction control element 1/2 gang

- 02 Multifunction control element 2/4 gang

- 03 Multifunction control element 4/8 gang

- 04 Multifunction control element 2/4 gang, integrated room thermostat

- 05 Multifunction control element 3/6 gang with IR reception

- 06 FM movement detector standard

- 07 FM movement detector comfort

Function
Switching | Dimming | Blinds | Push-button | Value transmitter | Light scene extension unit | Step-type | Multiple operation | Logic function (including light scenes)

Features
Labellable switch rockers | Anti-theft protection | Freely programmable switches | LED colour code concept

Function
Switching | Dimming | Blinds | Push-button | Value transmitter | Light scene extension unit | Step-type | Multiple operation | Logic function (including light scenes)

Features
Labellable switch rockers | Anti-theft protection | Freely programmable switches | LED colour code concept

Function
Switching | Dimming | Blinds | Push-button | Value transmitter | Light scene extension unit | Step-type | Multiple operation | Logic function (including light scenes)

Features
Labellable switch rockers | Anti-theft protection | Freely programmable switches | LED colour code concept

Wide range. Different shapes, colours and materials fulfil every requirement. KNX control elements are available in the carat®, pure stainless steel, solo®, Busch-axcent® and future® linear pro-

grammes. The complete range of conventional switches from these series is available, so there are no limits to the options for combining KNX components.



04



Function
 Comfort | Stand-by | Night mode | Frost protection | Specified temperature | Time | Date | Heating | Cooling | Fan Coil operation for heating and cooling | Light scenes | Light scene extension unit | Value | Logic function (including light scenes)

Features
 Labellable switch rockers | Anti-theft protection | Display illumination | Colour concept

05



Function
 10 freely programmable IR channels | Switching | Dimming | Blinds | Button | Light scenes | Light scene extension unit | Value | Logic function (including light scenes)

Features
 Labellable switch rockers | Anti-theft protection | Display illumination | Colour concept

06



Function
 4 channels | Logic function (including light scenes)

07



Function
 4 channels | Logic function (including light scenes)

ABB i-bus® KNX

User Operation – Design Ranges – Multifunction Control Elements

Control element, Multi-function/colour concept

For BCU 6120/12-101-500 or 6120/13-500. With labelling field. Support of KNX functions through innovative colour concept or standard illumination red/green. Push switch function: switching/dimming/blind/sending values/scenes etc. Transparent labelling sheet with standard symbols included in delivery. Incl. 10 logic channels (light scene actuator, sequence actuator, logic gates, etc.). Display elements: Two LED per rocker via separate communication object for status (Red/Green/OFF) or orientation light.



6125/02



6126/02



6127/02

Pack unit pc.	Weight 1 pc. kg	Description	Control element, 1/2-fold Multi-function/colour concept		Control element, 2/4-fold Multi-function/colour concept		Control element, 4/8-fold Multi-function/colour concept	
			Order details		Order details		Order details	
			Type	Order code	Type	Order code	Type	Order code
			With 1 Control element: rocker switch left/right		With 2 Control elements: rocker switch left/right		With 4 Control elements: rocker switch left/right	
			Price 1 pc.	Price 1 pc.	Price 1 pc.	Price 1 pc.	Price 1 pc.	Price 1 pc.
			€	€	€	€	€	€
		future® linear						
1		anthracite	6125/02-81-500	2CKA006115A0216	6126/02-81-500	2CKA006116A0206	6127/02-81-500	2CKA006117A0232
1		savanne/ivory	6125/02-82-500	2CKA006115A0217	6126/02-82-500	2CKA006116A0207	6127/02-82-500	2CKA006117A0233
1		aluminium silver ¹⁾	6125/02-83-500	2CKA006115A0218	6126/02-83-500	2CKA006116A0208	6127/02-83-500	2CKA006117A0234
1		davos/studio white	6125/02-84-500	2CKA006115A0219	6126/02-84-500	2CKA006116A0209	6127/02-84-500	2CKA006117A0235
1		studio white, matt ¹⁾	6125/02-884-500	2CKA006115A0226	6126/02-884-500	2CKA006116A0216	6127/02-884-500	2CKA006117A0242
1		black, matt ¹⁾	6125/02-885-500	2CKA006115A0227	6126/02-885-500	2CKA006116A0217	6127/02-885-500	2CKA006117A0243
		solo®						
1		savanne/ivory	6125/02-82-500	2CKA006115A0217	6126/02-82-500	2CKA006116A0207	6127/02-82-500	2CKA006117A0233
1		davos/studio white	6125/02-84-500	2CKA006115A0219	6126/02-84-500	2CKA006116A0209	6127/02-84-500	2CKA006117A0235
1		meteor/grey metallic ¹⁾	6125/02-803-500	2CKA006115A0224	6126/02-803-500	2CKA006116A0214	6127/02-803-500	2CKA006117A0240
		carat®						
1		anthracite	6125/02-81-500	2CKA006115A0216	6126/02-81-500	2CKA006116A0206	6127/02-81-500	2CKA006117A0232
1		savanne/ivory	6125/02-82-500	2CKA006115A0217	6126/02-82-500	2CKA006116A0207	6127/02-82-500	2CKA006117A0233
1		davos/studio white	6125/02-84-500	2CKA006115A0219	6126/02-84-500	2CKA006116A0209	6127/02-84-500	2CKA006117A0235
		pure stainless steel ¹⁾						
1		stainless steel	6125/02-866-500	2CKA006115A0223	6126/02-866-500	2CKA006116A0213	6127/02-866-500	2CKA006117A0239
		Busch-axcent®						
1		davos/studio white	6125/02-84-500	2CKA006115A0219	6126/02-84-500	2CKA006116A0209	6127/02-84-500	2CKA006117A0235
		Dynasty®						
1		anthracite	6125/02-81-500	2CKA006115A0216	6126/02-81-500	2CKA006116A0206	6127/02-81-500	2CKA006117A0232
1		savanne/ivory	6125/02-82-500	2CKA006115A0217	6126/02-82-500	2CKA006116A0207	6127/02-82-500	2CKA006117A0233
1		antique brass	6125/02-840-500	2CKA006115A0452	6126/02-840-500	2CKA006116A0227	6127/02-840-500	2CKA006117A0252

¹⁾ Surface painted



6129/01

Control Element, 3/6-fold, multifunction, with IR-Interface, FM

suitable for KNX bus coupler 6120/12-101-500 and 6120/13-500. With IR interface for Busch-remote controllers 6010-25 or 6020-.../6021-... . Push button function: switching/dimming/blind/value sending/light scenes/step-type switch functions. Switch contacts left/right. Two freely programmable RGB LEDs per rocker. With RGB colour code concept or red/green/OFF-operation. With labeling field. Transparent labeling sheet with standard symbols included in delivery.

Description	Mod. width	Order details		Price	Weight	Pack
		Type code	Order code	1 piece	1 piece	unit
				€	kg	pc.
future® linear						
anthracite	–	6129/01-81-500	2CKA006135A0156		0.08	1
savanne/ivory	–	6129/01-82-500	2CKA006135A0157		0.08	1
aluminium silver ¹⁾	–	6129/01-83-500	2CKA006135A0158		0.08	1
davos/studio white	–	6129/01-84-500	2CKA006135A0146		0.08	1
studio white, matt ¹⁾	–	6129/01-884-500	2CKA006135A0165		0.08	1
black, matt ¹⁾	–	6129/01-885-500	2CKA006135A0166		0.08	1
solo®						
savanne/ivory	–	6129/01-82-500	2CKA006135A0157		0.08	1
davos/studio white	–	6129/01-84-500	2CKA006135A0146		0.08	1
meteor/grey metallic ¹⁾	–	6129/01-803-500	2CKA006135A0163		0.08	1
carat®						
anthracite	–	6129/01-81-500	2CKA006135A0156		0.08	1
savanne/ivory	–	6129/01-82-500	2CKA006135A0157		0.08	1
davos/studio white	–	6129/01-84-500	2CKA006135A0146		0.08	1
pure stainless steel ¹⁾						
stainless steel	–	6129/01-866-500	2CKA006135A0162		0.08	1
Busch-axcent®						
davos/studio white	–	6129/01-84-500	2CKA006135A0146		0.08	1

¹⁾ Surface painted

ABB i-bus® KNX

User Operation – Design Ranges – Movement Detectors



6122/02-84-500

Busch-Watchdog® 180 Comfort, FM

Movement detector with up to 4 channels. For ABB i-bus® KNX 6120/12-101-500, 6120/13-500. Incl. 10 logic channels (light scene actuator, sequence actuator, logic gates, etc.)

Description	Mod. width	Order details		Price	Weight	Pack
		Type code	Order code	1 piece	1 piece	unit
				€	kg	pc.
future® linear						
anthracite	–	6122/02-81-500	2CKA006132A0283		0.063	1
savanne/ivory	–	6122/02-82-500	2CKA006132A0284		0.063	1
aluminium silver ¹⁾	–	6122/02-83-500	2CKA006132A0285		0.063	1
davos/studio white	–	6122/02-84-500	2CKA006132A0263		0.063	1
studio white, matt ¹⁾	–	6122/02-884-500	2CKA006132A0292		0.063	1
black, matt ¹⁾	–	6122/02-885-500	2CKA006132A0293		0.063	1
solo®						
savanne/ivory	–	6122/02-82-500	2CKA006132A0284		0.063	1
davos/studio white	–	6122/02-84-500	2CKA006132A0263		0.063	1
meteor/grey metallic ¹⁾	–	6122/02-803-500	2CKA006132A0290		0.063	1
carat®						
anthracite	–	6122/02-81-500	2CKA006132A0283		0.063	1
savanne/ivory	–	6122/02-82-500	2CKA006132A0284		0.063	1
davos/studio white	–	6122/02-84-500	2CKA006132A0263		0.063	1
pure stainless steel ¹⁾						
stainless steel	–	6122/02-866-500	2CKA006132A0289		0.063	1
Busch-axcent®						
davos/studio white	–	6122/02-84-500	2CKA006132A0263		0.063	1

¹⁾ Surface painted



6122/10-84-500

Busch-Watchdog® 180 Sensor Standard, Select with integrated bus coupler, FM

Movement detector with up to 4 channels. The bus can be connected via enclosed terminal block. With integrated KNX bus coupler.

Description	Mod. width	Order details		Price	Weight	Pack
		Type code	Order code	1 piece	1 piece	unit
				€	kg	pc.
Reflex SI						
white	-	6122/10-212-500	2CKA006132A0373		0.08	1
alpine white	-	6122/10-214-500	2CKA006132A0374		0.08	1
future® linear						
anthracite	-	6122/10-81-500	2CKA006132A0376		0.08	1
ivory	-	6122/10-82-500	2CKA006132A0377		0.08	1
aluminium silver	-	6122/10-83-500	2CKA006132A0378		0.08	1
studio white	-	6122/10-84-500	2CKA006132A0379		0.08	1
studio white matt	-	6122/10-884-500	2CKA006132A0380		0.08	1
black, matt	-	6122/10-885-500	2CKA006132A0381		0.08	1
solo®						
ivory	-	6122/10-82-500	2CKA006132A0377		0.08	1
studio white	-	6122/10-84-500	2CKA006132A0379		0.08	1
grey metallic	-	6122/10-803-500	2CKA006132A0382		0.08	1
Busch-axcent®						
studio white	-	6122/10-84-500	2CKA006132A0379		0.08	1
pure stainless steel						
stainless steel	-	6122/10-866-500	2CKA006132A0385		0.08	1
carat®						
anthracite	-	6122/10-81-500	2CKA006132A0376		0.08	1
ivory	-	6122/10-82-500	2CKA006132A0377		0.08	1
studio white	-	6122/10-84-500	2CKA006132A0379		0.08	1
Dynasty®						
anthracite	-	6122/10-81-500	2CKA006132A0376		0.08	1
ivory	-	6122/10-82-500	2CKA006132A0377		0.08	1
antique brass	-	6122/10-840-500	2CKA006132A0407		0.08	1

ABB i-bus® KNX

User Operation – Design Ranges – Room Thermostats



6128/28-884-500

Room Thermostat with Display and 2/4-fold Switch Sensor, FM

For ABB i-bus® KNX bus coupler 6120/12-101-500, 6120/13-500. Support of KNX functions through innovative colour concept (yellow = lighting, blue = blind, orange = RTC, magenta = scene and white = neutral/no function assigned) or standard illumination red/green. Rocker switch left/right (switching/dimming/blind/value sender/light scenes/fan function). Master/slave configuration. With base-load operation. The controller is a constant room temperature controller for ventilator convectors (fan coils) in 2-pipe and 4-pipe systems and conventional heating or cooling systems. The fan stage can be switched manually or in automatic mode. Transparent labelling sheet with standard symbols included in delivery. Incl. 10 logic channels (light scene actuator, sequence actuator, logic gates, etc.). Control element: Switch contacts left/right, also for selecting setpoint and mode of operation Display elements: LCD showing operation mode and temperature. Protection class (Device): IP 20. Temperature range (Device): -5 °C to 45 °C. Dimensions: (L x W x D): 63 mm x 63 mm.

Description	Mod. width	Order details		Price 1 piece	Weight 1 piece	Pack unit
		Type code	Order code			
future® linear						
anthracite	–	6128/28-81-500	2CKA006134A0331		0.076	1
savanne/ivory	–	6128/28-82-500	2CKA006134A0332		0.076	1
aluminium silver	–	6128/28-83-500	2CKA006134A0333		0.076	1
davos/studio white	–	6128/28-84-500	2CKA006134A0334		0.076	1
studio white, matt	–	6128/28-884-500	2CKA006134A0338		0.076	1
black, matt	–	6128/28-885-500	2CKA006134A0339		0.076	1
solo®						
savanne/ivory	–	6128/28-82-500	2CKA006134A0332		0.076	1
davos/studio white	–	6128/28-84-500	2CKA006134A0334		0.076	1
meteor/grey metallic	–	6128/28-803-500	2CKA006134A0336		0.076	1
carat®						
anthracite	–	6128/28-81-500	2CKA006134A0331		0.076	1
savanne/ivory	–	6128/28-82-500	2CKA006134A0332		0.076	1
davos/studio white	–	6128/28-84-500	2CKA006134A0334		0.076	1
pure stainless steel						
stainless steel	–	6128/28-866-500	2CKA006134A0335		0.076	1
Busch-axcent®						
davos/studio white	–	6128/28-84-500	2CKA006134A0334		0.076	1
Dynasty®						
anthracite	–	6128/28-81-500	2CKA006134A0331		0.076	1
savanne/ivory	–	6128/28-82-500	2CKA006134A0332		0.076	1
antique brass	–	6128/28-840-500	2CKA006134A0342		0.076	1

ABB i-bus® KNX

User Operation – Design Ranges – Frames



1721-184K

Frames, future® linear

For vertical and horizontal installation.

Description	Mod. width	Order details		Price	Weight	Pack
		Type code	Order code	1 piece	1 piece	unit
				€	kg	pc.
1-fold, anthracite	–	1721-181K	2CKA001754A4240		0.024	10
1-fold, savanna/ivory	–	1721-182K-500	2CKA001754A4506		0.024	10
1-fold, aluminium silver ¹⁾	–	1721-183K-500	2CKA001754A4529		0.024	10
1-fold, davos/studio white	–	1721-184K-500	2CKA001754A4498		0.024	10
1-fold, studio white, matt ¹⁾	–	1721-884K-500	2CKA001754A4531		0.024	10
1-fold, black matt ¹⁾	–	1721-885K-500	2CKA001754A4532		0.024	10
2-fold, anthracite	–	1722-181K	2CKA001754A4241		0.041	10
2-fold, savanna/ivory	–	1722-182K	2CKA001754A4231		0.041	10
2-fold, aluminium silver ¹⁾	–	1722-183K-500	2CKA001754A4530		0.04	10
2-fold, davos/studio white	–	1722-184K-500	2CKA001754A4499		0.041	10
2-fold, studio white, matt ¹⁾	–	1722-884K	2CKA001754A4415		0.037	10
2-fold, black matt ¹⁾	–	1722-885K-500	2CKA001754A4534		0.037	10
3-fold, anthracite	–	1723-181K	2CKA001754A4242		0.05	10
3-fold, savanna/ivory	–	1723-182K	2CKA001754A4232		0.05	10
3-fold, aluminium silver ¹⁾	–	1723-183K-500	2CKA001754A4533		0.052	10
3-fold, davos/studio white	–	1723-184K-500	2CKA001754A4502		0.053	10
3-fold, studio white, matt ¹⁾	–	1723-884K	2CKA001754A4416		0.052	10
3-fold, black matt ¹⁾	–	1723-885K	2CKA001754A4421		0.052	10
4-fold, anthracite	–	1724-181K	2CKA001754A4243		0.064	10
4-fold, savanna/ivory	–	1724-182K	2CKA001754A4233		0.064	10
4-fold, aluminium silver ¹⁾	–	1724-183K	2CKA001754A4309		0.064	10
4-fold, davos/studio white	–	1724-184K	2CKA001754A4238		0.064	10
4-fold, studio white, matt ¹⁾	–	1724-884K	2CKA001754A4417		0.064	10
4-fold, black matt ¹⁾	–	1724-885K	2CKA001754A4422		0.064	10
5-fold, anthracite	–	1725-181K	2CKA001754A4244		0.096	1
5-fold, savanna/ivory	–	1725-182K	2CKA001754A4234		0.114	1
5-fold, aluminium silver ¹⁾	–	1725-183K	2CKA001754A4310		0.114	1
5-fold, davos/studio white	–	1725-184K-500	2CKA001754A4517		0.112	1
5-fold, studio white, matt ¹⁾	–	1725-884K	2CKA001754A4418		0.114	1
5-fold, black matt ¹⁾	–	1725-885K	2CKA001754A4423		0.114	1

¹⁾ Surface painted

ABB i-bus® KNX

User Operation – Design Ranges – Frames



1721-80

Frames, solo®

For vertical and horizontal installation.

Description	Mod. width	Order details		Price	Weight	Pack
		Type code	Order code	1 piece	1 piece	unit
				€	kg	pc.
1-fold, chrome, matt	–	1721-80-500	2CKA001754A4535		0.032	10
1-fold, chrome, glossy	–	1721-80G-500	2CKA001754A4538		0.032	10
1-fold, davos/studio white	–	1721-84-500	2CKA001754A4536		0.032	10
2-fold, chrome, matt	–	1722-80-500	2CKA001754A4537		0.055	10
2-fold, chrome, glossy	–	1722-80G	2CKA001754A4327		0.045	10
2-fold, davos/studio white	–	1722-84-500	2CKA001754A4539		0.055	10
3-fold, chrome, matt	–	1723-80-500	2CKA001754A4540		0.066	10
3-fold, chrome, glossy	–	1723-80G	2CKA001754A4328		0.073	10
3-fold, davos/studio white	–	1723-84-500	2CKA001754A4541		0.073	10
4-fold, chrome, matt	–	1724-80	2CKA001754A4107		0.12	1
4-fold, chrome, glossy	–	1724-80G	2CKA001754A4329		0.12	1
4-fold, davos/studio white	–	1724-84	2CKA001754A4112		0.12	1
5-fold, chrome, matt	–	1725-80	2CKA001754A4108		0.14	1
5-fold, chrome, glossy	–	1725-80G	2CKA001754A4330		0.14	1
5-fold, davos/studio white	–	1725-84	2CKA001754A4113		0.14	1



1721-860

Frames, carat®

For vertical and horizontal installation.

Description	Mod. width	Order details		Price	Weight	Pack
		Type code	Order code	1 piece	1 piece	unit
				€	kg	pc.
1-fold, white glass	–	1721-811	2CKA001754A4442		0.161	1
1-fold, bronze	–	1721-821	2CKA001754A4258		0.38	1
1-fold, gold ¹⁾	–	1721-823-101	2CKA001754A4356		0.34	1
1-fold, glass black	–	1721-825	2CKA001754A4322		0.16	1
1-fold, chrome	–	1721-826-101	2CKA001754A4360		0.335	1
1-fold, stainless steel	–	1721-860	2CKA001754A4254		0.34	1
2-fold, white glass	–	1722-811	2CKA001754A4443		0.234	1
2-fold, bronze	–	1722-821	2CKA001754A4259		0.559	1
2-fold, gold ¹⁾	–	1722-823-101	2CKA001754A4357		0.5	1
2-fold, glass black	–	1722-825	2CKA001754A4323		0.24	1
2-fold, chrome	–	1722-826-101	2CKA001754A4361		0.5	1
2-fold, stainless steel	–	1722-860	2CKA001754A4255		0.48	1
3-fold, white glass	–	1723-811	2CKA001754A4444		0.312	1
3-fold, bronze	–	1723-821	2CKA001754A4260		0.678	1
3-fold, gold ¹⁾	–	1723-823-101	2CKA001754A4358		0.66	1
3-fold, glass black	–	1722-825	2CKA001754A4323		0.24	1
3-fold, chrome	–	1723-826-101	2CKA001754A4362		0.66	1
3-fold, stainless steel	–	1723-860	2CKA001754A4256		0.6	1
4-fold, white glass	–	1724-811	2CKA001754A4445		0.388	1
4-fold, bronze	–	1724-821	2CKA001754A4261		0.816	1
4-fold, gold ¹⁾	–	1724-823-101	2CKA001754A4359		0.8	1
4-fold, glass black	–	1724-825	2CKA001754A4325		0.4	1
4-fold, chrome	–	1724-826-101	2CKA001754A4363		0.82	1
4-fold, stainless steel	–	1724-860	2CKA001754A4257		0.758	1

¹⁾ Gold plated 24 carat



1721-866K

Frames, pure stainless steel

For vertical and horizontal installation. Stainless steel material.

Anti-fingerprint (does not leave any visible fingerprints on the material).

Description	Mod. width	Order details		Price	Weight	Pack
		Type code	Order code	1 piece	1 piece	unit
				€	kg	pc.
1-fold, stainless steel	–	1721-866K-500	2CKA001754A4500		0.038	10
2-fold, stainless steel	–	1722-866K-500	2CKA001754A4501		0.064	10
3-fold, stainless steel	–	1723-866K	2CKA001754A4319		0.083	10
4-fold, stainless steel	–	1724-866K	2CKA001754A4320		0.14	1
5-fold, stainless steel	–	1725-866K	2CKA001754A4321		0.175	1

ABB i-bus® KNX

User Operation – Design Ranges – Frames



1722-283

Frames, axcent®

For vertical and horizontal installation.

Description	Mod. width	Order details		Price	Weight	Pack
		Type code	Order code	1 piece	1 piece	unit
				€	kg	pc.
1-fold, platinum	–	1721-270	2CKA001754A4683		0.049	1
1-fold, black mat	–	1721-275	2CKA001754A4703		0.049	1
1-fold, titanium	–	1721-276	2CKA001754A4693		0.049	1
1-fold, black	–	1721-281	2CKA001754A4409		0.041	10
1-fold, brown glass	–	1721-283	2CKA001754A4543		0.131	1
1-fold, davos/studio white	–	1721-284	2CKA001754A4331		0.038	10
1-fold, yellow	–	1721-285	2CKA001754A4334		0.041	10
1-fold, green	–	1721-286	2CKA001754A4337		0.041	10
1-fold, red	–	1721-287	2CKA001754A4340		0.041	10
1-fold, blue	–	1721-288	2CKA001754A4343		0.041	10
1-fold, white glass	–	1721-280	2CKA001754A4437		0.095	1
1-fold, entrée-grey	–	1721-291-500	2CKA001754A4471		0.041	10
1-fold, château-black	–	1721-295-500	2CKA001754A4491		0.041	10
1-fold, maison-beige	–	1721-299-500	2CKA001754A4481		0.041	10
2-fold, platinum	–	1722-270	2CKA001754A4684		0.073	1
2-fold, black mat	–	1722-275	2CKA001754A4704		0.073	1
2-fold, titanium	–	1722-276	2CKA001754A4694		0.073	1
2-fold, black	–	1722-281	2CKA001754A4410		0.054	10
2-fold, brown glass	–	1722-283	2CKA001754A4544		0.195	1
2-fold, davos/studio white	–	1722-284	2CKA001754A4332		0.055	10
2-fold, yellow	–	1722-285	2CKA001754A4335		0.055	10
2-fold, green	–	1722-286	2CKA001754A4338		0.055	10
2-fold, red	–	1722-287	2CKA001754A4341		0.055	10
2-fold, blue	–	1722-288	2CKA001754A4344		0.055	10
2-fold, white glass	–	1722-280	2CKA001754A4438		0.115	1
2-fold, entrée-grey	–	1722-291-500	2CKA001754A4472		0.055	10
2-fold, château-black	–	1722-295-500	2CKA001754A4492		0.055	10
2-fold, maison-beige	–	1722-299-500	2CKA001754A4482		0.055	10
3-fold, platinum	–	1723-270	2CKA001754A4685		0.100	1
3-fold, black mat	–	1723-275	2CKA001754A4705		0.100	1
3-fold, titanium	–	1723-276	2CKA001754A4695		0.100	1
3-fold, black	–	1723-281	2CKA001754A4411		0.073	10
3-fold, brown glass	–	1723-283	2CKA001754A4545		0.261	1
3-fold, davos/studio white	–	1723-284	2CKA001754A4333		0.073	10
3-fold, yellow	–	1723-285	2CKA001754A4336		0.073	10
3-fold, green	–	1723-286	2CKA001754A4339		0.073	10
3-fold, red	–	1723-287	2CKA001754A4342		0.073	10
3-fold, blue	–	1723-288	2CKA001754A4345		0.073	10
3-fold, white glass	–	1723-280	2CKA001754A4439		0.261	1
3-fold, entrée-grey	–	1723-291-500	2CKA001754A4473		0.073	10
3-fold, château-black	–	1723-295-500	2CKA001754A4493		0.073	10
3-fold, maison-beige	–	1723-299-500	2CKA001754A4483		0.073	10

Continuation of table "Frames, axcent" on next page

Continuation of table "Frames, axcent"

Description	Mod. width	Order details		Price	Weight	Pack
		Type code	Order code	1 piece	1 piece	unit
				€	kg	pc.
4-fold, platinum	-	1724-270	2CKA001754A4686		0.126	1
4-fold, black mat	-	1724-275	2CKA001754A4706		0.126	1
4-fold, titanium	-	1724-276	2CKA001754A4696		0.126	1
4-fold, black	-	1724-281	2CKA001754A4412		0.117	1
4-fold, brown glass	-	1724-283	2CKA001754A4546		0.328	1
4-fold, davos/studio white	-	1724-284	2CKA001754A4346		0.117	1
4-fold, yellow	-	1724-285	2CKA001754A4348		0.117	1
4-fold, green	-	1724-286	2CKA001754A4350		0.117	1
4-fold, red	-	1724-287	2CKA001754A4352		0.117	1
4-fold, blue	-	1724-288	2CKA001754A4354		0.117	1
4-fold, white glass	-	1724-280	2CKA001754A4440		0.328	1
4-fold, entrée-grey	-	1724-291-500	2CKA001754A4474		0.117	1
4-fold, château-black	-	1724-295-500	2CKA001754A4494		0.117	1
4-fold, maison-beige		1724-299-500	2CKA001754A4484		0.117	1
5-fold, platinum	-	1725-270	2CKA001754A4687		0.150	1
5-fold, black mat	-	1725-275	2CKA001754A4707		0.150	1
5-fold, titanium	-	1725-276	2CKA001754A4697		0.150	1
5-fold, black	-	1725-281	2CKA001754A4413		0.145	1
5-fold, brown glass	-	1725-283	2CKA001754A4547		0.38	1
5-fold, davos/studio white	-	1725-284	2CKA001754A4347		0.145	1
5-fold, yellow	-	1725-285	2CKA001754A4349		0.145	1
5-fold, green	-	1725-286	2CKA001754A4351		0.145	1
5-fold, red	-	1725-287	2CKA001754A4353		0.145	1
5-fold, blue	-	1725-288	2CKA001754A4355		0.145	1
5-fold, white glass	-	1725-280	2CKA001754A4441		0.38	1
5-fold, entrée-grey	-	1725-291-500	2CKA001754A4475		0.145	1
5-fold, château-black	-	1725-295-500	2CKA001754A4495		0.145	1
5-fold, maison-beige	-	1725-299-500	2CKA001754A4485		0.145	1

ABB i-bus® KNX

User Operation – Design Ranges – Frames



1721-838-500

Frames, Dynasty®

For vertical and horizontal installation.

Description	Mod. width	Order details		Price	Weight	Pack
		Type code	Order code	1 piece	1 piece	unit
				€	kg	pc.
1-fold, polished brass ivory	–	1721-838-500	2CKA001754A4560		0.28	1
1-fold, polished brass anthracite	–	1721-835-500	2CKA001754A4565		0.28	1
1-fold, polished brass decor ivory	–	1721-836-500	2CKA001754A4570		0.28	1
1-fold, polished brass decor anthracite	–	1721-833-500	2CKA001754A4575		0.286	1
1-fold, antique brass ivory	–	1721-848-500	2CKA001754A4580		0.28	1
1-fold, antique brass anthracite	–	1721-845-500	2CKA001754A4585		0.3	1
1-fold, antique brass decor ivory	–	1721-846-500	2CKA001754A4590		0.3	1
1-fold, antique brass decor anthracite	–	1721-843-500	2CKA001754A4595		0.3	1
1-fold, ivory	–	1721-832-500	2CKA001754A4600		0.042	1
1-fold, anthracite	–	1721-831-500	2CKA001754A4605		0.042	1
2-fold, polished brass ivory	–	1722-838-500	2CKA001754A4561		0.42	1
2-fold, polished brass anthracite	–	1722-835-500	2CKA001754A4566		0.42	1
2-fold, polished brass decor ivory	–	1722-836-500	2CKA001754A4571		0.42	1
2-fold, polished brass decor anthracite	–	1722-833-500	2CKA001754A4576		0.42	1
2-fold, antique brass ivory	–	1722-848-500	2CKA001754A4581		0.44	1
2-fold, antique brass anthracite	–	1722-845-500	2CKA001754A4586		0.44	1
2-fold, antique brass decor ivory	–	1722-846-500	2CKA001754A4591		0.42	1
2-fold, antique brass decor anthracite	–	1722-843-500	2CKA001754A4596		0.44	1
2-fold, ivory	–	1722-832-500	2CKA001754A4601		0.064	1
2-fold, anthracite	–	1722-831-500	2CKA001754A4606		0.064	1
3-fold, polished brass ivory	–	1723-838-500	2CKA001754A4562		0.54	1
3-fold, polished brass anthracite	–	1723-835-500	2CKA001754A4567		0.54	1
3-fold, polished brass decor ivory	–	1723-836-500	2CKA001754A4572		0.56	1
3-fold, polished brass decor anthracite	–	1723-833-500	2CKA001754A4577		0.56	1
3-fold, antique brass ivory	–	1723-848-500	2CKA001754A4582		0.56	1
3-fold, antique brass anthracite	–	1723-845-500	2CKA001754A4587		0.54	1
3-fold, antique brass decor ivory	–	1723-846-500	2CKA001754A4592		0.56	1
3-fold, antique brass decor anthracite	–	1723-843-500	2CKA001754A4597		0.56	1
3-fold, ivory	–	1723-832-500	2CKA001754A4602		0.096	1
3-fold, anthracite	–	1723-831-500	2CKA001754A4607		0.096	1

Continuation of table "Frames, Dynasty®" on next page

Continuation of table "Frames, Dynasty®"

Description	Mod. width	Order details		Price	Weight	Pack
		Type code	Order code	1 piece	1 piece	unit
				€	kg	pc.
4-fold, polished brass ivory	-	1724-838-500	2CKA001754A4563		0.7	1
4-fold, polished brass anthracite	-	1724-835-500	2CKA001754A4568		0.7	1
4-fold, polished brass decor ivory	-	1724-836-500	2CKA001754A4573		0.7	1
4-fold, polished brass decor anthracite	-	1724-833-500	2CKA001754A4578		0.7	1
4-fold, antique brass ivory	-	1724-848-500	2CKA001754A4583		0.72	1
4-fold, antique brass anthracite	-	1724-845-500	2CKA001754A4588		0.7	1
4-fold, antique brass decor ivory	-	1724-846-500	2CKA001754A4593		0.7	1
4-fold, antique brass decor anthracite	-	1724-843-500	2CKA001754A4598		0.72	1
4-fold, ivory	-	1724-832-500	2CKA001754A4603		0.28	1
4-fold, anthracite	-	1724-831-500	2CKA001754A4608		0.28	1
5-fold, polished brass ivory	-	1725-838-500	2CKA001754A4564		0.82	1
5-fold, polished brass anthracite	-	1725-835-500	2CKA001754A4569		0.82	1
5-fold, polished brass decor ivory	-	1725-836-500	2CKA001754A4574		0.82	1
5-fold, polished brass decor anthracite	-	1725-833-500	2CKA001754A4579		0.82	1
5-fold, antique brass ivory	-	1725-848-500	2CKA001754A4584		0.84	1
5-fold, antique brass anthracite	-	1725-845-500	2CKA001754A4589		0.82	1
5-fold, antique brass decor ivory	-	1725-846-500	2CKA001754A4594		0.84	1
5-fold, antique brass decor anthracite	-	1725-843-500	2CKA001754A4599		0.84	1
5-fold, ivory	-	1725-832-500	2CKA001754A4604		0.34	1
5-fold, anthracite	-	1725-831-500	2CKA001754A4609		0.34	1

ABB i-bus® KNX

User Operation – Design Ranges – Busch-triton®

With freely programmable switch rockers, backlit label fields and IR sensor Busch-triton® is ideal for any application and with its elegant design it is commonly installed in hotels and pub-

lic areas. Busch-triton® is equipped with an integrated bus coupler and IR receiver. The unit composed of control element and integrated bus coupler now really has everything required to

control building systems elegantly and comfortably.



01



01 1/2 gang control element with rear-illuminated labelling area and IR reception

Function

Switching | Dimming | Blinds | Value transmitter | Value dimming sensor | Light scene extension unit | Step-type switch | Short/long operation | 13 freely programmable IR channels | 8 light scenes

Features

Labellable switch rockers | Rear-illuminated labelling field | Anti-theft protection | Freely programmable switches | IR remote-controllable | Freely programmable additional key

02



Function

Switching | Dimming | Blinds | Value transmitter | Value dimming sensor | Light scene extension unit | Step-type switch | Short/long operation | 13 freely programmable IR channels | 8 light scenes

Features

Labellable switch rockers | Rear-illuminated labelling field | Anti-theft protection | Freely programmable switches | IR remote-controllable

03



03 5/10 gang control element with rear-illuminated labelling area and IR reception

Function

Switching | Dimming | Blinds | Value transmitter | Value dimming sensor | Light scene extension unit | Step-type switch | Short/long operation | 13 freely programmable IR channels | 8 light scenes

Features

Labellable switch rockers | Rear-illuminated labelling field | Anti-theft protection | Freely programmable switches | IR remote-controllable | Freely programmable additional key

Colour-coordinated.

The Busch-triton® is available in five stunning colours, offering exactly the right ambience for any environment. The colours offer exactly the right accent to the carat®, impuls, alpha and future® linear ranges – such as the use of the colour-coordinated socket outlets or motion detectors.



01

**Function**

LCD display room temperature controller | Comfort | Stand-by | Night operation | Frost protection | Heating | Cooling | Fan control | Switching | Dimming | Blinds | Value | 13 freely programmable IR channels | 8 light scenes

Features

Labellable switch rockers | Rear-illuminated labelling field | Anti-theft protection | Freely programmable switches | IR remote-controllable | Freely programmable additional key

02

**Function**

LCD display room temperature controller | Comfort | Stand-by | Night operation | Frost protection | Heating | Cooling | Fan control | Switching | Dimming | Blinds | Value | 13 freely programmable IR channels | 8 light scenes

Features

Labellable switch rockers | Rear-illuminated labelling field | Anti-theft protection | Freely programmable switches | IR remote-controllable | Freely programmable additional key

- 01 3/6 gang control element with rear-illuminated labelling field, integrated room thermostat, LCD display and IR reception
- 02 5/10 gang control element with rear-illuminated labelling field, integrated room thermostat, LCD display and IR reception

ABB i-bus® KNX

User Operation – Design Ranges – Push Button Coupling Unit

The push-button coupling unit with a centre position offers maximum flexibility. Installed in a flush-mounted wall box, it accepts switch rockers from

conventional switch ranges* like a completely standard flush-mounted insert. Covers from all conventional ranges can now be used for KNX. This

offers maximum freedom in the selection of the switch range and makes retrofitting easier.

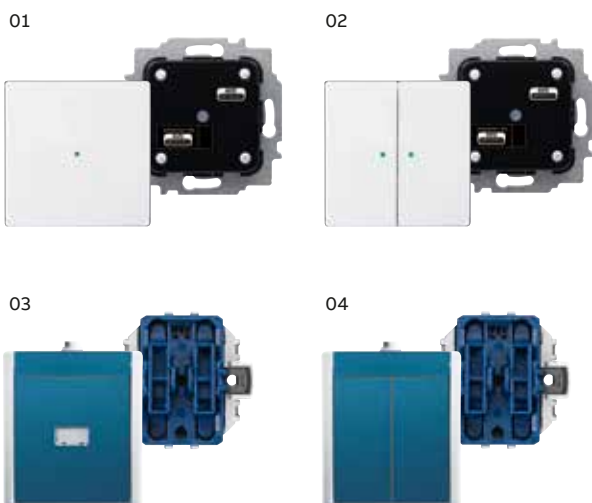

Features

- Easy mounting and uncomplicated commissioning
- All flush-mounted switch ranges* can be used for the ABB i-bus® KNX
- Affordable solution for renovations
- Status/orientation light (red/green/OFF)
- (only with 1 gang push-button/switches)
- Integration in surface-mounted water protected units

- 01 Push-button coupler 2 gang with integrated bus coupler
- 02 Push-button coupler 4 gang with integrated bus coupler
- 03 Push-button coupler 2 gang for ocean with integrated bus coupler
- 04 Push-button coupler 4 gang for ocean with integrated bus coupler



Design without limits. The push-button coupling unit includes the complete range* of switches for KNX. Switch rockers from all switch ranges can now be converted to KNX push buttons, which not only switch on and off but also dim or show the status with an LED (6108/01 and 6108/04 only). 1 gang and 2 gang models for single and 2 gang switch rockers are available.

KNX – water protected

The push-button coupling unit also allows special products to be used for KNX. Special models for water-protected installation allow covers from, for example, the ocean® surface-mounted range to be used. This means that KNX sensors can also be safely installed in a cellar, outside on a patio or in commercial applications. Temperature range: –25 °C to 45 °C.

*except impuls, basic55® and All Weather 44 Busch-Jaeger switch ranges only available for selected markets. For further information please contact your local ABB office.

ABB i-bus® KNX

User Operation – Design Ranges – Push Button Coupling Unit



6108/06-AP-500

Push-button coupler 2 gang with integrated bus coupler

For contacting conventional 1 gang rocker switches. With middle position. For inserting in the ocean surface-mounted housing. Enclosed mounting plate for the following ranges: Busch-Duro 2000 SI/SI Linear, Reflex SI/SI Linear, future® linear, alpha, solo®, Busch-axcent®, carat® and pure stainless steel. The bus can be connected via enclosed terminal block.

Description	Mod. width	Order details		Price	Weight	Pack unit
		Type code	Order code	1 piece	1 piece	
				€	kg	pc.
1/2-fold	–	6108/06-AP-500	2CKA006133A0225		0.1	1
2/4-fold	–	6108/07-AP-500	2CKA006133A0227		0.091	1



6108/06-500

Push-button coupler 2 gang with integrated bus coupler

For contacting 1 gang rocker 6230-10-xxx, 6231-10-xxx, 6232-10-xxx, 6233-10-xxx und 6234-10-xxx. With integrated temperature sensor. Support of KNX functions through innovative colour concept (yellow=lighting, blue=blind, orange=RTC, magenta=scene and white=neutral/no function assigned) or standard illumination red/green. With middle position. The bus connection is provided via the enclosed bus terminal.

Description	Mod. width	Order details		Price	Weight	Pack unit
		Type code	Order code	1 piece	1 piece	
				€	kg	pc.
	–	6108/06-500	2CKA006133A0221		0.06	1

ABB i-bus® KNX

User Operation – Design Ranges – Push Button Coupling Unit



SR-1-84

Rocker 1 gang, without printing

As cover for KNX 2 gang push-button coupling unit (6108/06-500).

Description	Mod. width	Order details		Price	Weight	Pack
		Type code	Order code	1 piece	1 piece	unit
				€	kg	pc.
Reflex SI						
white	–	SR-1-212	2CKA006220A0182		0.017	1
alpine white	–	SR-1-214	2CKA006220A0183		0.017	1
future® linear						
anthracite	–	SR-1-81	2CKA006220A0137		0.017	1
ivory	–	SR-1-82	2CKA006220A0516		0.018	1
aluminium silver	–	SR-1-83	2CKA006220A0138		0.017	1
studio white	–	SR-1-84	2CKA006220A0139		0.017	1
studio white matt	–	SR-1-884	2CKA006220A0601		0.018	1
black, matt	–	SR-1-885	2CKA006220A0618		0.018	1
solo®						
ivory	–	SR-1-82	2CKA006220A0516		0.018	1
studio white	–	SR-1-84	2CKA006220A0139		0.017	1
grey metallic	–	SR-1-803	2CKA006220A0550		0.018	1
Busch-axcent®						
studio white	–	SR-1-84	2CKA006220A0139		0.017	1
pure stainless steel						
stainless steel	–	SR-1-866	2CKA006220A0533		0.016	1
carat®						
anthracite	–	SR-1-81	2CKA006220A0137		0.017	1
ivory	–	SR-1-82	2CKA006220A0516		0.018	1
studio white	–	SR-1-84	2CKA006220A0139		0.017	1
Dynasty®						
anthracite	–	SR-1-81	2CKA006220A0137		0.017	1
ivory	–	SR-1-82	2CKA006220A0516		0.018	1
antique brass	–	SR-1-840	2CKA006220A0371		0.018	1



SRL-1-84

Rocker 1 gang, with "Light" icon

As cover for KNX 2 gang push-button coupling unit (6108/06-500).

Description	Mod. width	Order details		Price	Weight	Pack
		Type code	Order code	1 piece	1 piece	unit
				€	kg	pc.
Reflex SI						
white	-	SRL-1-212	2CKA006220A0184		0.013	1
alpine white	-	SRL-1-214	2CKA006220A0185		0.013	1
future® linear						
anthracite	-	SRL-1-81	2CKA006220A0140		0.017	1
ivory	-	SRL-1-82	2CKA006220A0517		0.014	1
aluminium silver	-	SRL-1-83	2CKA006220A0141		0.017	1
studio white	-	SRL-1-84	2CKA006220A0142		0.017	1
studio white matt	-	SRL-1-884	2CKA006220A0602		0.018	1
black, matt	-	SRL-1-885	2CKA006220A0619		0.018	1
solo®						
ivory	-	SRL-1-82	2CKA006220A0517		0.014	1
studio white	-	SRL-1-84	2CKA006220A0142		0.017	1
grey metallic	-	SRL-1-803	2CKA006220A0551		0.018	1
Busch-axcent®						
studio white	-	SRL-1-84	2CKA006220A0142		0.017	1
pure stainless steel						
stainless steel	-	SRL-1-866	2CKA006220A0534		0.014	1
carat®						
anthracite	-	SRL-1-81	2CKA006220A0140		0.017	1
ivory	-	SRL-1-82	2CKA006220A0517		0.014	1
studio white	-	SRL-1-84	2CKA006220A0142		0.017	1
Dynasty®						
anthracite	-	SRL-1-81	2CKA006220A0140		0.017	1
ivory	-	SRL-1-82	2CKA006220A0517		0.014	1
antique brass	-	SRL-1-840	2CKA006220A0372		0.018	1

ABB i-bus® KNX

User Operation – Design Ranges – Push Button Coupling Unit



SRB-1-84

Rocker 1 gang, with “Blind” icon

As cover for KNX 2 gang push-button coupling unit (6108/06-500).

Description	Mod. width	Order details		Price	Weight	Pack
		Type code	Order code	1 piece	1 piece	unit
				€	kg	pc.
Reflex SI						
white	–	SRB-1-212	2CKA006220A0186		0.013	1
alpine white	–	SRB-1-214	2CKA006220A0187		0.013	1
future® linear						
anthracite	–	SRB-1-81	2CKA006220A0143		0.013	1
ivory	–	SRB-1-82	2CKA006220A0518		0.014	1
aluminium silver	–	SRB-1-83	2CKA006220A0144		0.017	1
studio white	–	SRB-1-84	2CKA006220A0145		0.017	1
studio white matt	–	SRB-1-884	2CKA006220A0603		0.018	1
black, matt	–	SRB-1-885	2CKA006220A0620		0.018	1
solo®						
ivory	–	SRB-1-82	2CKA006220A0518		0.014	1
studio white	–	SRB-1-84	2CKA006220A0145		0.017	1
grey metallic	–	SRB-1-803	2CKA006220A0552		0.018	1
Busch-axcent®						
studio white	–	SRB-1-84	2CKA006220A0145		0.017	1
pure stainless steel						
stainless steel	–	SRB-1-866	2CKA006220A0535		0.014	1
carat®						
anthracite	–	SRB-1-81	2CKA006220A0143		0.013	1
ivory	–	SRB-1-82	2CKA006220A0518		0.014	1
studio white	–	SRB-1-84	2CKA006220A0145		0.017	1
Dynasty®						
anthracite	–	SRB-1-81	2CKA006220A0143		0.013	1
ivory	–	SRB-1-82	2CKA006220A0518		0.014	1
antique brass	–	SRB-1-840	2CKA006220A0373		0.018	1



SRS-1-84

Rocker 1 gang, with “Scene” icon

As cover for KNX 2 gang push-button coupling unit (6108/06-500).

Description	Mod. width	Order details		Price	Weight	Pack
		Type code	Order code	1 piece	1 piece	unit
				€	kg	pc.
Reflex SI						
white	-	SRS-1-212	2CKA006220A0188		0.013	1
alpine white	-	SRS-1-214	2CKA006220A0189		0.013	1
future® linear						
anthracite	-	SRS-1-81	2CKA006220A0146		0.017	1
ivory	-	SRS-1-82	2CKA006220A0519		0.014	1
aluminium silver	-	SRS-1-83	2CKA006220A0147		0.017	1
studio white	-	SRS-1-84	2CKA006220A0148		0.017	1
studio white matt	-	SRS-1-884	2CKA006220A0604		0.018	1
black, matt	-	SRS-1-885	2CKA006220A0621		0.018	1
solo®						
ivory	-	SRS-1-82	2CKA006220A0519		0.014	1
studio white	-	SRS-1-84	2CKA006220A0148		0.017	1
grey metallic	-	SRS-1-803	2CKA006220A0553		0.015	1
Busch-axcent®						
studio white	-	SRS-1-84	2CKA006220A0148		0.017	1
pure stainless steel						
stainless steel	-	SRS-1-866	2CKA006220A0536		0.01	1
carat®						
anthracite	-	SRS-1-81	2CKA006220A0146		0.017	1
ivory	-	SRS-1-82	2CKA006220A0519		0.014	1
studio white	-	SRS-1-84	2CKA006220A0148		0.017	1
Dynasty®						
anthracite	-	SRS-1-81	2CKA006220A0146		0.017	1
ivory	-	SRS-1-82	2CKA006220A0519		0.014	1
antique brass	-	SRS-1-840	2CKA006220A0374		0.018	1

ABB i-bus® KNX

User Operation – Design Ranges – Push Button Coupling Unit



SRD-1-84

Rocker 1 gang, with “Dimmer” icon

As cover for KNX 2 gang push-button coupling unit (6108/06-500).

Description	Mod. width	Order details		Price	Weight	Pack
		Type code	Order code	1 piece	1 piece	unit
				€	kg	pc.
Reflex SI						
white	–	SRD-1-212	2CKA006220A0190		0.013	1
alpine white	–	SRD-1-214	2CKA006220A0191		0.013	1
future® linear						
anthracite	–	SRD-1-81	2CKA006220A0149		0.017	1
ivory	–	SRD-1-82	2CKA006220A0520		0.014	1
aluminium silver	–	SRD-1-83	2CKA006220A0150		0.017	1
studio white	–	SRD-1-84	2CKA006220A0151		0.017	1
studio white matt	–	SRD-1-884	2CKA006220A0605		0.018	1
black, matt	–	SRD-1-885	2CKA006220A0622		0.018	1
solo®						
ivory	–	SRD-1-82	2CKA006220A0520		0.014	1
studio white	–	SRD-1-84	2CKA006220A0151		0.017	1
grey metallic	–	SRD-1-803	2CKA006220A0554		0.018	1
Busch-axcent®						
studio white	–	SRD-1-84	2CKA006220A0151		0.017	1
pure stainless steel						
stainless steel	–	SRD-1-866	2CKA006220A0537		0.018	1
carat®						
anthracite	–	SRD-1-81	2CKA006220A0149		0.017	1
ivory	–	SRD-1-82	2CKA006220A0520		0.014	1
studio white	–	SRD-1-84	2CKA006220A0151		0.017	1
Dynasty®						
anthracite	–	SRD-1-81	2CKA006220A0149		0.017	1
ivory	–	SRD-1-82	2CKA006220A0520		0.014	1
antique brass	–	SRD-1-840	2CKA006220A0375		0.018	1



6108/07-500

Push-button coupling 4 gang with integrated bus coupler

Support of KNX functions through innovative colour concept yellow = lighting, blue = blind, orange = RTC, magenta = scene and white = neutral/no function assigned) or standard illumination red/green. With middle position. The bus can be connected via enclosed terminal block.

Description	Mod. width	Order details		Price	Weight	Pack
		Type code	Order code	1 piece	1 piece	unit
				€	kg	pc.
	–	6108/07-500	2CKA006133A0223		0.075	1



SR-2-84



SRB-2-84

Pack unit pc.	Weight 1 pc. kg	Description	Rocker 2 gang left/right, without printing As cover for KNX 4 gang push-button coupling unit (6108/07-500).			Rocker 2 gang left/right, with "Blind" icon As cover for KNX 4 gang push-button coupling unit (6108/07-500).		
			Order details	Price 1 pc.		Order details	Price 1 pc.	
			Type	Order code	€	Type	Order code	€
		Reflex SI						
		white	SR-2-212	2CKA006220A0192		SRB-2-212	2CKA006220A0196	
		alpine white	SR-2-214	2CKA006220A0193		SRB-2-214	2CKA006220A0197	
		future® linear						
		anthracite	SR-2-81	2CKA006220A0152		SRB-2-81	2CKA006220A0158	
		ivory	SR-2-82	2CKA006220A0521		SRB-2-82	2CKA006220A0523	
		aluminium silver	SR-2-83	2CKA006220A0153		SRB-2-83	2CKA006220A0159	
		studio white	SR-2-84	2CKA006220A0154		SRB-2-84	2CKA006220A0160	
		studio white matt	SR-2-884	2CKA006220A0606		SRB-2-884	2CKA006220A0608	
		black, matt	SR-2-885	2CKA006220A0623		SRB-2-885	2CKA006220A0625	
		solo®						
		ivory	SR-2-82	2CKA006220A0521		SRB-2-82	2CKA006220A0523	
		studio white	SR-2-84	2CKA006220A0154		SRB-2-84	2CKA006220A0160	
		grey metallic	SR-2-803	2CKA006220A0555		SRB-2-803	2CKA006220A0557	
		Busch-axcent®						
		studio white	SR-2-84	2CKA006220A0154		SRB-2-84	2CKA006220A0160	
		pure stainless steel						
		stainless steel	SR-2-866	2CKA006220A0538		SRB-2-866	2CKA006220A0540	
		carat®						
		anthracite	SR-2-81	2CKA006220A0152		SRB-2-81	2CKA006220A0158	
		ivory	SR-2-82	2CKA006220A0521		SRB-2-82	2CKA006220A0523	
		studio white	SR-2-84	2CKA006220A0154		SRB-2-84	2CKA006220A0160	
		Dynasty®						
		anthracite	SR-2-81	2CKA006220A0152		SRB-2-81	2CKA006220A0158	
		ivory	SR-2-82	2CKA006220A0521		SRB-2-82	2CKA006220A0523	
		antique brass	SR-2-840	2CKA006220A0376		SRB-2-840	2CKA006220A0378	

ABB i-bus® KNX

User Operation – Design Ranges – Push Button Coupling Unit



SRL-2-L-84



SRL-2-R-84

Pack unit pc.	Weight 1 pc. kg	Description	Rocker 2 gang left, with "Light" icon As cover for KNX 4 gang push-button coupling unit (6108/07-500).			Rocker 2 gang right, with "Light" icon As cover for KNX 4 gang push-button coupling unit (6108/07-500).		
			Order details	Price 1 pc.	Order details	Price 1 pc.		
			Type	Order code	€	Type	Order code	€
		Reflex SI						
		white	SRL-2-L-212	2CKA006220A0194		SRL-2-R-212	2CKA006220A0202	
		alpine white	SRL-2-L-214	2CKA006220A0195		SRL-2-R-214	2CKA006220A0203	
		future® linear						
		anthracite	SRL-2-L-81	2CKA006220A0155		SRL-2-R-81	2CKA006220A0167	
		ivory	SRL-2-L-82	2CKA006220A0522		SRL-2-R-82	2CKA006220A0527	
		aluminium silver	SRL-2-L-83	2CKA006220A0156		SRL-2-R-83	2CKA006220A0168	
		studio white	SRL-2-L-84	2CKA006220A0157		SRL-2-R-84	2CKA006220A0169	
		studio white matt	SRL-2-L-884	2CKA006220A0607		SRL-2-R-884	2CKA006220A0612	
		black, matt	SRL-2-L-885	2CKA006220A0624		SRL-2-R-885	2CKA006220A0629	
		solo®						
		ivory	SRL-2-L-82	2CKA006220A0522		SRL-2-R-82	2CKA006220A0527	
		studio white	SRL-2-L-84	2CKA006220A0157		SRL-2-R-84	2CKA006220A0169	
		grey metallic	SRL-2-L-803	2CKA006220A0556		SRL-2-R-803	2CKA006220A0561	
		Busch-axcent®						
		studio white	SRL-2-L-84	2CKA006220A0157		SRL-2-R-84	2CKA006220A0169	
		pure stainless steel						
		stainless steel	SRL-2-L-866	2CKA006220A0539		SRL-2-R-866	2CKA006220A0544	
		carat®						
		anthracite	SRL-2-L-81	2CKA006220A0155		SRL-2-R-81	2CKA006220A0167	
		ivory	SRL-2-L-82	2CKA006220A0522		SRL-2-R-82	2CKA006220A0527	
		studio white	SRL-2-L-84	2CKA006220A0157		SRL-2-R-84	2CKA006220A0169	
		Dynasty®						
		anthracite	SRL-2-L-81	2CKA006220A0155		SRL-2-R-81	2CKA006220A0167	
		ivory	SRL-2-L-82	2CKA006220A0522		SRL-2-R-82	2CKA006220A0527	
		antique brass	SRL-2-L-840	2CKA006220A0377		SRL-2-R-840	2CKA006220A0381	



SRS-2-L-84



SRS-2-R-84

Pack unit pc.	Weight 1 pc. kg	Description	Rocker 2 gang left, with "Scene" icon As cover for KNX 4 gang push-button coupling unit (6108/07-500).			Rocker 2 gang right, with "Scene" icon As cover for KNX 4 gang push-button coupling unit (6108/07-500).		
			Order details	Price 1 pc.		Order details	Price 1 pc.	
			Type	Order code	€	Type	Order code	€
		Reflex SI						
		white	SRS-2-L-212	2CKA006220A0198		SRS-2-R-212	2CKA006220A0206	
		alpine white	SRS-2-L-214	2CKA006220A0199		SRS-2-R-214	2CKA006220A0207	
		future® linear						
		anthracite	SRS-2-L-81	2CKA006220A0161		SRS-2-R-81	2CKA006220A0173	
		ivory	SRS-2-L-82	2CKA006220A0524		SRS-2-R-82	2CKA006220A0528	
		aluminium silver	SRS-2-L-83	2CKA006220A0162		SRS-2-R-83	2CKA006220A0174	
		studio white	SRS-2-L-84	2CKA006220A0163		SRS-2-R-84	2CKA006220A0175	
		studio white matt	SRS-2-L-884	2CKA006220A0609		SRS-2-R-884	2CKA006220A0613	
		black, matt	SRS-2-L-885	2CKA006220A0626		SRS-2-R-885	2CKA006220A0630	
		solo®						
		ivory	SRS-2-L-82	2CKA006220A0524		SRS-2-R-82	2CKA006220A0528	
		studio white	SRS-2-L-84	2CKA006220A0163		SRS-2-R-84	2CKA006220A0175	
		grey metallic	SRS-2-L-803	2CKA006220A0558		SRS-2-R-803	2CKA006220A0562	
		Busch-axcent®						
		studio white	SRS-2-L-84	2CKA006220A0163		SRS-2-R-84	2CKA006220A0175	
		pure stainless steel						
		stainless steel	SRS-2-L-866	2CKA006220A0541		SRS-2-R-866	2CKA006220A0545	
		carat®						
		anthracite	SRS-2-L-81	2CKA006220A0161		SRS-2-R-81	2CKA006220A0173	
		ivory	SRS-2-L-82	2CKA006220A0524		SRS-2-R-82	2CKA006220A0528	
		studio white	SRS-2-L-84	2CKA006220A0163		SRS-2-R-84	2CKA006220A0175	
		Dynasty®						
		anthracite	SRS-2-L-81	2CKA006220A0161		SRS-2-R-81	2CKA006220A0173	
		ivory	SRS-2-L-82	2CKA006220A0524		SRS-2-R-82	2CKA006220A0528	
		antique brass	SRS-2-L-840	2CKA006220A0379		SRS-2-R-840	2CKA006220A0382	

ABB i-bus® KNX

User Operation – Design Ranges – Push Button Coupling Unit



SRD-2-L-84



SRD-2-R-84

Pack unit pc.	Weight 1 pc. kg	Description	Rocker 2 gang left, with “Dimmer” icon As cover for KNX 4 gang push-button coupling unit (6108/07-500).			Rocker 2 gang right, with “Dimmer” icon As cover for KNX 4 gang push-button coupling unit (6108/07-500).		
			Order details	Price 1 pc.		Order details	Price 1 pc.	
			Type	Order code	€	Type	Order code	€
		Reflex SI						
		white	SRD-2-L-212	2CKA006220A0200		SRD-2-R-212	2CKA006220A0261	
		alpine white	SRD-2-L-214	2CKA006220A0201		SRD-2-R-214	2CKA006220A0262	
		future® linear						
		anthracite	SRD-2-L-81	2CKA006220A0164		SRD-2-R-81	2CKA006220A0258	
		ivory	SRD-2-L-82	2CKA006220A0525		SRD-2-R-82	2CKA006220A0526	
		aluminium silver	SRD-2-L-83	2CKA006220A0165		SRD-2-R-83	2CKA006220A0259	
		studio white	SRD-2-L-84	2CKA006220A0166		SRD-2-R-84	2CKA006220A0260	
		studio white matt	SRD-2-L-884	2CKA006220A0610		SRD-2-R-884	2CKA006220A0611	
		black, matt	SRD-2-L-885	2CKA006220A0627		SRD-2-R-885	2CKA006220A0628	
		solo®						
		ivory	SRD-2-L-82	2CKA006220A0525		SRD-2-R-82	2CKA006220A0526	
		studio white	SRD-2-L-84	2CKA006220A0166		SRD-2-R-84	2CKA006220A0260	
		grey metallic	SRD-2-L-803	2CKA006220A0559		SRD-2-R-803	2CKA006220A0560	
		Busch-axcent®						
		studio white	SRD-2-L-84	2CKA006220A0166		SRD-2-R-84	2CKA006220A0260	
		pure stainless steel						
		stainless steel	SRD-2-L-866	2CKA006220A0542		SRD-2-R-866	2CKA006220A0543	
		carat®						
		anthracite	SRD-2-L-81	2CKA006220A0164		SRD-2-R-81	2CKA006220A0258	
		ivory	SRD-2-L-82	2CKA006220A0525		SRD-2-R-82	2CKA006220A0526	
		studio white	SRD-2-L-84	2CKA006220A0166		SRD-2-R-84	2CKA006220A0260	
		Dynasty®						
		anthracite	SRD-2-L-81	2CKA006220A0164		SRD-2-R-81	2CKA006220A0258	
		ivory	SRD-2-L-82	2CKA006220A0525		SRD-2-R-82	2CKA006220A0526	
		antique brass	SRD-2-L-840	2CKA006220A0380		SRD-2-R-840	2CKA006220A0383	

ABB i-bus® KNX

User Operation – Design Ranges



6108/60-500

Control Element, 6 gang with Universal Input, 5 gang

Control element with a maximum of 6 control functions and an RTC extension unit (slave). Primary function for calling up the main function. Status bar for indication/display of operating or RTC functions. Operation is carried out via cover plate 6108/61-xxx. With actual value temperature display. With display of set-value temperature. With universal input with: - max. of 5 binary inputs - 4 binary inputs and 1 analogue input for activating sensors with external power supply 1-10 V/0-10 V - 2 binary inputs and 1 analogue input for activating sensors with external power supply 1-10 V/0-10 V and an external temperature sensor PT1000 / T6226. The bus can be connected via enclosed terminal block.

Description	Mod. width	Order details		Price	Weight	Pack unit
		Type code	Order code	1 piece	1 piece	
				€	kg	pc.
	-	6108/60-500	2CKA006115A0454			1



6108/61-212-500

Cover Plate for KNX Control Element, 7 gang

As cover for control element, 7 gang (6108/60).

Description	Mod. width	Order details		Price	Weight	Pack unit
		Type code	Order code	1 piece	1 piece	
				€	kg	pc.
white	-	6108/61-212-500	2CKA006115A0474		0.012	1
alpine white	-	6108/61-214-500	2CKA006115A0475		0.012	1
platinum	-	6108/61-20-500	2CKA006115A0476		0.016	1
bronze	-	6108/61-21-500	2CKA006115A0477		0.016	1
ivory/white	-	6108/61-22G-500	2CKA006115A0478		0.016	1
studio white	-	6108/61-24G-500	2CKA006115A0480		0.016	1
palladium	-	6108/61-260-500	2CKA006115A0481		0.016	1
titanium	-	6108/61-266-500	2CKA006115A0482		0.016	1
anthracite	-	6108/61-81-500	2CKA006115A0483		0.018	1
ivory white	-	6108/61-82-500	2CKA006115A0484		0.018	1
aluminium silver	-	6108/61-83-500	2CKA006115A0485		0.018	1
studio white	-	6108/61-84-500	2CKA006115A0486		0.018	1
studio white matt	-	6108/61-884-500	2CKA006115A0487		0.018	1
black matt	-	6108/61-885-500	2CKA006115A0488		0.018	1
grey metallic	-	6108/61-803-500	2CKA006115A0489		0.02	1
stainless steel	-	6108/61-866-500	2CKA006115A0492		0.018	1



6108/61-914

Cover Plate, Control Element, 7 gang

As cover for control element, 7 gang (6108/60).

Description	Mod. width	Order details		Price	Weight	Pack unit
		Type code	Order code	1 piece	1 piece	
				€	kg	pc.
white	-	6108/61-914	2CKA006155A0115			1
stainless steel	-	6108/61-840-500	2CKA006155A0121		0.018	1

ABB i-bus® KNX

User Operation – Design Ranges



6109/05-500

Room Temperature Controller with 5 gang Universal Input, FM

Room temperature controller without “local control” and without internal temperature sensor. With universal input with: - max. of 5 binary inputs - 4 binary inputs and 1 analogue input for activating sensors with external power supply 1-10 V/0-10 V - 2 binary inputs and 1 analogue input for activating sensors with external power supply 1-10 V/0-10 V and an external temperature sensor PT1000 / T6226. Master/slave configuration. With base-load operation. The bus can be connected via enclosed terminal block. Class of temperature controller 1. Contribution to space heating energy efficiency 1,0%.

Description	Mod. width	Order details		Price	Weight	Pack
		Type code	Order code	1 piece	1 piece	unit
				€	kg	pc.
	-	6109/05-500	2CKA006181A0013		0.08	1



6109/08-500

Room Temperature Controller, Commercial, with 5 gang Universal Input, FM

Room thermostat without “local control” incl. insert for centre plate for cooling element. With universal input with: - max. of 5 binary inputs - 4 binary inputs and 1 analogue input for activating sensors with external power supply 1-10 V/0-10 V - 2 binary inputs and 1 analogue input for activating sensors with external power supply 1-10 V/0-10 V and an external temperature sensor PT1000 / T6226. Can only be used with a cover plate 2114-xxx or 6541-xxx, with the exception of 6541-20, -21.-260 and -266. Master/slave configuration. With base-load operation. The bus can be connected via enclosed terminal block. Class of temperature controller 1. Contribution to space heating energy efficiency 1,0%.

Description	Mod. width	Order details		Price	Weight	Pack
		Type code	Order code	1 piece	1 piece	unit
				€	kg	pc.
	-	6109/08-500	2CKA006134A0313		0.138	1



6541-84

Cover Plate for Room Temperature Controller, Commercial

For room temperature controller, commercial.

Description	Mod. width	Order details		Price	Weight	Pack
		Type code	Order code	1 piece	1 piece	unit
			€	kg	pc.	
future® linear						
anthracite	–	6541-81	2CKA006599A2882		0.022	10
savanna/ivory	–	6541-82	2CKA006599A2832		0.022	10
aluminium silver ¹⁾	–	6541-83	2CKA006599A2885		0.022	10
davos/studio white	–	6541-84	2CKA006599A2835		0.022	10
studio white, matt ¹⁾	–	6541-884	2CKA006599A2962		0.022	10
black matt ¹⁾	–	6541-885	2CKA006599A2967		0.022	10
solo®						
savanna/ivory	–	6541-82	2CKA006599A2832		0.022	10
davos/studio white	–	6541-84	2CKA006599A2835		0.022	10
meteor/grey metallic ¹⁾	–	6541-803	2CKA006599A2940		0.022	10
carat®						
anthracite	–	6541-81	2CKA006599A2882		0.022	10
savanna/ivory	–	6541-82	2CKA006599A2832		0.022	10
davos/studio white	–	6541-84	2CKA006599A2835		0.022	10
pure stainless steel ¹⁾						
stainless steel	–	6541-866	2CKA006599A2924		0.018	10
Busch-axcent®						
davos/studio white	–	6541-84	2CKA006599A2835		0.022	10
alpha						
ivory	–	6541-22G	2CKA006599A2795		0.02	10
studio white, matt	–	6541-24	2CKA006599A1557		0.02	10
studio white, high gloss	–	6541-24G	2CKA006599A2332		0.02	10
Platinum	–	6541-20	2CKA006599A1466		0.02	10
Bronze	–	6541-21	2CKA006599A1524		0.02	10
palladium	–	6541-260	2CKA006599A2853		0.02	10
titanium	–	6541-266	2CKA006599A2856		0.02	10
impuls						
alpine white	–	6541-74	2CKA006599A2076		0.019	
champagne metallic	–	6541-79	2CKA006599A2142		0.019	
ivory	–	6541-72	2CKA006599A2918		0.019	
studio white matt	–	6541-774	2CKA006599A2971		0.019	
black matt	–	6541-775	2CKA006599A2975		0.019	
aluminium silver	–	6541-783	2CKA006599A2919		0.019	
Busch-Duro 2000® SI						
white (SI-Series)	–	2114-212	2CKA006599A1193		0.016	10

¹⁾ Surface painted

ABB i-bus® KNX

User Operation – Design Ranges



2114-214

Cover Plate for Temperature Controller, Commercial

For room temperature controller, commercial.

Description	Mod. width	Order details		Price	Weight	Pack
		Type code	Order code	1 piece	1 piece	unit
				€	kg	pc.
Reflex SI						
alpine white (SI-Series)	–	2114-214-500	2CKA006599A3008		0.02	10

ABB i-bus® KNX

User Operation – Design Ranges – Room Temperature Controller



6108/18-500

Room thermostat, heating/cooling operation

Control element with room thermostat function for triggering the heating, ventilation and fan-coil actuators. For controlling commercially available valve drives. With display of set-value temperature. Master/slave configuration. With base-load operation. The bus can be connected via enclosed terminal block.

Description	Mod. width	Order details		Price	Weight	Pack unit
		Type code	Order code	1 piece	1 piece	
				€	kg	pc.
	–	6108/18-500	2CKA006134A0319		0.08	1



CP-FCC-212

Cover plate for fan coil controller

As cover for ABB-free@home® room temperature controller RTC-F-1. As cover for KNX room temperature controller (6108/18-500).

Description	Mod. width	Order details		Price	Weight	Pack unit
		Type code	Order code	1 piece	1 piece	
				€	kg	pc.
Reflex SI						
white	–	CP-FCC-212	2CKA006220A0245		0.012	1
alpine white	–	CP-FCC-214	2CKA006220A0246		0.012	1
future® linear						
anthracite	–	CP-FCC-81	2CKA006220A0242		0.016	1
ivory	–	CP-FCC-82	2CKA006220A0532		0.016	1
aluminium silver	–	CP-FCC-83	2CKA006220A0243		0.016	1
studio white	–	CP-FCC-84	2CKA006220A0244		0.015	1
studio white matt	–	CP-FCC-884	2CKA006220A0617		0.016	1
black, matt	–	CP-FCC-885	2CKA006220A0634		0.016	1
solo®						
ivory	–	CP-FCC-82	2CKA006220A0532		0.016	1
studio white	–	CP-FCC-84	2CKA006220A0244		0.015	1
grey metallic	–	CP-FCC-803	2CKA006220A0566		0.016	1
Busch-axcent®						
studio white	–	CP-FCC-84	2CKA006220A0244		0.015	1
pure stainless steel						
stainless steel	–	CP-FCC-866	2CKA006220A0549		0.016	1
carat®						
anthracite	–	CP-FCC-81	2CKA006220A0242		0.016	1
ivory	–	CP-FCC-82	2CKA006220A0532		0.016	1
studio white	–	CP-FCC-84	2CKA006220A0244		0.015	1
Dynasty®						
anthracite	–	CP-FCC-81	2CKA006220A0242		0.016	1
ivory	–	CP-FCC-82	2CKA006220A0532		0.016	1

ABB i-bus® KNX

User Operation – Design Ranges – Room Temperature Controller



6109/18-500

Room temperature controller with 5 gang universal input, FM

Control element with room thermostat function for triggering the heating, ventilation and fan-coil actuators. With display of set-value temperature, master/slave configuration and base load operation. With universal inputs: a) max. of 5 binary inputs b) 4 binary inputs and 1 analogue input for activating sensors with external power supply 1 – 10 V/0 – 10 V or c) 2 binary inputs and 1 analogue input for activating sensors with external power supply 1 – 10 V/0 – 10 V and an external temperature sensor PT1000/T6226.

Description	Mod. width	Order details		Price	Weight	Pack
		Type code	Order code	1 piece	1 piece	unit
				€	kg	pc.
	–	6109/18-500	2CKA006134A0315		0.144	1



6109/28-500

Room temperature controller with CO₂/moisture sensor, FM

Control element with room thermostat function and CO₂ moisture/air pressure sensor or triggering the heating, ventilation and fan-coil actuators. With display of set-value temperature, master/slave configuration and base load operation. With universal inputs: a) max. of 5 binary inputs b) 4 binary inputs and 1 analogue input for activating sensors with external power supply 1 – 10 V/0 – 10 V or c) 2 binary inputs and 1 analogue input for activating sensors with external power supply 1 – 10 V/0 – 10 V and an external temperature sensor PT1000/T6226.

Description	Mod. width	Order details		Price	Weight	Pack
		Type code	Order code	1 piece	1 piece	unit
				€	kg	pc.
	–	6109/28-500	2CKA006134A0317		0.122	1



6109/03-214-500

**Cover plate for room temperature controller or
room temperature controller with CO₂/moisture future® linear**

As cover for room temperature controller with/without CO₂/moisture sensor (6109/18 and 6109/28).

Description	Mod. width	Order details		Price	Weight	Pack
		Type code	Order code	1 piece	1 piece	unit
				€	kg	pc.
Reflex SI						
white	-	6109/03-212-500	2CKA006155A0051		0.018	1
alpine white	-	6109/03-214-500	2CKA006155A0052		0.018	1
future® linear						
anthracite	-	6109/03-81-500	2CKA006155A0060		0.018	1
ivory/white	-	6109/03-82-500	2CKA006155A0061		0.018	1
aluminium silver	-	6109/03-83-500	2CKA006155A0062		0.018	1
studio white	-	6109/03-84-500	2CKA006155A0063		0.018	1
studio white matt	-	6109/03-884-500	2CKA006155A0064		0.018	1
black, matt	-	6109/03-885-500	2CKA006155A0065		0.018	1
solo®						
ivory/white	-	6109/03-82-500	2CKA006155A0061		0.018	1
studio white	-	6109/03-84-500	2CKA006155A0063		0.018	1
grey metallic	-	6109/03-803-500	2CKA006155A0066		0.018	1
Busch-axcent®						
studio white	-	6109/03-84-500	2CKA006155A0063		0.018	1
pure stainless steel						
stainless steel	-	6109/03-866-500	2CKA006155A0069		0.018	1
carat®						
anthracite	-	6109/03-81-500	2CKA006155A0060		0.018	1
ivory/white	-	6109/03-82-500	2CKA006155A0061		0.018	1
studio white	-	6109/03-84-500	2CKA006155A0063		0.018	1
Dynasty®						
anthracite	-	6109/03-81-500	2CKA006155A0060		0.018	1
ivory/white	-	6109/03-82-500	2CKA006155A0061		0.018	1
antique brass	-	6109/03-840-500	2CKA006155A0114		0.018	1

ABB i-bus® KNX

User Operation – Design Ranges – Millennium

The Millennium collection is the first metal range to incorporate the KNX system, the most intelligent way of managing spaces and optimizing

performance in terms of energy savings. Millennium is based on a combinable concept which creates a very comprehensive range, suitable for

any types of needs. This makes it the ideal collection for all types of homes, hotels, offices and shops.



01



02



03



01 Switch Sensor 2 gang KNX

02 Switch Sensor 4 gang KNX

03 Switch Sensor 6 gang KNX

04 Switch Sensor 6 gang KNX with IR

05 Busch watchdog 180° KNX

06 Room Thermostat KNX

Function
Switching | Dimming | Blinds | Sending values | Scenes etc.

Features
Incl. 10 logic channels (light scene actuator | sequence actuator | logic gates, etc.)
Control element: Switch contacts
Display elements: LED to indicate the function

Function
Switching | Dimming | Blinds | Sending values | Scenes etc.

Features
Incl. 10 logic channels (light scene actuator | sequence actuator | logic gates, etc.)
Control element: Switch contacts
Display elements: LED to indicate the function

Function
Switching | Dimming | Blinds | Sending values | Scenes etc.

Features
Incl. 10 logic channels (light scene actuator | sequence actuator | logic gates, etc.)
Control element: Switch contacts
Display elements: LED to indicate the function

Wide range. Millennium range offers special mounting plates for KNX sensors to reduce the height and improve the aesthetics for ultra slim design. The KNX sensors allow to replace the buttons with desired symbols in order to adjust the sensors to

specific design and needs like light, blind, scene, RTC or fan coil. Millennium offers a wide and elegant choice of finishes in stainless steel material: from the Brush Stainless Steel, to the soft touch given by the Silk Black, and the luxury of the

sophisticated gold finishes, Matt Gold and Antique Gold. Moreover, the range is now extended with two glass colors: White and Black glass to cater the luxury segment.

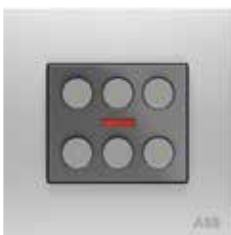

04

**Function**

Switching | Dimming | Blinds | Sending values | Scenes etc. | 6 gang sensor with IR.

Features

Incl. 10 logic channels (light scene actuator | sequence actuator | logic gates, etc.)
Control element: Switch contacts
Display elements: LED to indicate the function

05

**Function**

Movement sensor with up to four channels.
Detection range: frontal: 6 m, lateral: 6 m
Detection angle: 180 °
Brightness limit value: 5 Lux - 150 Lux
Mounting height: 1.1 m

06

**Function**

Control element with room thermostat function for triggering the heating, ventilation and fan-coil actuators. The controller is a thermostat for Fan Coil units in 2- and 4-pipe systems and conventional heating or cooling systems. The fan stage can be switched manually or in automatic mode.

The Millennium range is only available in the following countries: China, Dubai, India, Kuwait, Oman, Qatar, Saudi Arabia, Singapore, UAE and UK.
Frames and special mounting plates for KNX sensors have to be ordered by:
ABB, S.A.
Low Voltage Products-Niessen,
Oartzun / Spain
www.abb.es/niessen

Features

Incl. 10 logic channels (light scene actuator | sequence actuator | logic gates, etc.)

Switch contacts for operating mode selection and dial for setpoint or fan speed adjustment.
Display elements: LCD showing operation modes.
Protection class (Device): IP 20
Temperature range (Device): -5 °C to 45 °C

ABB i-bus® KNX

User Operation – Design Ranges – Millenium



6125/20-981-500

Switch Sensor 2 gang KNX

Incl. 10 logic channels (light scene actuator, sequence actuator, logic gates, etc.).
Control element: Switch contacts. Display elements: LED to indicate the function.
Protection class (Device): IP 20. Temperature range (Device): –5 °C to 45 °C.
Dimensions: (L x W x D): 53 mm x 44 mm.

Description	Mod. width	Order details		Price	Weight	Pack unit
		Type code	Order code	1 piece	1 piece	
				€	kg	pc.
	–	6125/20-981-500	2CKA006115A0443		0.083	1



6126/20-981-500

Switch Sensor 4 gang KNX

Incl. 10 logic channels (light scene actuator, sequence actuator, logic gates, etc.).
Control element: Switch contacts. Display elements: LED to indicate the function.
Protection class (Device): IP 20. Temperature range (Device): –5 °C to 45 °C.
Dimensions: (L x W x D): 53 mm x 44 mm.

Description	Mod. width	Order details		Price	Weight	Pack unit
		Type code	Order code	1 piece	1 piece	
				€	kg	pc.
	–	6126/20-981-500	2CKA006116A0218		0.084	1



6129/20-981-500

Switch Sensor 6 gang KNX

Incl. 10 logic channels (light scene actuator, sequence actuator, logic gates, etc.).
Control element: Switch contacts. Display elements: LED to indicate the function.
Protection class (Device): IP 20. Temperature range (Device): –5 °C to 45 °C.
Dimensions: (L x W x D): 53 mm x 44 mm.

Description	Mod. width	Order details		Price	Weight	Pack unit
		Type code	Order code	1 piece	1 piece	
				€	kg	pc.
	–	6129/20-981-500	2CKA006118A0104		0.085	1



6129/21-981-500

Switch Sensor 6 gang KNX with IR

Incl. 10 logic channels (light scene actuator, sequence actuator, logic gates, etc.).
Control element: Switch contacts. Display elements: LED to indicate the function.
Protection class (Device): IP 20. Temperature range (Device): –5 °C to 45 °C.
Dimensions: (L x W x D): 53 mm x 44 mm.

Description	Mod. width	Order details		Price	Weight	Pack unit
		Type code	Order code	1 piece	1 piece	
				€	kg	pc.
	–	6129/21-981-500	2CKA006118A0107		0.086	1



6122/20-981-500

Busch-Watchdog 180 flush mounted standard sensor

Movement sensor with up to four channels. Detection range: frontal: 6 m, lateral: 6 m. Detection angle: 180 °. Brightness limit value: 5 Lux – 150 Lux. Mounting height: 1.1 m. Protection class (Device): IP 20. Temperature range (Device): –5 °C to 45 °C. Dimensions: (L x W x D): 53 mm x 44 mm. Position for installation: vertical.

Description	Mod. width	Order details		Price	Weight	Pack unit
		Type code	Order code	1 piece	1 piece	
				€	kg	pc.
	–	6122/20-981-500	2CKA006132A0306		0.084	1



6124/08-981-500

Room Thermostat

Control element with room thermostat function for triggering the heating, ventilation and fan-coil actuators. The controller is a thermostat for Fan Coil units in 2- and 4-pipe systems and conventional heating or cooling systems. The fan stage can be switched manually or in automatic mode. Incl. 10 logic channels (light scene actuator, sequence actuator, logic gates, etc.).

Switch contacts for operating mode selection and dial for setpoint or fan speed adjustment. Display elements: LCD showing operation modes. Protection class (Device): IP 20. Temperature range (Device): –5 °C to 45 °C. Dimensions: (L x W x D): 53 mm x 44 mm.

Description	Mod. width	Order details		Price	Weight	Pack unit
		Type code	Order code	1 piece	1 piece	
				€	kg	pc.
	–	6124/08-981-500	2CKA006134A0309		0.101	1



Buttons with symbols

Buttons with symbols for Millenium control covers 1 / 2-gang, 2 / 4-gang, 3 / 6-gang and 3 / 6-gang with infrared.

Description	Mod. width	Order details		Price	Weight	Pack unit
		Type code	Order code	1 piece	1 piece	
				€	kg	pc.
Symbol for marking "Light"	–	6123/20-500	2CKA006123A0001		0.011	1
Symbol for marking "blinds"	–	6123/21-500	2CKA006123A0002		0.011	1
Symbol for marking "scene"	–	6123/22-500	2CKA006123A0003		0.011	1
Symbol for marking "temperature"	–	6123/23-500	2CKA006123A0004		0.011	1
Symbol for marking "ceiling light"	–	6123/24-500	2CKA006123A0005		0.003	1
Symbol for marking "Fan Coil"	–	6123/26-500	2CKA006123A0006		0.003	1

ABB i-bus® KNX

User Operation – Design Ranges – Millenium



Triple rocker / KNX frame 1 gang

Frame includes metal mounting plate. Dimensions 86 x 86 mm.

Description	Mod. width	Order details		Price	Weight	Pack unit
		Type code	Order code	1 piece	1 piece	
				€	kg	pc.
Stainless Steel	–	AMD5153-ST	2CLA637100N1101		0.109	10
Silk Black	–	AMD5153-SB	2CLA637100N1501		0.111	10
Antique Gold	–	AMD5153-AG	2CLA637100N1601		0.111	10
Matt Gold	–	AMD5153-MG	2CLA637100N1701		0.111	10
Dune Sand	–	AMD5153-DU	2CLA637100N6201		0.111	10
Mocha Brown	–	AMD5153-MO	2CLA637100N6601		0.111	10
White Glass	–	AMD5153-WG	2CLA637100N3001		0.205	10
Black Glass	–	AMD5153-BG	2CLA637100N3101		0.205	10

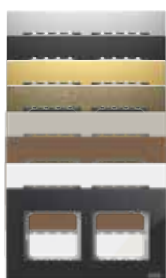

Triple rocker / KNX frame 2 gang

Frame includes metal mounting plate. Dimensions 86 x 147 mm.

Description	Mod. width	Order details		Price	Weight	Pack unit
		Type code	Order code	1 piece	1 piece	
				€	kg	pc.
Stainless Steel	–	AMD5253-ST	2CLA667200N1101		0.177	10
Silk Black	–	AMD5253-SB	2CLA667200N1501		0.177	10
Antique Gold	–	AMD5253-AG	2CLA667200N1601		0.176	10
Matt Gold	–	AMD5253-MG	2CLA667200N1701		0.178	10
Dune Sand	–	AMD5253-DU	2CLA667200N6201		0.177	10
Mocha Brown	–	AMD5253-MO	2CLA667200N6601		0.177	10
White Glass	–	AMD5253-WG	2CLA667200N3001		0.315	5
Black Glass	–	AMD5253-BG	2CLA667200N3101		0.315	5

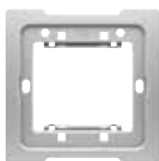

AMD5053

Special metal mounting plate for KNX sensors

Allows reduction height of KNX sensors to 1 mm. Only for following items: AMD72053-AN, AMD74053-AN, AMD76053-AN, AMD76153-AN.

Description	Mod. width	Order details		Price	Weight	Pack unit
		Type code	Order code	1 piece	1 piece	
				€	kg	pc.
Special metal mounting plate for KNX sensors 1 gang	–	AMD5053	2CLA627190N1001		0.032	1



TR/U 1.1

Transponder Reader, Millenium

The “transponder reader” is a flush-mounting device for British Standard wall boxes, designed to realize access control systems with a communication support based on KNX bus. It is equipped with one relay (4A @24 V AC/DC) and one input to be used for connecting external conventional card-holder (e.g. Millenium wiring accessories card-holder). The output can be programmed in three different ways: “Linked to access control”, receiving in this case switching commands from the device itself (according to transponder card validation); being a standard KNX Switch actuator output, able to be controlled by every KNX-standard devices; “linked to card-holder”, that means that the relay is switched according to closing/opening internal input contact available on transponder reader. The bicolor (red-green) LED placed on the front of the device allow you to monitor device operation and can be also switched ON/OFF in the proper color according to KNX telegram (for example for DND/MUR purposes).

The transponder reader requires a 12...24 V AC/DC external power supply to ensure its operation even with bus voltage failure.

The transponder reader is available for ABB Millenium wiring accessories range.

Description	Mod. width	Order details		Price	Weight	Pack
		Type code	Order code	1 piece	1 piece	unit
				€	kg	pc.
	-	TR/U 1.1	2CSY235683R2001		0.050	1



TH/U 1.1

Transponder Holder, Millenium

The “transponder holder” is a flush-mounting device for British Standard wall boxes, designed to realize access control systems with a communication support based on KNX bus. It is equipped with one relay (4A @24V AC/DC) and one binary input to be used for connecting external conventional push-button for switch, dimmer and shutter functionalities, or for example for connecting window contact or similar. The output can be programmed as “Linked to access control”, receiving in this case switching commands from the device itself (according to card insertion/removal); or being a standard KNX Switch actuator output, able to be controlled by every KNX-standard devices. The bicolor (red-green) LED placed on the front of the device allow you to monitor device operation and can be also switched ON/OFF in the proper color according to KNX.

The transponder reader requires a 12...24 V AC/DC external power supply to ensure its operation even with bus voltage failure.

The transponder reader is available for ABB Millenium wiring accessories range.

Description	Mod. width	Order details		Price	Weight	Pack
		Type code	Order code	1 piece	1 piece	unit
				€	kg	pc.
	-	TH/U 1.1	2CSY265232R2021		0.018	1

ABB i-bus® KNX

User Operation – Design Ranges – Millenium



TS/T 1
TS/T 1.1

Set of Transponder Cards for Millenium, Chiara 2 modules and tacteo design programs

The transponder card uses passive transponder technology operating in radio frequency (MIFARE technology), without the need for contact between the reader and the card itself. The transponder card is read by swiping it in front of the reader at a maximum distance of 20 mm (can be reduced according to installation environment).

Description	Mod. width	Order details		Price	Weight	Pack
		Type code	Order code	1 piece	1 piece	unit
				€	kg	pc.
10 transponder cards	–	TS/T 1	2CSY259412R2041		0.02	1
1000 transponder cards	–	TS/T 1.1	2CSY232175R2041		1	1



RoomGuard software

RoomGuard software

NEW

RoomGuard software for configuration and supervision of ABB Access Control range; Tacteo, Millenium, Zenit, Chiara and Mylos.

RoomGuard is a web-based scalable solution (licensing model based on number of rooms) accessible by any browser providing greater accessibility for hotel and maintenance staff. Main features and functionality include: Access control (management of keys, groups, time bands and staff cards, definition of access to common areas, and more), room state monitoring, guest check in/check out, front desk room load monitoring, management of guest and employee databases, Occupancy and access records and statistics, front desk management of room climate, and maintenance and diagnostics. RoomGuard features an intuitive and easy to use interface, with straightforward installation and configuration, seamless integration with building automation and third-party software integration.

RoomGuard software replaces MiniMAC software.

Available June 2023

Description	Mod. width	Order details		Price	Weight	Pack
		Type code	Order code	1 piece	1 piece	unit
				€	kg	pc.
RoomGuard software, 10 readers/rooms	–	RoomGuard-10	2CSY247450R0010		–	1
RoomGuard software, 20 readers/rooms	–	RoomGuard-20	2CSY244490R0020		–	1
RoomGuard software, 50 readers/rooms	–	RoomGuard-50	2CSY249580R0050		–	1
RoomGuard software, 100 readers/rooms	–	RoomGuard-100	2CSY242150R0100		–	1
RoomGuard software, 200 readers/rooms	–	RoomGuard-200	2CSY247240R0200		–	1
RoomGuard software, PMS interface	–	RoomGuard-PMS	2CSY244280R0999		–	1

ABB i-bus® KNX

User Operation – Design Ranges – Zenit



01



01 Switch Sensor 2 gang KNX

Function
Switching | Dimming | Blinds | Sending values | Scenes etc.

Features
Incl. 10 logic channels (light scene actuator | sequence actuator | logic gates, etc.)
Control element: Switch contacts
Display elements: LED to indicate the function

02



Function
Switching | Dimming | Blinds | Sending values | Scenes etc.

Features
Incl. 10 logic channels (light scene actuator | sequence actuator | logic gates, etc.)
Control element: Switch contacts
Display elements: LED to indicate the function

03



Function
Switching | Dimming | Blinds | Sending values | Scenes etc.

Features
Incl. 10 logic channels (light scene actuator | sequence actuator | logic gates, etc.)
Control element: Switch contacts
Display elements: LED to indicate the function

02 Switch Sensor 4 gang KNX

03 Switch Sensor 6 gang KNX

04 Switch Sensor 6 gang KNX with IR

05 Busch watchdog 180° KNX

06 Room Thermostat KNX

Zenit is based on a combinable concept which creates a very comprehensive range, suitable for any type of needs. Optimizing comfort, safety and efficiency of homes and buildings: Providing with complete com-

fort solutions to satisfy all type of needs and projects. Ensuring safety and protection of persons and goods. Saving energy by using only the amount of energy required.

Zenit offers two different mounting plates for KNX sensors corresponding to different market standards: VDE and NEMA.



04



Function

Switching | Dimming | Blinds | Sending values | Scenes etc. | 6 gang sensor with IR.

Features

Incl. 10 logic channels (light scene actuator | sequence actuator | logic gates, etc.)
Control element: Switch contacts
Display elements: LED to indicate the function

05



Function

Movement sensor with up to four channels.
Detection range: frontal: 6 m, lateral: 6 m
Detection angle: 180 °
Brightness limit value: 5 Lux - 150 Lux
Mounting height: 1.1 m

06



Function

Control element with room thermostat function for triggering the heating, ventilation and fan-coil actuators. The controller is a thermostat for Fan Coil units in 2- and 4-pipe systems and conventional heating or cooling systems. The fan stage can be switched manually or in automatic mode.

The Zenit VDE range is only available in the following countries:

Spain, Portugal, Russia, France

The Zenit NEMA range is only available in the following countries:

Latin America, Australia, Thailand, Vietnam.

Sensors, frames and special mounting plates for KNX sensors have to be ordered by: ABB, S.A.

Low Voltage Products-Niessen, Oartzun / Spain
www.abb.es/niessen

Features

Incl. 10 logic channels (light scene actuator | sequence actuator | logic gates, etc.)
Switch contacts for operating mode selection and dial for setpoint or fan speed adjustment.
Display elements: LCD showing operation modes.
Protection class (Device): IP 20
Temperature range (Device): -5 °C to +45 °C

ABB i-bus® KNX

User Operation – Design Ranges – Zenit



6125/98-509

1/2-fold sensor

Push switch function: switching / dimming / blind / sending values / scenes etc. Incl. 10 logic channels (light scene actuator, sequence actuator, logic gates, etc.). Control element: Switch contacts. Display elements: LED to indicate the function.

Description	Mod. width	Order details		Price	Weight	Pack
		Type code	Order code	1 piece	1 piece	unit
				€	kg	pc.
	–	6125/98-509	2CKA006115A0444		0.077	1

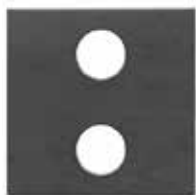

N2221.2

Cover Zenit 1/2-fold

Cover Zenit 1/2-fold. Available in white (BL), anthracite (AN) and silver (PL).

Description	Mod. width	Order details		Price	Weight	Pack
		Type code	Order code	1 piece	1 piece	unit
				€	kg	pc.
white	–	N2221.2 BL	2CLA222120N1101		0.038	1
anthracite	–	N2221.2 AN	2CLA222120N1801		0.038	1
silver	–	N2221.2 PL	2CLA222120N1301		0.038	1



6126/98-509

2/4-fold sensor

Push switch function: switching / dimming / blind / sending values / scenes etc. Incl. 10 logic channels (light scene actuator, sequence actuator, logic gates, etc.). Control element: Switch contacts. Display elements: LED to indicate the function.

Description	Mod. width	Order details		Price	Weight	Pack
		Type code	Order code	1 piece	1 piece	unit
				€	kg	pc.
	–	6126/98-509	2CKA006116A0219		0.079	1

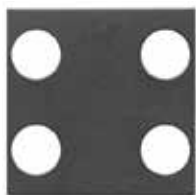

N2221.4

Cover Zenit 2/4-fold

Cover Zenit 2/4-fold. Available in white (BL), anthracite (AN) and silver (PL).

Description	Mod. width	Order details		Price	Weight	Pack
		Type code	Order code	1 piece	1 piece	unit
				€	kg	pc.
white	–	N2221.4 BL	2CLA222140N1101		0.038	1
anthracite	–	N2221.4 AN	2CLA222140N1801		0.038	1
silver	–	N2221.4 PL	2CLA222140N1301		0.038	1



6129/96-509

3/6-fold sensor

Push switch function: switching / dimming / blind / sending values / scenes etc. Incl.

10 logic channels (light scene actuator, sequence actuator, logic gates, etc.)

Control element: Switch contacts. Display elements: LED to indicate the function. Protection class (Device): IP 20. Temperature range (Device): -5 °C to 45 °C.

Dimensions: (L x W x D): 44 mm x 44 mm.

Description	Mod. width	Order details		Price	Weight	Pack
		Type code	Order code	1 piece	1 piece	unit
				€	kg	pc.
	-	6129/96-509	2CKA006118A0105		0.08	1

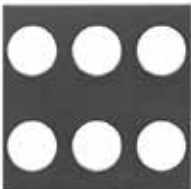

N2221.6

Cover Zenit 3/6-fold

Cover Zenit 3/6-fold. Available in white (BL), anthracite (AN) and silver (PL).

Description	Mod. width	Order details		Price	Weight	Pack
		Type code	Order code	1 piece	1 piece	unit
				€	kg	pc.
white	-	N2221.6 BL	2CLA222160N1101		0.011	1
anthracite	-	N2221.6 AN	2CLA222160N1801		0.011	1
silver	-	N2221.6 PL	2CLA222160N1301		0.011	1



6129/98-509

3/6-fold sensor with IR

Push switch function: switching / dimming / blind / sending values / scenes etc. Incl.

10 logic channels (light scene actuator, sequence actuator, logic gates, etc.). With infrared.

Control element: Switch contacts. Display elements: LED to indicate the function.

Description	Mod. width	Order details		Price	Weight	Pack
		Type code	Order code	1 piece	1 piece	unit
				€	kg	pc.
	-	6129/98-509	2CKA006118A0108		0.088	1



N2221.7

Cover Zenit 3/6-fold with IR

Cover Zenit 3/6-fold with IR. Available in white (BL), anthracite (AN) and silver (PL).

Description	Mod. width	Order details		Price	Weight	Pack
		Type code	Order code	1 piece	1 piece	unit
				€	kg	pc.
white	-	N2221.7 BL	2CLA222170N1101		0.011	1
anthracite	-	N2221.7 AN	2CLA222170N1801		0.011	1
silver	-	N2221.7 PL	2CLA222170N1301		0.011	1

ABB i-bus® KNX

User Operation – Design Ranges – Zenit



6124/88-509

Room thermostat heating / cooling Fan Coil

Control element with room thermostat function for triggering the heating, ventilation and fan-coil actuators. The controller is a thermostat for Fan Coil units in 2- and 4-pipe systems and conventional heating or cooling systems. The fan stage can be switched manually or in automatic mode. Incl. 10 logic channels (light scene actuator, sequence actuator, logic gates, etc.). Switch contacts for operating mode selection and dial for setpoint or fan speed adjustment. Display elements: LCD showing operation modes.

Description	Mod. width	Order details		Price	Weight	Pack unit
		Type code	Order code	1 piece	1 piece	
				€	kg	pc.
	–	6124/88-509	2CKA006134A0310		0.096	1



N2240.4

Cover Zenit room thermostat

Cover Zenit room thermostat. Available in white (BL), anthracite (AN) and silver (PL).

Description	Mod. width	Order details		Price	Weight	Pack unit
		Type code	Order code	1 piece	1 piece	
				€	kg	pc.
white	–	N2240.4 BL	2CLA224040N1101		0.028	1
anthracite	–	N2240.4 AN	2CLA224040N1801		0.028	1
silver	–	N2240.4 PL	2CLA224040N1301		0.028	1



6122/98-509

Watchdog 180 flush mounted

Movement sensor with up to four channels. Detection range: frontal: 6 m, lateral: 6 m. Detection angle: 180 °. Brightness limit value: 5 Lux – 150 Lux. Mounting height: 1.1 m.

Description	Mod. width	Order details		Price	Weight	Pack unit
		Type code	Order code	1 piece	1 piece	
				€	kg	pc.
	–	6122/98-509	2CKA006132A0307		0.09	1



N2241.4

Cover Zenit watchdog

Cover Zenit watchdog. Available in white (BL), anthracite (AN) and silver (PL).

Description	Mod. width	Order details		Price	Weight	Pack unit
		Type code	Order code	1 piece	1 piece	
				€	kg	pc.
white	–	N2241.4 BL	2CLA224140N1101		0.011	1
anthracite	–	N2241.4 AN	2CLA224140N1801		0.011	1
silver	–	N2241.4 PL	2CLA224140N1301		0.01	1



Buttons with symbols

Buttons with symbols for Zenit control covers 1 / 2-gang, 2 / 4-gang, 3 / 6-gang and 3 / 6-gang with infrared.

Description	Mod. width	Order details		Price	Weight	Pack unit
		Type code	Order code	1 piece	1 piece	
				€	kg	pc.
Symbol for marking "Light"	-	6123/20-500	2CKA006123A0001		0.011	10
Symbol for marking "blinds"	-	6123/21-500	2CKA006123A0002		0.011	10
Symbol for marking "scene"	-	6123/22-500	2CKA006123A0003		0.011	10
Symbol for marking "temperature"	-	6123/23-500	2CKA006123A0004		0.011	10
Symbol for marking "ceiling light"	-	6123/24-500	2CKA006123A0005		0.003	10
Symbol for marking "Fan Coil"	-	6123/26-500	2CKA006123A0006		0.003	10

Frames, 1 window, Zenit VDE



N2271 XX

Description	Mod. width	Order details		Price	Weight	Pack unit
		Type code	Order code	1 piece	1 piece	
				€	kg	pc.
white	-	N2271 BL	2CLA227100N1102		0.032	1
silver	-	N2271 PL	2CLA227100N1302		0.03	1
anthracite	-	N2271 AN	2CLA227100N1802		0.03	1
champagne	-	N2271 CV	2CLA227100N1902		0.031	1
wengué	-	N2271 WG	2CLA227100N2102		0.043	1
slate	-	N2271 PZ	2CLA227100N2202		0.92	1
white glass	-	N2271 CB	2CLA227100N3002		0.083	1
black glass	-	N2271 CN	2CLA227100N3102		0.083	1
pearl glass	-	N2271 CP	2CLA227100N3502		0.085	1
coffee glass	-	N2271 CC	2CLA227100N3702		0.083	1
graphite glass	-	N2271 CF	2CLA227100N3802		0.085	1
champagne glass	-	N2271 CH	2CLA227100N3902		0.085	1
stainless steel	-	N2271 OX	2CLA227100N4002		0.2	1

Basic frame, 1 window, Zenit VDE

Description	Mod. width	Order details		Price	Weight	Pack unit
		Type code	Order code	1 piece	1 piece	
				€	kg	pc.
white	-	N2271.1 BL	2CLA227110N1102		0.021	1
silver	-	N2271.1 PL	2CLA227110N1302		0.021	1
anthracite	-	N2271.1 AN	2CLA227110N1802		0.019	1
champagne	-	N2271.1 CV	2CLA227110N1902		0.02	1

ABB i-bus® KNX

User Operation – Design Ranges –
Zenit



N2272 BL

2 gang frames, Zenit VDE

Description	Mod. width	Order details		Price	Weight	Pack
		Type code	Order code	1 piece	1 piece	unit
				€	kg	pc.
white	–	N2272 BL	2CLA227200N1102		0.054	1
silver	–	N2272 PL	2CLA227200N1302		0.051	1
anthracite	–	N2272 AN	2CLA227200N1802		0.053	1
champagne	–	N2272 CV	2CLA227200N1902		0.052	1
wengué	–	N2272 WG	2CLA227200N2102		0.065	1
slate	–	N2272 PZ	2CLA227200N2202		0.154	1
white glass	–	N2272 CB	2CLA227200N3002		0.143	1
black glass	–	N2272 CN	2CLA227200N3102		0.136	1
pearl glass	–	N2272 CP	2CLA227200N3502		0.141	1
coffee glass	–	N2272 CC	2CLA227200N3702		0.142	1
graphite glass	–	N2272 CF	2CLA227200N3802		0.141	1
champagne glass	–	N2272 CH	2CLA227200N3902		0.14	1
stainless steel	–	N2272 OX	2CLA227200N4002		0.35	1



N2272.1 BL

2 gang frames – Basic, Zenit VDE

Description	Mod. width	Order details		Price	Weight	Pack
		Type code	Order code	1 piece	1 piece	unit
				€	kg	pc.
white	–	N2272.1 BL	2CLA227210N1102		0.036	1
silver	–	N2272.1 PL	2CLA227210N1302		0.035	1
anthracite	–	N2272.1 AN	2CLA227210N1802		0.034	1
champagne	–	N2272.1 CV	2CLA227210N1902		0.035	1



N2273 BL

3 gang frames, Zenit VDE

Description	Mod. width	Order details		Price	Weight	Pack
		Type code	Order code	1 piece	1 piece	unit
				€	kg	pc.
white	-	N2273 BL	2CLA227300N1102		0.08	1
silver	-	N2273 PL	2CLA227300N1302		0.079	1
anthracite	-	N2273 AN	2CLA227300N1802		0.079	1
champagne	-	N2273 CV	2CLA227300N1902		0.079	1
wengué	-	N2273 WG	2CLA227300N2102		0.099	1
slate	-	N2273 PZ	2CLA227300N2202		0.218	1
white glass	-	N2273 CB	2CLA227300N3002		0.2	1
black glass	-	N2273 CN	2CLA227300N3102		0.2	1
pearl glass	-	N2273 CP	2CLA227300N3502		0.2	1
coffee glass	-	N2273 CC	2CLA227300N3702		0.2	1
graphite glass	-	N2273 CF	2CLA227300N3802		0.2	1
champagne glass	-	N2273 CH	2CLA227300N3902		0.2	1
stainless steel	-	N2273 OX	2CLA227300N4002		0.52	1



N2273.1 BL

3 gang frames - Basic, Zenit VDE

Description	Mod. width	Order details		Price	Weight	Pack
		Type code	Order code	1 piece	1 piece	unit
				€	kg	pc.
white	-	N2273.1 BL	2CLA227310N1102		0.054	1
silver	-	N2273.1 PL	2CLA227310N1302		0.053	1
anthracite	-	N2273.1 AN	2CLA227310N1802		0.052	1
champagne	-	N2273.1 CV	2CLA227310N1902		0.055	1

ABB i-bus® KNX

User Operation – Design Ranges –
Zenit



N2274 BL

4 gang frames, Zenit VDE

Description	Mod. width	Order details		Price	Weight	Pack
		Type code	Order code	1 piece	1 piece	unit
				€	kg	pc.
white	–	N2274 BL	2CLA227400N1102		0.102	1
silver	–	N2274 PL	2CLA227400N1302		0.102	1
anthracite	–	N2274 AN	2CLA227400N1802		0.103	1
champagne	–	N2274 CV	2CLA227400N1902		0.103	1
wengué	–	N2274 WG	2CLA227400N2102		0.123	1
slate	–	N2274 PZ	2CLA227400N2202		0.278	1
white glass	–	N2274 CB	2CLA227400N3002		0.26	1
black glass	–	N2274 CN	2CLA227400N3102		0.261	1
pearl glass	–	N2274 CP	2CLA227400N3502		0.261	1
coffee glass	–	N2274 CC	2CLA227400N3702		0.261	1
graphite glass	–	N2274 CF	2CLA227400N3802		0.261	1
champagne glass	–	N2274 CH	2CLA227400N3902		0.261	1
stainless steel	–	N2274 OX	2CLA227400N4002		0.647	1



N2274.1 BL

4 gang frames – Basic, Zenit VDE

Description	Mod. width	Order details		Price	Weight	Pack
		Type code	Order code	1 piece	1 piece	unit
				€	kg	pc.
white	–	N2274.1 BL	2CLA227410N1102		0.07	1
silver	–	N2274.1 PL	2CLA227410N1302		0.07	1
anthracite	–	N2274.1 AN	2CLA227410N1802		0.069	1
champagne	–	N2274.1 CV	2CLA227410N1902		0.069	1



N2271.9

Metal mounting plate, Zenit VDE

Metal mounting plate for Zenit VDE KNX sensors.

Description	Mod. width	Order details		Price	Weight	Pack
		Type code	Order code	1 piece	1 piece	unit
				€	kg	pc.
2 windows	–	N2272.9	2CLA227290N1002		0.049	20



N2372.1 XX

Frame, 2 modules, Zenit, NEMA

Description	Mod. width	Order details		Price	Weight	Pack
		Type code	Order code	1 piece	1 piece	unit
				€	kg	pc.
white	-	N2372.1 BL	2CLA237210N1102		0.067	1
silver	-	N2372.1 PL	2CLA237210N1302		0.047	1
anthracite	-	N2372.1 AN	2CLA237210N1802		0.047	1
champagne	-	N2372.1 CV	2CLA237210N1902		0.047	1
slate	-	N2372.1 PZ	2CLA237200N2202		0.047	1
white glass	-	N2372.1 CB	2CLA237200N3002		0.124	1
black glass	-	N2372.1 CN	2CLA237200N3102		0.14	1
stainless steel	-	N2372.1 OX	2CLA237200N4002		0.278	1

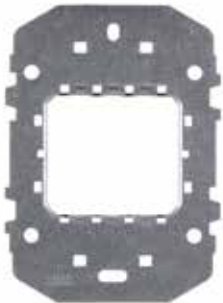

N2371.9V

Metal mounting plate

Mounting plate for 3 module box, facilitates the assembly of 1 and 2 module devices in vertical or horizontal installations.

Description	Mod. width	Order details		Price	Weight	Pack
		Type code	Order code	1 piece	1 piece	unit
				€	kg	pc.
for vertical installation	-	N2371.9V	2CLA237190N1002		0.054	20
for horizontal installation	-	N2373.9	2CLA237390N1002		0.036	20

ABB i-bus® KNX

User Operation – Design Ranges – Zenit



RS/U 1.1

KNX sensor, 1/2-gang, 1M

Push switch function: switching, dimming, blind or scene.

Display elements: LED to indicate the function.

To be installed with N2121, N2121.1, N2121.3, N2121.5, N2121.8, N2121.9 or N21 customized rockers.

Description	Mod. width	Order details		Price	Weight	Pack
		Type code	Order code	1 piece	1 piece	unit
				€	kg	pc.
	–	RS/U 1.1	2CSY244490R1012		0.11	1



RS/U 2.1

KNX sensor, 2/4-gang, 2M

Push switch function: switching, dimming, blind or scene.

Display elements: LED to indicate the function.

To be installed with N2121, N2121.1, N2121.3, N2121.5, N2121.8, N2121.9 or N21 customized rockers.

Description	Mod. width	Order details		Price	Weight	Pack
		Type code	Order code	1 piece	1 piece	unit
				€	kg	pc.
	–	RS/U 2.1	2CSY247450R1003		0.12	1



RA/U 1.16.1

KNX sensor/switch actuator, 2/1-gang, 2M

Push switch function: switching, dimming, blind or scene.

Display elements: LED to indicate the function.

Outputs: 1x potential free contact.

Rated current: 16 A.

To be installed with N2121, N2121.1, N2121.3, N2121.5, N2121.8, N2121.9 or N21 customized rockers.

Description	Mod. width	Order details		Price	Weight	Pack
		Type code	Order code	1 piece	1 piece	unit
				€	kg	pc.
	–	RA/U 1.16.1	2CSY249580R1103		0.12	1



RA/U 2.8.1

KNX sensor/switch actuator, 2/2-gang, 2M

Push switch function: switching, dimming, blind or scene.

Display elements: LED to indicate the function.

Outputs: 2x potential free contacts.

Rated current: 8 A.

To be installed with N2121, N2121.1, N2121.3, N2121.5, N2121.8, N2121.9 or N21 customized rockers.

Description	Mod. width	Order details		Price	Weight	Pack
		Type code	Order code	1 piece	1 piece	unit
				€	kg	pc.
	–	RA/U 2.8.1	2CSY242150R1106		0.12	1



RB/U 1.1

KNX sensor/blind actuator, 1/1-gang, 2M

Push switch function: switching, dimming, blind or scene.

Display elements: LED to indicate the function.

Outputs: 1x change-over contacts/potential-bound

Rated current: 8 A.

To be installed with N2221, N2221.1, N2221.3, N2221.5, N2221.8, N2221.9 or N22 customized rockers.

Description	Mod. width	Order details		Price	Weight	Pack
		Type code	Order code	1 piece	1 piece	unit
				€	kg	pc.
	-	RB/U 1.1	2CSY247240R1105		0.12	1



N2121 BL

Rocker cover without symbol, 1M

Rocker cover without symbol for KNX sensor/actuator.

Suitable for codes: RS/U 1.1 and left and right positions of RS/U 2.1, RA/U 1.16.1 and RA/U/ 2.8.1.

Description	Mod. width	Order details		Price	Weight	Pack
		Type code	Order code	1 piece	1 piece	unit
				€	kg	pc.
white - chrome	-	N2121 BL	2CLA212100N1101			10
full white	-	N2121 BB	2CLA212100N1201			10
silver - chrome	-	N2121 PL	2CLA212100N1301			10
full anthracite	-	N2121 AA	2CLA212100N1601			10
anthracite - chrome	-	N2121 AN	2CLA212100N1801			10
champagne - chrome	-	N2121 CV	2CLA212100N1901			10



N2221 BL

Rocker cover without symbol, 2M

Rocker cover without symbol for KNX sensor/actuator.

Suitable for codes: RB/U 1.1.

Description	Mod. width	Order details		Price	Weight	Pack
		Type code	Order code	1 piece	1 piece	unit
				€	kg	pc.
white - chrome	-	N2221 BL	2CLA222100N1101			10
full white	-	N2221 BB	2CLA222100N1201			10
silver - chrome	-	N2221 PL	2CLA222100N1301			10
full anthracite	-	N2221 AA	2CLA222100N1601			10
anthracite - chrome	-	N2221 AN	2CLA222100N1801			10
champagne - chrome	-	N2221 CV	2CLA222100N1901			10

ABB i-bus® KNX

User Operation – Design Ranges – Zenit



N2121.1 BL

Rocker cover with lamp symbol, 1M

Rocker cover without symbol for KNX sensor/actuator.

Suitable for codes: RB/U 1.1.

Description	Mod. width	Order details		Price	Weight	Pack unit
		Type code	Order code	1 piece	1 piece	
				€	kg	pc.
white - chrome	–	N2121.1 BL	2CLA212110N1101			10
full white	–	N2121.1 BB	2CLA212110N1201			10
silver - chrome	–	N2121.1 PL	2CLA212110N1301			10
full anthracite	–	N2121.1 AA	2CLA212110N1601			10
anthracite - chrome	–	N2121.1 AN	2CLA212110N1801			10
champagne - chrome	–	N2121.1 CV	2CLA212110N1901			10



N2121.1R BL

Rocker cover with lamp symbol, Right, 1M

Rocker cover with lamp symbol for KNX sensor/actuator.

Suitable for codes: right position of RS/U 2.1, RA/U 1.16.1 and RA/U/ 2.8.1.

Description	Mod. width	Order details		Price	Weight	Pack unit
		Type code	Order code	1 piece	1 piece	
				€	kg	pc.
white - chrome	–	N2121.1R BL	2CLA212112N1101			10
full white	–	N2121.1R BB	2CLA212112N1201			10
silver - chrome	–	N2121.1R PL	2CLA212112N1301			10
full anthracite	–	N2121.1R AA	2CLA212112N1601			10
anthracite - chrome	–	N2121.1R AN	2CLA212112N1801			10
champagne - chrome	–	N2121.1R CV	2CLA212112N1901			10

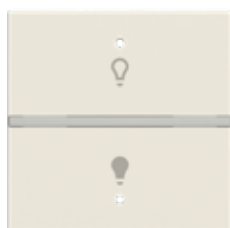

N2221.1 BL

Rocker cover with lamp symbol, 2M

Rocker cover with lamp symbol for KNX sensor/actuator.

Suitable for codes: RB/U 1.1.

Description	Mod. width	Order details		Price	Weight	Pack unit
		Type code	Order code	1 piece	1 piece	
				€	kg	pc.
white - chrome	–	N2221.1 BL	2CLA222110N1101			10
full white	–	N2221.1 BB	2CLA222110N1201			10
silver - chrome	–	N2221.1 PL	2CLA222110N1301			10
full anthracite	–	N2221.1 AA	2CLA222110N1601			10
anthracite - chrome	–	N2221.1 AN	2CLA222110N1801			10
champagne - chrome	–	N2221.1 CV	2CLA222110N1901			10



N2121.3 BL

Rocker cover with blind symbol, 1M

Rocker cover with blind symbol for KNX sensor/actuator.

Suitable for codes: RS/U 1.1 and left and right positions of RS/U 2.1, RA/U 1.16.1 and RA/U/ 2.8.1.

Description	Mod. width	Order details		Price	Weight	Pack unit
		Type code	Order code	1 piece	1 piece	
				€	kg	pc.
white - chrome	-	N2121.3 BL	2CLA212130N1101			10
full white	-	N2121.3 BB	2CLA212130N1201			10
silver - chrome	-	N2121.3 PL	2CLA212130N1301			10
full anthracite	-	N2121.3 AA	2CLA212130N1601			10
anthracite - chrome	-	N2121.3 AN	2CLA212130N1801			10
champagne - chrome	-	N2121.3 CV	2CLA212130N1901			10

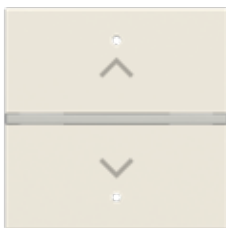

N2221.3 BL

Rocker cover with blind symbol, 2M

Rocker cover with blind symbol for KNX sensor/actuator.

Suitable for codes: RB/U 1.1.

Description	Mod. width	Order details		Price	Weight	Pack unit
		Type code	Order code	1 piece	1 piece	
				€	kg	pc.
white - chrome	-	N2221.3 BL	2CLA222130N1101			10
full white	-	N2221.3 BB	2CLA222130N1201			10
silver - chrome	-	N2221.3 PL	2CLA222130N1301			10
full anthracite	-	N2221.3 AA	2CLA222130N1601			10
anthracite - chrome	-	N2221.3 AN	2CLA222130N1801			10
champagne - chrome	-	N2221.3 CV	2CLA222130N1901			10



N2121.5 BL

Rocker cover with ON/OFF symbol, 1M

Rocker cover with ON/OFF symbol for KNX sensor/actuator.

Suitable for codes: RS/U 1.1 and left position of RS/U 2.1, RA/U 1.16.1 and RA/U/ 2.8.1.

Description	Mod. width	Order details		Price	Weight	Pack unit
		Type code	Order code	1 piece	1 piece	
				€	kg	pc.
white - chrome	-	N2121.5 BL	2CLA212150N1101			10
full white	-	N2121.5 BB	2CLA212150N1201			10
silver - chrome	-	N2121.5 PL	2CLA212150N1301			10
full anthracite	-	N2121.5 AA	2CLA212150N1601			10
anthracite - chrome	-	N2121.5 AN	2CLA212150N1801			10
champagne - chrome	-	N2121.5 CV	2CLA212150N1901			10

ABB i-bus® KNX

User Operation – Design Ranges – Zenit



N2121.5R BL

Rocker cover with ON/OFF symbol, Right, 1M

Rocker cover with ON/OFF symbol for KNX sensor/actuator.

Suitable for codes: right position of RS/U 2.1, RA/U1.16.1 and RA/U/ 2.8.1.

Description	Mod. width	Order details		Price	Weight	Pack unit
		Type code	Order code	1 piece	1 piece	
				€	kg	pc.
white - chrome	–	N2121.5R BL	2CLA212152N1101			10
full white	–	N2121.5R BB	2CLA212152N1201			10
silver - chrome	–	N2121.5R PL	2CLA212152N1301			10
full anthracite	–	N2121.5R AA	2CLA212152N1601			10
anthracite - chrome	–	N2121.5R AN	2CLA212152N1801			10
champagne - chrome	–	N2121.5R CV	2CLA212152N1901			10



N2221.5 BL

Rocker cover with ON/OFF symbol, 2M

Rocker cover with ON/OFF symbol for KNX sensor/actuator.

Suitable for codes: RB/U 1.1.

Description	Mod. width	Order details		Price	Weight	Pack unit
		Type code	Order code	1 piece	1 piece	
				€	kg	pc.
white - chrome	–	N2221.5 BL	2CLA222150N1101			10
full white	–	N2221.5 BB	2CLA222150N1201			10
silver - chrome	–	N2221.5 PL	2CLA222150N1301			10
full anthracite	–	N2221.5 AA	2CLA222150N1601			10
anthracite - chrome	–	N2221.5 AN	2CLA222150N1801			10
champagne - chrome	–	N2221.5 CV	2CLA222150N1901			10



N2121.8 BL

Rocker cover with dimmer symbol, 1M

Rocker cover with dimmer symbol for KNX sensor/actuator.

Suitable for codes: RS/U 1.1 and left position of RS/U 2.1, RA/U 1.16.1 and RA/U/ 2.8.1.

Description	Mod. width	Order details		Price	Weight	Pack unit
		Type code	Order code	1 piece	1 piece	
				€	kg	pc.
white - chrome	–	N2121.8 BL	2CLA212180N1101			10
full white	–	N2121.8 BB	2CLA212180N1201			10
silver - chrome	–	N2121.8 PL	2CLA212180N1301			10
full anthracite	–	N2121.8 AA	2CLA212180N1601			10
anthracite - chrome	–	N2121.8 AN	2CLA212180N1801			10
champagne - chrome	–	N2121.8 CV	2CLA212180N1901			10



N2121.8R BL

Rocker cover with dimmer symbol, Right, 1M

Rocker cover with dimmer symbol for KNX sensor/actuator.

Suitable for codes: right position of RS/U 2.1, RA/U1.16.1 and RA/U/ 2.8.1.

Description	Mod. width	Order details		Price	Weight	Pack
		Type code	Order code	1 piece	1 piece	unit
			€	kg	pc.	
white - chrome	-	N2121.8R BL	2CLA212182N1101			10
full white	-	N2121.8R BB	2CLA212182N1201			10
silver - chrome	-	N2121.8R PL	2CLA212182N1301			10
full anthracite	-	N2121.8R AA	2CLA212182N1601			10
anthracite - chrome	-	N2121.8R AN	2CLA222180N1801			10
champagne - chrome	-	N2121.8R CV	2CLA222180N1901			10



N2221.8 BL

Rocker cover with dimmer symbol, 2M

Rocker cover with dimmer symbol for KNX sensor/actuator.

Suitable for codes: RB/U 1.1.

Description	Mod. width	Order details		Price	Weight	Pack
		Type code	Order code	1 piece	1 piece	unit
			€	kg	pc.	
white - chrome	-	N2221.8 BL	2CLA222180N1101			10
full white	-	N2221.8 BB	2CLA222180N1201			10
silver - chrome	-	N2221.8 PL	2CLA222180N1301			10
full anthracite	-	N2221.8 AA	2CLA222180N1601			10
anthracite - chrome	-	N2221.8 AN	2CLA222180N1801			10
champagne - chrome	-	N2221.8 CV	2CLA222180N1901			10



N2121.9 BL

Rocker cover with scene symbol, 1M

Rocker cover with scene symbol for KNX sensor/actuator.

Suitable for codes: RS/U 1.1 and left position of RS/U 2.1, RA/U 1.16.1 and RA/U/ 2.8.1.

Description	Mod. width	Order details		Price	Weight	Pack
		Type code	Order code	1 piece	1 piece	unit
			€	kg	pc.	
white - chrome	-	N2121.9 BL	2CLA212190N1101			10
full white	-	N2121.9 BB	2CLA212190N1201			10
silver - chrome	-	N2121.9 PL	2CLA212190N1301			10
full anthracite	-	N2121.9 AA	2CLA212190N1601			10
anthracite - chrome	-	N2121.9 AN	2CLA212190N1801			10
champagne - chrome	-	N2121.9 CV	2CLA212190N1901			10

ABB i-bus® KNX

User Operation – Design Ranges – Zenit



N2121.9R BL

Rocker cover with scene symbol, Right, 1M

Rocker cover with scene symbol for KNX sensor/actuator.

Suitable for codes: right position of RS/U 2.1, RA/U 1.16.1 and RA/U/ 2.8.1.

Description	Mod. width	Order details		Price	Weight	Pack unit
		Type code	Order code	1 piece	1 piece	
				€	kg	pc.
white - chrome	–	N2121.9R BL	2CLA212192N1101			10
full white	–	N2121.9R BB	2CLA212192N1201			10
silver - chrome	–	N2121.9R PL	2CLA212192N1301			10
full anthracite	–	N2121.9R AA	2CLA212192N1601			10
anthracite - chrome	–	N2121.9R AN	2CLA212192N1801			10
champagne - chrome	–	N2121.9R CV	2CLA212192N1901			10



N2221.9 BL

Rocker cover with scene symbol, 2M

Rocker cover with scene symbol for KNX sensor/actuator.

Suitable for codes: RB/U 1.1.

Description	Mod. width	Order details		Price	Weight	Pack unit
		Type code	Order code	1 piece	1 piece	
				€	kg	pc.
white - chrome	–	N2221.9 BL	2CLA222190N1101			10
full white	–	N2221.9 BB	2CLA222190N1201			10
silver - chrome	–	N2221.9 PL	2CLA222190N1301			10
full anthracite	–	N2221.9 AA	2CLA222190N1601			10
anthracite - chrome	–	N2221.9 AN	2CLA222190N1801			10
champagne - chrome	–	N2221.9 CV	2CLA222190N1901			10



RT/U 1.1.ZW

KNX thermostat, 2M

Standard KNX thermostat equipped with backlight LCD display 4 push buttons on the front for the following functionalities (Operating mode switching, Fan-coil speed manual switching, set-point manual increment/decrement).

Possibility to choose different type of control: 2-point ON/OFF, PWM, Continue, Fan-coil.

Cover plate included.

Description	Mod. width	Order details		Price	Weight	Pack unit
		Type code	Order code	1 piece	1 piece	
				€	kg	pc.
white	–	RT/U 1.1.ZW	2CSY244280R1202		0.12	1
anthracite	–	RT/U 1.1.ZA	2CSY249370R1202		0.12	1
silver	–	RT/U 1.1.ZS	2CSY242280R1202		0.12	1
champagne	–	RT/U 1.1.ZC	2CSY247370R1202		0.12	1



TH/U 1.1.ZW

KNX transponder holder, 2M

The “transponder holder” is a flush-mounting device for British Standard wall boxes, designed to realize access control systems with a communication support based on KNX bus. It is equipped with one relay (4A @24V AC/DC) and one binary input to be used for connecting external conventional push-button for switch, dimmer and shutter functionalities, or for example for connecting window contact or similar. The output can be programmed as “Linked to access control”, receiving in this case switching commands from the device itself (according to card insertion/removal); or being a standard KNX Switch actuator output, able to be controlled by every KNX-standard devices. The white blinking LED placed on the front of the device allow you to monitor device operation and can be also switched ON/OFF in the proper color according to KNX. The transponder reader requires a 12...24 V AC/DC external power supply to ensure its operation even with bus voltage failure. Cover plate included.

Description	Mod. width	Order details		Price 1 piece	Weight 1 piece	Pack unit
		Type code	Order code			
white	–	TH/U 1.1.ZW	2CSY244340R5200		0.055	1
anthracite	–	TH/U 1.1.ZA	2CSY249430R5200		0.055	1
silver	–	TH/U 1.1.ZS	2CSY242070R5200		0.055	1
champagne	–	TH/U 1.1.ZC	2CSY247160R5200		0.055	1



TR/U 1.1.ZW

KNX transponder reader, 2M

The “transponder reader” is a flush-mounting device for British Standard wall boxes, designed to realize access control systems with a communication support based on KNX bus. It is equipped with one relay (4A @24 V AC/DC) and one input to be used for connecting external conventional card-holder (e.g. Zenit wiring accessories card-holder). The output can be programmed in three different ways: “Linked to access control”, receiving in this case switching commands from the device itself (according to transponder card validation); being a standard KNX Switch actuator output, able to be controlled by every KNXstandard devices; “linked to cardholder”, that means that the relay is switched according to closing/opening internal input contact available on transponder reader. The bicolor (red-green) LED placed on the front of the device allow you to monitor device operation and can be also switched ON/OFF in the proper color according to KNX telegram (for example for DND/MUR purposes). The transponder reader can be configured with ABB control software in order to behave as transponder programming device. The transponder reader requires a 12...24 V AC/DC external power supply to ensure its operation even with bus voltage failure. Cover plate included.

Description	Mod. width	Order details		Price 1 piece	Weight 1 piece	Pack unit
		Type code	Order code			
white	–	TR/U 1.1.ZW	2CSY244410R5000		0.055	1
anthracite	–	TR/U 1.1.ZA	2CSY249500R5000		0.055	1
silver	–	TR/U 1.1.ZS	2CSY242210R5000		0.055	1
champagne	–	TR/U 1.1.ZC	2CSY247300R5000		0.055	1

ABB i-bus® KNX

User Operation – Design Ranges – Mylos

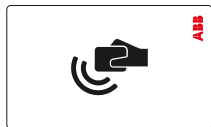

CH/T 2
CH/T 2.1

Set of 5 Transponder Cards for Chiara and Mylos design programs

The transponder card uses passive transponder technology operating in radio frequency, without the need for contact between the reader and the card itself. The transponder card is read by swiping it in front of the reader at a maximum distance of 20 mm.

Description	Mod. width	Order details		Price	Weight	Pack
		Type code	Order code	1 piece	1 piece	unit
				€	kg	pc.
5 transponder cards	–	CH/T 2	2CSKK5400C		0.005	1
1000 transponder cards	–	CH/T 2.1	2CSY289611R1941		1	1



SW MiniMAC 4.1

MiniMAC software

The management and configuration software ensures bidirectional communication with the access control system devices, allowing the system's configuration during its installation and its overall management and supervision.

Description	Mod. width	Order details		Price	Weight	Pack
		Type code	Order code	€	kg	pc.
	–	SW MiniMAC 4.1	2CSY258202R2051		0.005	1



RoomGuard software

RoomGuard software

RoomGuard software for configuration and supervision of ABB Access Control range; Tacteo, Millenium, Zenit, Chiara, and Mylos.

RoomGuard is a web-based scalable solution (licensing model based on number of rooms) accessible by any browser providing greater accessibility for hotel and maintenance staff. Main features and functionality include: Access control (management of keys, groups, time bands and staff cards, definition of access to common areas, and more), room state monitoring, guest check in/check out, front desk room load monitoring, management of guest and employee databases, Occupancy and access records and statistics, front desk management of room climate, and maintenance and diagnostics. RoomGuard features an intuitive and easy to use interface, with straightforward installation and configuration, seamless integration with building automation and third-party software integration.

RoomGuard software replaces MiniMAC software.

Available June 2023

Description	Mod. width	Order details		Price	Weight	Pack
		Type code	Order code	€	kg	pc.
RoomGuard software, 10 readers/rooms	–	RoomGuard-10	2CSY247450R0010		–	1
RoomGuard software, 20 readers/rooms	–	RoomGuard-20	2CSY244490R0020		–	1
RoomGuard software, 50 readers/rooms	–	RoomGuard-50	2CSY249580R0050		–	1
RoomGuard software, 100 readers/rooms	–	RoomGuard-100	2CSY242150R0100		–	1
RoomGuard software, 200 readers/rooms	–	RoomGuard-200	2CSY247240R0200		–	1
RoomGuard software, PMS interface	–	RoomGuard-PMS	2CSY244280R0999		–	1

Square Cover Plate

Mylos Etik

The design in perfect harmony with sustainability. Today, the development of a new product cannot ignore the impact on the environment in which we live. Every effort must be made with a view to obtaining an original but mainly sustainable result. ABB strongly believes in this commitment. And confirms this with Mylos Etik, the new finish that is good for all, including the environment.

Mylos Etik white and black



White



Black

Description	No. mod-ules	Order details		Price	Weight	Pack unit
		Type code	Order code	1 piece	1 piece	
				€	kg	pc.
white	2	2CSY0201QEP	2CSY0201QEP			1
white	3	2CSY0301QEP	2CSY0301QEP			1
white	4	2CSY0401QEP	2CSY0401QEP			1
black	2	2CSY0200QEP	2CSY0200QEP			1
black	3	2CSY0300QEP	2CSY0300QEP			1
black	4	2CSY0400QEP	2CSY0400QEP			1

ABB i-bus® KNX

User Operation – Design Ranges – Mylos

Mylos Lucent

A great adventure in luminosity.

If the need is to surround yourself with sparkling elements, the Lucent series is the most appropriate choice.

Made of special resins, each plate enhances with its glossy shades in every setting, like spots of light on Caravaggio canvases.

Mylos Lucent evokes elements such as alabaster and ice, also makes black shine, giving a technological aspect and thereby completing particularly high-tech spaces.

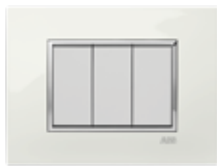

White alabaster

Lucent, White Alabaster.

Description	No. mod-ules	Order details		Price	Weight	Pack unit
		Type code	Order code	1 piece	1 piece	
				€	kg	pc.
	2	2CSY0201QGP	2CSY0201QGP		0.033	1
	3	2CSY0301QGP	2CSY0301QGP		0.054	1
	4	2CSY0401QGP	2CSY0401QGP		0.067	1
	7	2CSY0701QGP	2CSY0701QGP		0.108	1
	4+4	2CSY0801QGP	2CSY0801QGP		0.133	1



Brilliant black

Lucent, Brilliant black.

Description	No. mod-ules	Order details		Price	Weight	Pack unit
		Type code	Order code	1 piece	1 piece	
				€	kg	pc.
	2	2CSY0200QLP	2CSY0200QLP		0.033	1
	4	2CSY0400QLP	2CSY0400QLP		0.067	1
	7	2CSY0700QLP	2CSY0700QLP		0.108	1
	4+4	2CSY0800QLP	2CSY0800QLP		0.133	1



Ice

Lucent, Ice.

Description	No. mod-ules	Order details		Price	Weight	Pack unit
		Type code	Order code	1 piece	1 piece	
				€	kg	pc.
	2	2CSY0203QLP	2CSY0203QLP		0.033	1
	3	2CSY0303QLP	2CSY0303QLP		0.054	1
	4	2CSY0403QLP	2CSY0403QLP		0.067	1
	7	2CSY0703QLP	2CSY0703QLP		0.108	1
	4+4	2CSY0803QLP	2CSY0803QLP		0.133	1

Mylos Velvet

A touch of velvet in every gesture.

The Mylos Velvet finish draws inspiration from the creation of interiors in the automotive sector, a feather in the cap of Italian industrial tradition.

The technology applied to polymers makes it possible to obtain a matt scratchresistant finish and with an extraordinary soft tactile effect, just like velvet, to provide one's home with an original multisensorial elegance.



Graphite

Velvet, Graphite.

Description	No. mod-ules	Order details		Price	Weight	Pack
		Type code	Order code	1 piece	1 piece	unit
				€	kg	pc.
	2	2CSY0225QSP	2CSY0225QSP		0.033	1
	3	2CSY0325QSP	2CSY0325QSP		0.054	1
	4	2CSY0425QSP	2CSY0425QSP		0.067	1
	7	2CSY0725QSP	2CSY0725QSP		0.108	1
	4+4	2CSY0825QSP	2CSY0825QSP		0.133	1



White

Velvet, White.

Description	No. mod-ules	Order details		Price	Weight	Pack
		Type code	Order code	1 piece	1 piece	unit
				€	kg	pc.
	2	2CSY0224QMP	2CSY0224QMP		0.033	1
	3	2CSY0324QMP	2CSY0324QMP		0.054	1
	4	2CSY0424QMP	2CSY0424QMP		0.067	1
	7	2CSY0724QMP	2CSY0724QMP		0.108	1
	4+4	2CSY0824QMP	2CSY0824QMP		0.133	1

ABB i-bus® KNX

User Operation – Design Ranges – Mylos

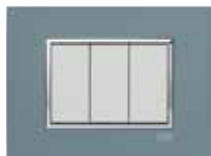

Cold grey

Velvet, Cold Grey.

Description	No. mod-ules	Order details		Price	Weight	Pack unit
		Type code	Order code	1 piece	1 piece	
				€	kg	pc.
	2	2CSY0222QSP	2CSY0222QSP		0.033	1
	3	2CSY0322QSP	2CSY0322QSP		0.054	1
	4	2CSY0422QSP	2CSY0422QSP		0.067	1
	7	2CSY0722QSP	2CSY0722QSP		0.108	1
	4+4	2CSY0822QSP	2CSY0822QSP		0.133	1



Black

Velvet, Black.

Description	No. mod-ules	Order details		Price	Weight	Pack unit
		Type code	Order code	1 piece	1 piece	
				€	kg	pc.
	2	2CSY0223QSP	2CSY0223QSP		0.033	1
	3	2CSY0323QSP	2CSY0323QSP		0.054	1
	4	2CSY0423QSP	2CSY0423QSP		0.067	1
	7	2CSY0723QSP	2CSY0723QSP		0.108	1
	4+4	2CSY0823QSP	2CSY0823QSP		0.133	1



Anthracite

Velvet, Anthracite.

Description	No. mod-ules	Order details		Price	Weight	Pack unit
		Type code	Order code	1 piece	1 piece	
				€	kg	pc.
	2	2CSY0226QSP	2CSY0226QSP		0.033	1
	3	2CSY0326QSP	2CSY0326QSP		0.054	1
	4	2CSY0426QSP	2CSY0426QSP		0.067	1
	7	2CSY0726QSP	2CSY0726QSP		0.108	1
	4+4	2CSY0826QSP	2CSY0826QSP		0.133	1

ABB i-bus® KNX

User Operation – Design Ranges – Chiara



2CSKK1002C

Binary Input, 2-fold, with Rocker Switch

Device equipped with: 1 rocker switch; 2 binary input channels that can be used to interface to KNX system conventional push-buttons/rocker switches, or auxiliary/technical contacts. LEDs for the functional signaling of the load to which the rocker switch is connected. Flush-mounted installation.

Description	Mod. width	Order details		Price	Weight	Pack
		Type code	Order code	1 piece	1 piece	unit
white	–	2CSKK1002C	2CSK206571R1002		kg	pc.
					0.12	1



2CSKK1003C

Binary Input, 2-fold, with Rocker Switches, 2 gang

Device equipped with: 2 rocker switches; 2 binary input channels that can be used to interface to KNX system conventional push-buttons/rocker switches, or auxiliary/technical contacts. LEDs for the functional signaling of the load to which the rocker switch is connected. Flush-mounted installation.

Description	Mod. width	Order details		Price	Weight	Pack
		Type code	Order code	1 piece	1 piece	unit
white	–	2CSKK1003C	2CSK232195R1003		kg	pc.
						1



2CSKK1202C

Thermostat

Standard KNX thermostat equipped with backlight LCD display 4 push buttons on the front for the following functionalities (Operating mode switching, Fan-coil speed manual switching, set-point manual increment/decrement). Possibility to choose different type of control: 2-point ON/OFF, PWM, Continue, Fan-coil.

Description	Mod. width	Order details		Price	Weight	Pack
		Type code	Order code	1 piece	1 piece	unit
white	–	2CSKK1202C	2CSK232205R1202	€	kg	pc.
					0.07	1



2CSKK1504C

Set of 4 cover DND/MUR

Cover for Chiara KNX device 2CSKK1002C. With Do-Not-Disturb/Make-Up-Room symbols.

Description	Mod. width	Order details		Price	Weight	Pack
		Type code	Order code	1 piece	1 piece	unit
white	–	2CSKK1504C	2CSK232155R1504		kg	pc.
						1

ABB i-bus® KNX

User Operation – Design Ranges – Chiara



TR/U 1.1.CH

Transponder Reader, Chiara 2 modules

The “transponder reader” is a flush-mounting device, designed to realize access control systems with a communication support based on KNX bus. It is equipped with one relay (4 A @24 V AC/DC) and one input to be used for connecting external conventional card-holder (e.g. Chiara wiring accessories card-holder).

The output can be programmed in three different ways: “Linked to access control”, receiving in this case switching commands from the device itself (according to transponder card validation); being a standard KNX Switch actuator output, able to be controlled by every KNX-standard devices; “linked to card-holder”, that means that the relay is switched according to closing/opening internal input contact available on transponder reader.

The bicolor (red-green) LED placed on the front of the device allow you to monitor device operation and can be also switched ON/OFF in the proper color according to KNX telegram (for example for DND/MUR purposes).

The transponder reader requires a 12...24 V AC/DC external power supply to ensure its operation even with bus voltage failure.

The transponder reader is available for ABB Chiara wiring accessories range.

Description	Mod. width	Order details		Price	Weight	Pack
		Type code	Order code	1 piece	1 piece	unit
				kg	pc.	
	–	TR/U 1.1.CH	2CSK289601R1902			1



TH/U 1.1.CH

Transponder Holder, Chiara 2 modules

The “transponder holder” is a flush-mounting device for British Standard wall boxes, designed to realize access control systems with a communication support based on KNX bus. It is equipped with one relay (4 A @24 V AC/DC) and one binary input to be used for connecting external conventional push-button for switch, dimmer and shutter functionalities, or for example for connecting window contact or similar.

The output can be programmed as “Linked to access control”, receiving in this case switching commands from the device itself (according to card insertion/removal); or being a standard KNX Switch actuator output, able to be controlled by every KNX-standard devices.

The bicolor (red-green) LED placed on the front of the device allow you to monitor device operation and can be also switched ON/OFF in the proper color according to KNX.

The transponder reader requires a 12...24 V AC/DC external power supply to ensure its operation even with bus voltage failure.

The transponder reader is available for ABB Chiara wiring accessories range.

Description	Mod. width	Order details		Price	Weight	Pack
		Type code	Order code	1 piece	1 piece	unit
				kg	pc.	
	–	TH/U 1.1.CH	2CSK202481R1922			1



LT/U 1.1.CH

Transponder Reader, Chiara

The transponder reader is used for access control in the hotel, residential and commercial sectors (office buildings, business centers, laboratories, etc.). The device is equipped with two bistable relays (8 A, 250 V AC), one of which can be assigned to control electronic lock, and three voltage-free, non-optically insulated inputs; the 5-V DC scanning voltage is available on the COM terminal.

The transponder reader requires a 10...32 V DC/12...24 V AC external power supply to ensure its operation even with bus voltage failure.

Description	Mod. width	Order details		Price	Weight	Pack
		Type code	Order code	1 piece	1 piece	unit
				kg	pc.	
white	-	LT/U 1.1.CH	2CSKK5000C		0.05	1



PTI/U 1.1.CH

Transponder Holder, Chiara

The transponder holder is equipped with a slot into which the transponder card is inserted. In a hotel application, this allows occupancy recognition and notification at the supervisory level (e.g. on the front desk computer).

Moreover, room status information can be managed by using special cards (minibar status, maintenance status, usability).

The device is equipped with 2 bistable relays (8 A, 250 V AC) and 3 voltage-free, non-optically insulated inputs; the 5-V DC scanning voltage is available on the COM terminal.

The transponder pocket requires a 10...32 V DC/12...24 V AC external power supply to ensure its operation even with bus voltage failure.

Description	Mod. width	Order details		Price	Weight	Pack
		Type code	Order code	€	kg	pc.
white	-	PTI/U 1.1.CH	2CSKK5200C		0.05	1



PRT/U 1.1.CH

Transponder Programming Device, Chiara

The devices allows the programming of transponder cards.

The device is equipped with 2 bistable relays (8 A, 250 V AC) and 3 voltage-free non-optically insulated inputs; 5 V DC scanning voltage is available on the COM terminal.

The transponder programmer requires a 10...32 V DC/12...24 V AC external power supply to ensure its operation even with bus voltage failure.

Description	Mod. width	Order details		Price	Weight	Pack
		Type code	Order code	€	kg	pc.
white	-	PRT/U 1.1.CH	2CSKK5300C		0.05	1

ABB i-bus® KNX

User Operation – Design Ranges – Chiara

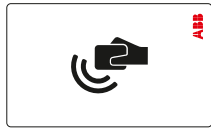

CH/T 2
CH/T 2.1

Set of 5 Transponder Cards for Chiara and Mylos design programs

The transponder card uses passive transponder technology operating in radio frequency, without the need for contact between the reader and the card itself. The transponder card is read by swiping it in front of the reader at a maximum distance of 20 mm.

Description	Mod. width	Order details		Price	Weight	Pack
		Type code	Order code	1 piece	1 piece	unit
				€	kg	pc.
5 transponder cards	–	CH/T 2	2CSKK5400C		0.005	1
1000 transponder cards	–	CH/T 2.1	2CSY289611R1941		1	1



TS/T 1
TS/T 1.1

Set of Transponder Cards for Millenium,

Chiara 2 modules and tacteo design programs

The transponder card uses passive transponder technology operating in radio frequency (MIFARE technology), without the need for contact between the reader and the card itself. The transponder card is read by swiping it in front of the reader at a maximum distance of 20 mm (can be reduced according to installation environment).

Description	Mod. width	Order details		Price	Weight	Pack
		Type code	Order code	€	kg	pc.
10 transponder cards	–	TS/T 1	2CSY259412R2041		0.02	1
1000 transponder cards	–	TS/T 1.1	2CSY232175R2041		1	1



SW MiniMAC 4.1

MiniMAC software

The management and configuration software ensures bidirectional communication with the access control system devices, allowing the system's configuration during its installation and its overall management and supervision.

Description	Mod. width	Order details		Price	Weight	Pack
		Type code	Order code	€	kg	pc.
	–	SW MiniMAC 4.1	2CSY258202R2051		0.005	1



RoomGuard software

RoomGuard software**NEW**

RoomGuard software for configuration and supervision of ABB Access Control range; Tacteo, Millenium, Zenit, Chiara, and Mylos.

RoomGuard is a web-based scalable solution (licensing model based on number of rooms) accessible by any browser providing greater accessibility for hotel and maintenance staff. Main features and functionality include: Access control (management of keys, groups, time bands and staff cards, definition of access to common areas, and more), room state monitoring, guest check in/check out, front desk room load monitoring, management of guest and employee databases, Occupancy and access records and statistics, front desk management of room climate, and maintenance and diagnostics. RoomGuard features an intuitive and easy to use interface, with straightforward installation and configuration, seamless integration with building automation and third-party software integration.

RoomGuard software replaces MiniMAC software.

Available June 2023

Description	Mod. width	Order details		Price	Weight	Pack
		Type code	Order code	1 piece	1 piece	unit
				€	kg	pc.
RoomGuard software, 10 readers/rooms	-	RoomGuard-10	2CSY247450R0010	-	-	1
RoomGuard software, 20 readers/rooms	-	RoomGuard-20	2CSY244490R0020	-	-	1
RoomGuard software, 50 readers/rooms	-	RoomGuard-50	2CSY249580R0050	-	-	1
RoomGuard software, 100 readers/rooms	-	RoomGuard-100	2CSY242150R0100	-	-	1
RoomGuard software, 200 readers/rooms	-	RoomGuard-200	2CSY247240R0200	-	-	1
RoomGuard software, PMS interface	-	RoomGuard-PMS	2CSY244280R0999	-	-	1

