

Electrical installation solutions for buildings – Technical details

MCBs

Index

Definitions according to standards for miniature circuit breakers	1/2
Tripping characteristics	1/4
Limitation of specific let-through energy I^2t	1/16
Peak current I_p	1/35
SOC - Selected Optimized Coordination	1/46
Coordination tables: back-up	1/47
Coordination tables: selectivity	1/82
MCBs internal resistance, power loss and max. permissible earth-fault loop impedance	1/149
Performances at different ambient temperatures, altitudes and frequencies	1/156
Use of MCBs in direct current circuits	1/165
S 200 UDC series DC Applications	1/166
S 200 MUC series AC/DC Applications	1/168
S800 series DC applications	1/169
Use of MCBs in altitude and different network frequency	1/172
Instruction for use of S 200 S	1/173
Particular supply sources and loads	1/174
S800 range features	1/179
S800-SCL-SR range features	1/182

MCBs technical details

Definitions according to standards for miniature circuit breakers

Rated insulation voltage (U_i) according IEC/EN 60664-1:

Root mean square (R.M.S.) withstand voltage value assigned by the manufacturer to the equipment or to a part of it, characterizing the specified (long-term) withstand capability of its insulation.

NOTE:

The rated insulation voltage is not necessarily equal to the rated voltage of the equipment which is primarily related to functional performance.

IEC/EN 60898-1

Miniature Circuit Breakers according IEC/EN 60898-1 are intended for the protection against overcurrents of wiring installations of buildings and similar applications; they are designed for use by uninstructed people and for not being maintained. This part of IEC/EN 60898 applies for a.c. air-break circuit-breakers for operation at 50 Hz or 60 Hz, having a rated voltage not exceeding 440 V (between phases), a rated current not exceeding 125 A and a rated short-circuit capacity not exceeding 25.000 A. As far as possible, it is in line with the requirements contained in IEC/EN 60947-2.

Rated short-circuit capacity (I_{cn})

The rated short-circuit capacity of a circuit-breaker is the value of the ultimate short-circuit breaking capacity assigned to that circuit-breaker by the manufacturer. The sequence of operations shall be: O – t – CO.*

Service short-circuit capacity (I_{cs})

A circuit-breaker having a given rated short-circuit capacity has a corresponding fixed service short-circuit capacity (I_{cs}). This is therefore generally not indicated.

Rated operational voltage (U_n)

The rated voltage of a circuit-breaker is the value of voltage, assigned by the manufacturer, to which its performance (particularly the short-circuit performance) is referred. The same circuit-breaker may be assigned a number of rated voltages and associated rated short-circuit capacities.

2The voltage which appears across the terminals of a pole of a circuit-breaker after the breaking of the current.

The value of the power frequency recovery voltage shall be equal to 110% of the rated voltage of the circuit-breaker under test.

IEC/EN 60947-2

This part of the IEC/EN 60947 applies to circuit-breakers, the main contacts of which are intended to be connected to circuits, the rated voltage of which does not exceed 1.000 V a.c. or 1.500 V d.c..

It applies whatever the rated currents, the method of construction or the proposed applications of the circuit-breakers may be.

The circuit-breakers are designed for use by instructed people.

Rated ultimate short-circuit breaking capacity I_{cu}

The rated ultimate short-circuit breaking capacity of a circuit-breaker is the value of ultimate short-circuit breaking capacity assigned to that circuit-breaker by the manufacturer for the corresponding rated operational voltage. It is expressed as the value of the prospective breaking current, in kA (r.m.s. value of the a.c. component in the case of a.c.).

The sequence of operations shall be: O – t – CO.*

Rated service short-circuit breaking capacity I_{cs}

The rated service short-circuit breaking capacity of a circuit-breaker is the value of service short-circuit breaking capacity assigned to that circuit-breaker by the manufacturer for the corresponding rated operational voltage. It is expressed as a value of prospective breaking current, in kA, corresponding to one of the specified percentages of the rated ultimate short-circuit breaking capacity and rounded up to the nearest whole number. It may be expressed as a % of I_{cu} (for example I_{cs} = 25% I_{cu}).

The sequence of operations shall be: O – t – CO – t – CO.*

* The following symbols are used for defining the sequence of operations:

O represents an opening operation.

CO represents a closing operation followed by an automatic opening.

t represents the time interval between two short-circuit operations.

MCBs technical details

Definitions according to standards for miniature circuit breakers

Rated operational voltage (U_e)

The rated operational voltage of an equipment is a value of voltage which, combined with a rated operational current, determines the application of the equipment and to which the relevant tests and the utilization categories are referred. For single-pole equipment it is generally stated as the voltage across the pole. For multi pole equipment it is generally stated as the voltage between phases.

An equipment may be assigned a number of combinations of rated operational voltage and associated making and breaking capacities for different duties and utilization categories.

Max. power frequency recovery voltage (U_{max})

Voltage which appears across the terminals of a pole of a switching device after the breaking of the current.

For all breaking capacities and short-circuit breaking capacity tests, the value of the power-frequency recovery voltage shall be 105% of the value of the rated operational voltage. This value shall be within the specified tolerance (voltage 0 / + 5%).

NOTE:

The value of 1.05 times the rated operational voltage for the power frequency recovery voltage, together with the test voltage tolerance resulting in a maximum voltage of 1.1 times the rated operational voltage, is deemed to cover the effects of variations of the system voltage under normal service conditions.

UL 489

The requirements of this standard cover molded-case circuit breakers, circuit breaker and ground-fault circuit-interrupters, fused circuit breakers, and accessory high-fault protectors. These circuit breakers are specifically intended to provide service entrance, feeder, and branch circuit protection in accordance with the National Installation Codes in Annex B, Ref. No.1.

This standard also covers instantaneous-trip circuit breakers (circuit interrupters) specifically intended for use as part of a combination motor controller in accordance with the National Installation Codes in Annex B, Ref. No. 1.

UL489B

These requirements cover molded-case circuit breakers, molded-case switches, and circuit-breaker enclosures rated up to 1000 V dc, intended for use with photovoltaic (PV) systems and Article 690 of the National Electrical Code, ANSI/NFPA-70. These requirements are intended to be used in conjunction with the requirements in the Standard for Molded-Case Circuit Breakers, Molded-Case Switches and Circuit-Breaker Enclosures, UL 489.

UL 1077

These requirements apply to supplementary protectors intended for use as overcurrent, or over- or under-voltage protection within an appliance or other electrical equipment where branch circuit overcurrent protection is already provided, or is not required.

Compliance with this standard is acceptable for use as a component of an end product.

MCBs technical details

Tripping characteristics

Tripping characteristics S 200 / S 200 M / S 200 P / S 200 S / S 200 MUC / SN 201 L / SN 201 / SN 201 M / S200C

Acc. to	Tripping characteristic and rated current	Thermal release ②			Electromagnetic release ①		Tripping time
		Current: conventional non-tripping current	conventional tripping current	Tripping time	Currents: hold current surges	trip at least at	
IEC/EN 60898-1	B	6 to 63 A	$1.13 \cdot I_n$	> 1 h	$3 \cdot I_n$	> 0.1 s	
				$1.45 \cdot I_n$	< 1 h	$5 \cdot I_n$	< 0.1 s
	C	0.5 to 63 A	$1.13 \cdot I_n$	> 1 h	$5 \cdot I_n$	> 0.1 s	
				$1.45 \cdot I_n$	< 1 h	$10 \cdot I_n$	< 0.1 s
	D	0.5 to 63 A	$1.13 \cdot I_n$	> 1 h	$10 \cdot I_n$	> 0.1 s	
				$1.45 \cdot I_n$	< 1 h	$20 \cdot I_n$	< 0.1 s
IEC/EN 60947-2	K	0.2 to 63 A	$1.05 \cdot I_n$	> 1 h	$10 \cdot I_n$	> 0.2 s	
				$1.2 \cdot I_n$	< 1 h ③	$14 \cdot I_n$	< 0.2 s
				$1.5 \cdot I_n$	< 2 min. ③		
				$6.0 \cdot I_n$	> 2 s (T1)		
	Z	0.5 to 63 A	$1.05 \cdot I_n$	> 1 h	$2 \cdot I_n$	> 0.2 s	
				$1.2 \cdot I_n$	< 1 h ③	$3 \cdot I_n$	< 0.2 s

① The indicated electromagnetic tripping values apply to a frequency range of 16 2/3 ... 60 Hz. For different network frequencies or direct current the values change according to the multiplier in the table below

② The thermal releases are calibrated to a nominal reference ambient temperature; for Z and K, the value is 20 °C, for B and C = 30 °C.

In the case of higher ambient temperatures, the current values fall by ca. 6% for each 10 K temperature rise.

③ As from operating temperature (after $I_1 > 1$ h or, as applicable, 2 h).

Tripping characteristics S300P

Acc. to	Tripping characteristics	Rated current	Thermal release ②			Electromagnetic release ①		Tripping time
			Currents: conventional non-tripping current	conventional tripping current	Tripping time	Currents: hold current surges	trip at least at	
IEC/EN 60898-1	B	06 to 63 A	$1.13 \cdot I_n$	> 1 h	$3 \cdot I_n$	> 0.1 s		
				$1.45 \cdot I_n$	< 1 h	$5 \cdot I_n$	< 0.1 s	
	C	0.5 to 63 A	$1.13 \cdot I_n$	> 1 h	$5 \cdot I_n$	> 0.1 s		
				$1.45 \cdot I_n$	< 1 h	$10 \cdot I_n$	< 0.1 s	
	D	0.5 to 63 A	$1.13 \cdot I_n$	> 1 h	$10 \cdot I_n$	> 0.1 s		
				$1.45 \cdot I_n$	< 1 h	$20 \cdot I_n$	< 0.1 s	
IEC/EN 60947-2	K	0.2 to 63 A	$1.05 \cdot I_n$	> 1 h	$10 \cdot I_n$	> 0.2 s		
				$1.3 \cdot I_n$	< 1 h ③	$14 \cdot I_n$	< 0.2 s	
	Z	0.5 to 63 A	$1.05 \cdot I_n$	> 1 h	$2 \cdot I_n$	> 0.2 s		
				$1.3 \cdot I_n$	< 1 h ③	$3 \cdot I_n$	< 0.2 s	

① The indicated electromagnetic tripping values apply to a frequency range of 16 2/3... 60 Hz. For different network frequencies or direct current the values change according to the multiplier in the table below

② The thermal releases are calibrated to a nominal reference ambient temperature; for Z and K, the value is 40°C, for B, C and D is 30°C. In the case of higher ambient temperatures, the current values fall by ca. 6% for each 10 K temperature rise.

③ As from operating temperature (after $I_1 > 1$ h or, as applicable, 2 h).

MCBs technical details

Tripping characteristics

Tripping characteristics S 200 / S 200 M / S 200 P / S 200 S / S 200 MUC / SN 201 L / SN 201 / SN 201 M

	AC			DC
	100 Hz	200 Hz	400 Hz	
Multiplier	1.1	1.2	1.5	1.5

The thermal tripping performance is independent from the network frequency

Tripping characteristics SU200 M

Acc. to	Tripping characteristics	Rated current	Thermal release ¹⁾		Tripping time	Electromagnetic release ²⁾	
			Currents:			Range of instantaneous tripping	Tripping time
			conventional non-tripping current	conventional tripping current			
I_n	I1	I2					
UL 489	C	0.5 to 63 A	$1.03 \cdot I_n$		> 1 h	$5 \cdot I_n$	> 0.2 s
					$1.25 \cdot I_n$		
	K	0.2 to 63 A	$1.03 \cdot I_n$		> 1 h	$10 \cdot I_n$	> 0.2 s
					$1.25 \cdot I_n$		
	Z	0.5 to 63 A	$1.03 \cdot I_n$		> 1 h	$2 \cdot I_n$	> 0.2 s
					$1.25 \cdot I_n$		

¹⁾ The thermal releases are calibrated to a nominal reference ambient temperature e.g. for UL 489 of 40°C.

In the case of higher ambient temperatures, the current values fall by approx. 4 % for each 10 K temperature rise.

²⁾ The indicated tripping values of electromagnetic tripping devices apply to a frequency of 50/60 Hz. The thermal release operates independent of frequency.

³⁾ As from operating temperature (after I1 > 1h)

Tripping characteristics S200 80-100A

Acc. to	Tripping characteristics	Rated current	Thermal release ¹⁾		Tripping time	Electromagnetic release ²⁾	
			Currents:			Range of instantaneous tripping	Tripping time
			conventional non-tripping current	conventional tripping current			
I_n	I1	I2					
IEC/EN 60898-1	B	80 up to 100 A	$1.13 \cdot I_n$		> 2 h	$3 \cdot I_n$	0.1 ... 90 s
					$1.45 \cdot I_n$		
	C	80 up to 100 A	$1.13 \cdot I_n$		> 2 h	$5 \cdot I_n$	0.1 ... 30 s
					$1.45 \cdot I_n$		

¹⁾ The thermal releases are calibrated to a nominal reference ambient temperature; for B and C the reference value is 30 °C.

In the case of higher ambient temperatures, the current values fall by approx. 6 % for each 10 K temperature rise.

²⁾ The indicated tripping values of electromagnetic tripping devices apply to a frequency of 50/60 Hz. The thermal release operates independent of frequency.

Tripping characteristics S 750 DR

Tripping characteristic	Reference ambient temperature	Delayed overload tripping			Short-time delayed selective tripping		
		Conventional non-tripping current	Conventional tripping current	Tripping time	Delayed tripping current	Short-time delayed tripping current	Tripping time
		I_{nt}	I_t	t	I_{tv}	I_{tk}	t
$E_{selective}$	30 °C	$1.05 \times I_n$		≥ 2 h	$5 \times I_n$		$0.05 \text{ s} < t < 5 \text{ s} (I_n \leq 32 \text{ A})$
			$1.2 \times I_n$	< 2 h			$0.05 \text{ s} < t < 10 \text{ s} (I_n > 32 \text{ A})$
$K_{selective}$	30 °C	$1.05 \times I_n$		≥ 2 h	$8 \times I_n$		$0.01 \text{ s} < t < 0.3 \text{ s}$
			$1.2 \times I_n$	< 2 h			$0.01 \text{ s} < t < 0.3 \text{ s}$

¹⁾ Reference ambient temperature 30 °C (in the case of higher ambient temperatures, the current values are reduced by ca. 5 % per each 10 K)

MCBs technical details

Tripping characteristics

Tripping characteristic S800

Acc. to	Tripping characteristic and rated current	Thermal release ②			Electromagnetic release ①		
		Current	Tripping time	Current	Tripping time	Current	Tripping time
		conventional non-tripping current	conventional tripping current		hold current surges	trip at least at	
IEC/EN 60898-1	B	10 to 80 A	$1.13 \cdot I_n$	$> 1 \text{ h}$ ③	$3 \cdot I_n$		$> 0.1 \text{ s}$
				$1.45 \cdot I_n$	$< 1 \text{ h}$ ④	$5 \cdot I_n$	$< 0.1 \text{ s}$
	C	10 to 80 A	$1.13 \cdot I_n$	$> 1 \text{ h}$ ③	$5 \cdot I_n$		$> 0.1 \text{ s}$
					$1.45 \cdot I_n$	$< 1 \text{ h}$ ④	$10 \cdot I_n$
	D	10 to 80 A	$1.13 \cdot I_n$	$> 1 \text{ h}$ ③	$10 \cdot I_n$		$> 0.1 \text{ s}$
						$20 \cdot I_n$	$< 0.1 \text{ s}$
IEC/EN 60947-2	B	0.5 to 125 A	$1.05 \cdot I_n$	$> 1 \text{ h}$ ③	$3.2 \cdot I_n$		$> 0.1 \text{ s}$
						$4.8 \cdot I_n$	$< 0.1 \text{ s}$
	C	0.5 to 125 A	$1.05 \cdot I_n$	$> 1 \text{ h}$ ③	$6.4 \cdot I_n$		$> 0.1 \text{ s}$
						$9.6 \cdot I_n$	$< 0.1 \text{ s}$
	D	0.5 to 125 A	$1.05 \cdot I_n$	$> 1 \text{ h}$ ③	$10.4 \cdot I_n$		$> 0.1 \text{ s}$
						$15.6 \cdot I_n$	$< 0.1 \text{ s}$
	K	0.5 to 125 A	$1.05 \cdot I_n$	$> 1 \text{ h}$ ③	$10.4 \cdot I_n$		$> 0.1 \text{ s}$
						$15.6 \cdot I_n$	$< 0.1 \text{ s}$
	KM	20 to 80 A			$10.4 \cdot I_n$		$> 0.1 \text{ s}$
						$15.6 \cdot I_n$	$< 0.1 \text{ s}$
	UCB (DC only)	0.5 to 125 A	$1.05 \cdot I_n$	$> 1 \text{ h}$ ③	$4.8 \cdot I_n$		$> 0.1 \text{ s}$
						$7.2 \cdot I_n$	$< 0.1 \text{ s}$
	UCK (DC only)	0.5 to 125 A	$1.05 \cdot I_n$	$> 1 \text{ h}$ ③	$8.8 \cdot I_n$		$> 0.1 \text{ s}$
						$13.2 \cdot I_n$	$< 0.1 \text{ s}$
	PV-SP (DC only)	5 to 125 A	$1.05 \cdot I_n$	$> 1 \text{ h}$ ③	$4.8 \cdot I_n$		$> 0.1 \text{ s}$
						$6 \cdot I_n$	$< 0.1 \text{ s}$
UL489	Z	10 to 100 A	$1 \cdot I_n$	$> 1 \text{ h}$	$3.2 \cdot I_n$		$> 0.1 \text{ s}$
						$4.8 \cdot I_n$	$< 0.1 \text{ s}$
	K	10 to 100 A	$1 \cdot I_n$	$> 1 \text{ h}$	$10.4 \cdot I_n$		$> 0.1 \text{ s}$
						$15.6 \cdot I_n$	$< 0.1 \text{ s}$
	UCZ (DC only)	10 to 80 A	$1 \cdot I_n$	$> 1 \text{ h}$	$8.8 \cdot I_n$		$> 0.1 \text{ s}$
						$13.2 \cdot I_n$	$< 0.1 \text{ s}$
UL489B	PV-S (DC only)	5 A	$1.13 \cdot I_n$	$> 1 \text{ h}$	$4.8 \cdot I_n$		$> 0.1 \text{ s}$
			$1.3 \cdot I_n$	$< 1 \text{ h}$		$6 \cdot I_n$	$< 0.1 \text{ s}$

① The indicated electromagnetic tripping values apply to a frequency of 50/60 Hz.

② The thermal release are calibrated to a nominal reference ambient temperature; for B, C, D, UCB and PVS it is 30 °C, for K, UCK it is 20 °C for Z, K and UCZ it is 25 °C, for PVS acc. to UL489B it is 50 °C.

③ $t > 2 \text{ h}$ for $I_n > 63 \text{ A}$

④ $t < 2 \text{ h}$ for $I_n > 63 \text{ A}$

MCBs technical details

Tripping characteristics

Tripping characteristics S200 / S200M / S200P and for AC also SN201 / S200C

Characteristic B

IEC-EN60898

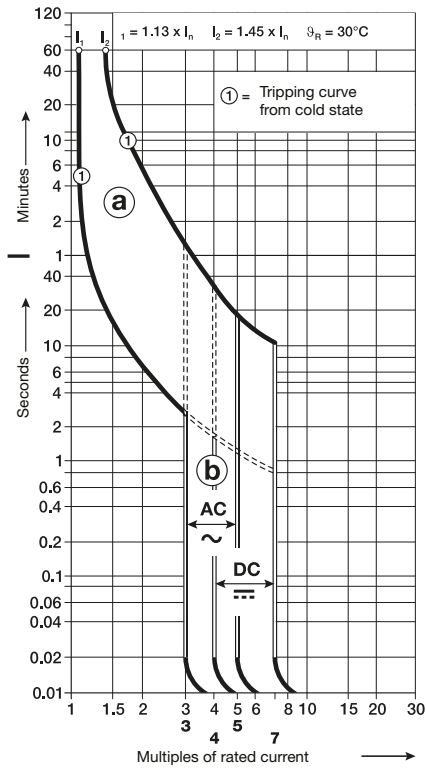

Characteristic C

IEC-EN60898

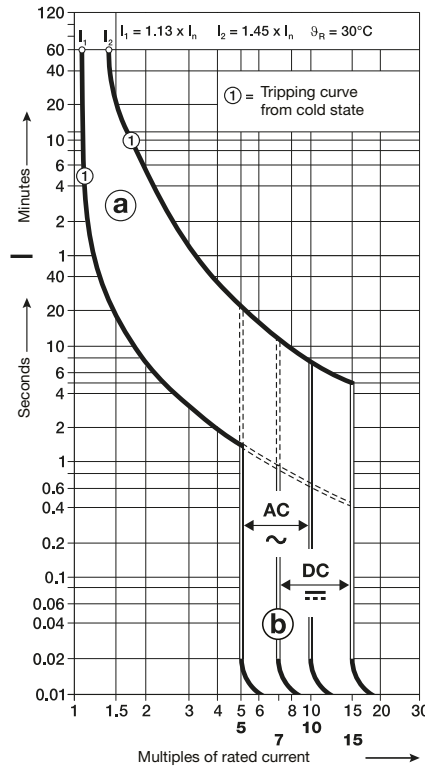

Characteristic D

IEC-EN60898

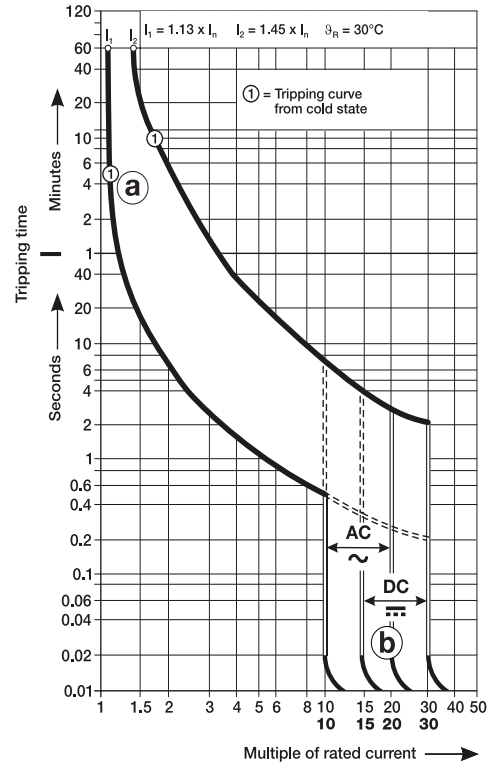

MCBs technical details

Tripping characteristics

Tripping characteristics S200 / S200M / S200P

Characteristic K

IEC-EN60947-2

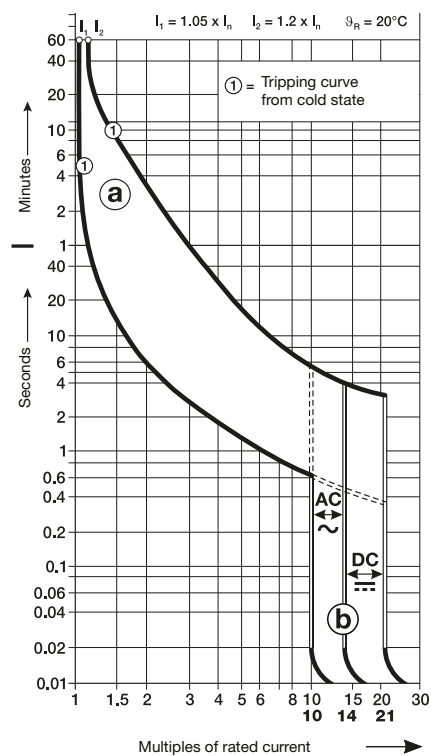

Characteristic Z

IEC-EN60947-2

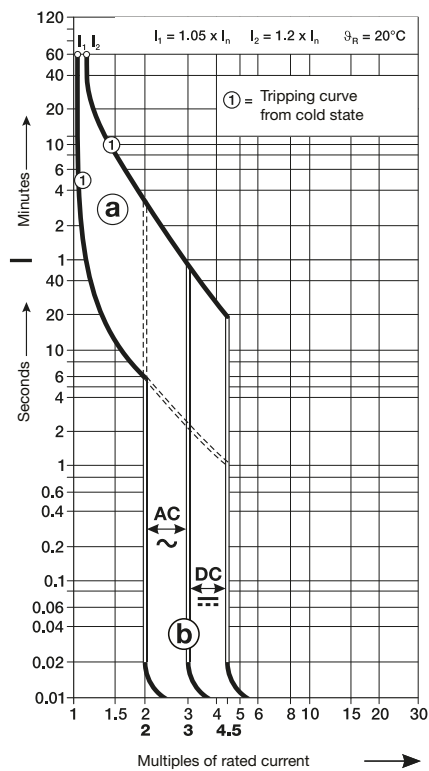

MCBs technical details

Tripping characteristics

Tripping characteristics S300P

MCB Type S300P - B (3 ... 5 x I_n AC)

Tripping Characteristic IEC/EN 60898-1

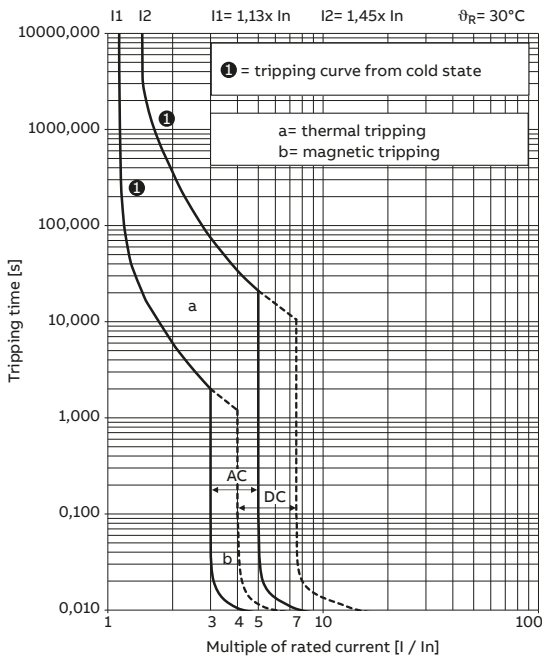

MCB Type S300P - C (5 ... 10 x I_n AC)

Tripping Characteristic IEC/EN 60898-1

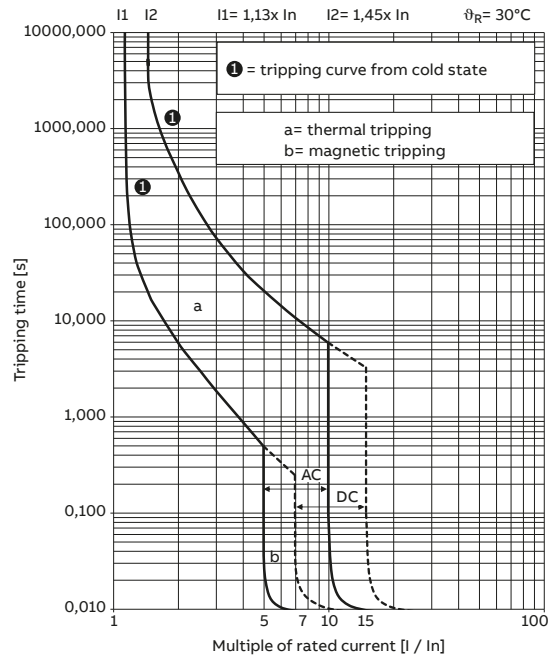

MCB Type S300P - D (10 ... 20 x I_n AC)

Tripping Characteristic IEC/EN 60898-1

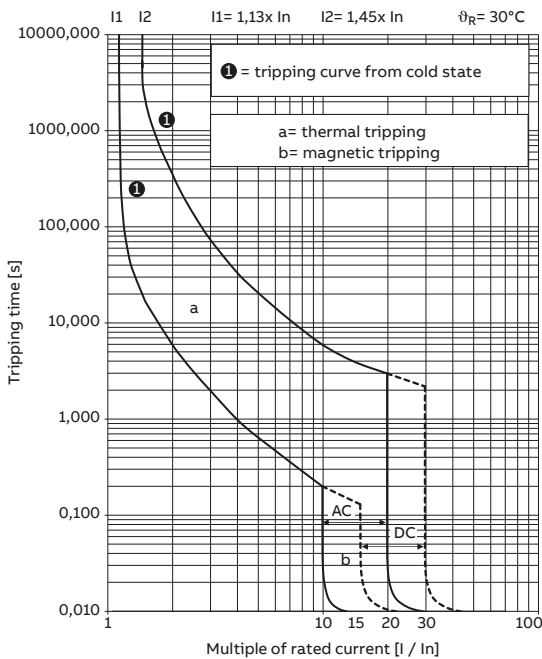

MCBs technical details

Tripping characteristics

Tripping characteristics S300P

MCB Type S300P - K (10 ... 14 x I_n AC)

Tripping Characteristic IEC/EN 60947-2

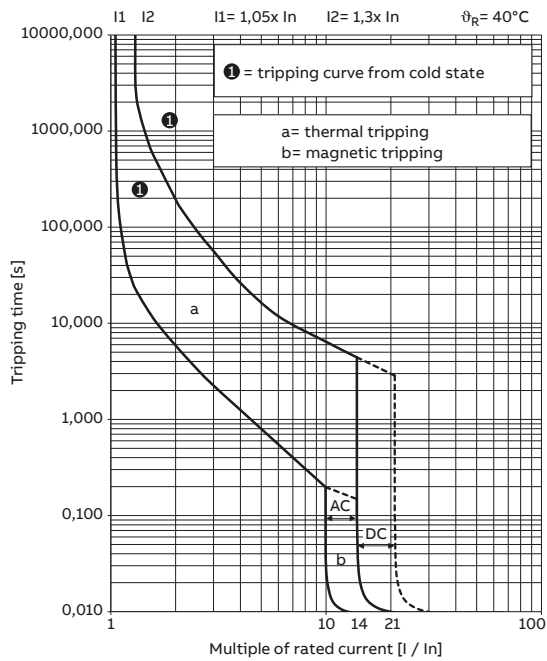

MCB Type S300P - Z (2 ... 3 x I_n AC)

Tripping Characteristic IEC/EN 60947-2

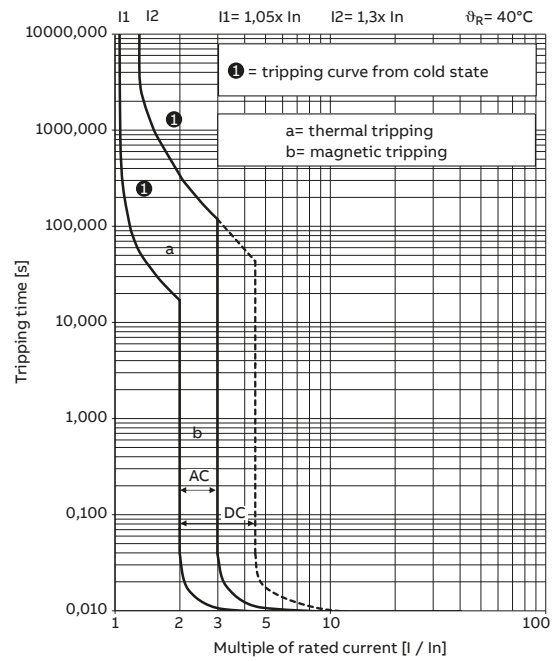

MCBs technical details

Tripping characteristics

Tripping characteristics S200S

Characteristic B

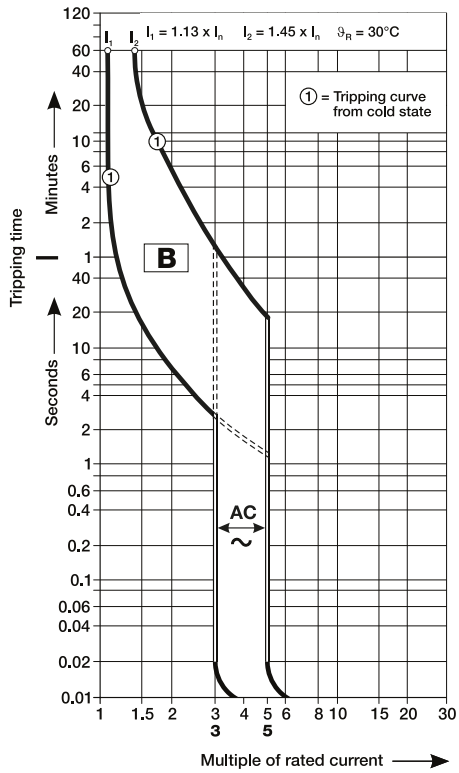

Characteristic C

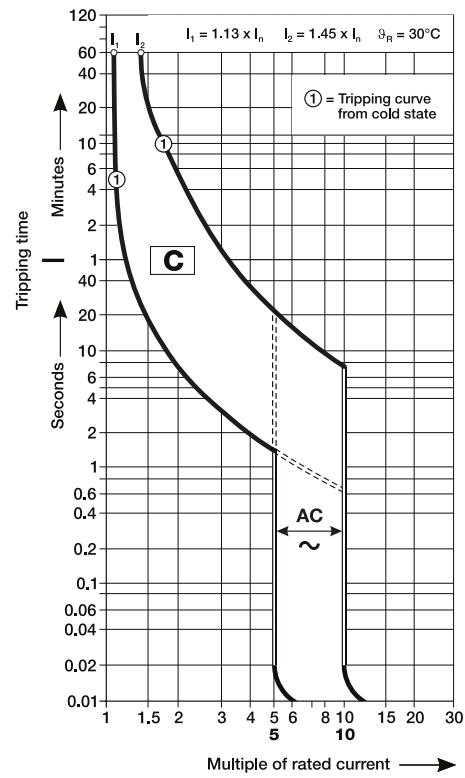

MCBs technical details

Tripping characteristics

Tripping characteristics SU200 M

Characteristic C

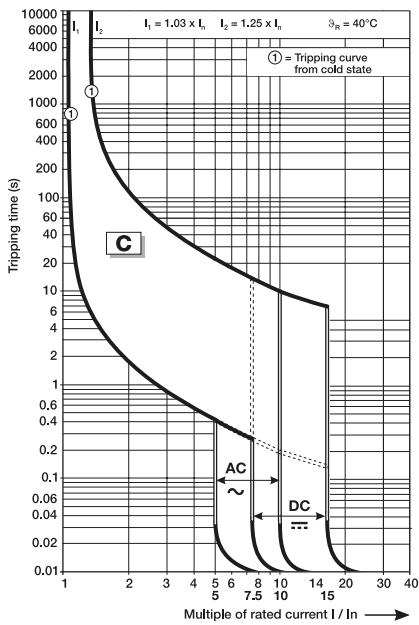

Characteristic K

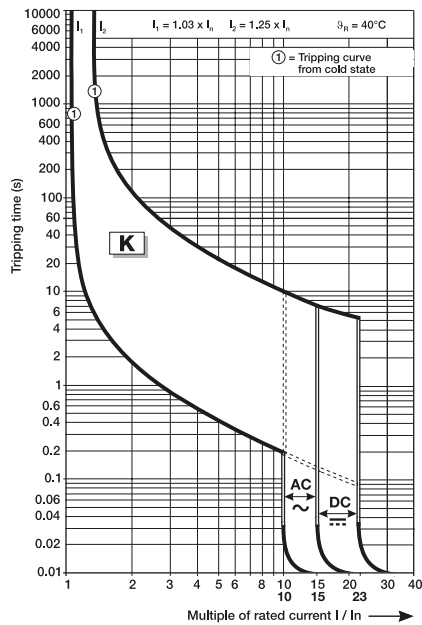

Characteristic Z

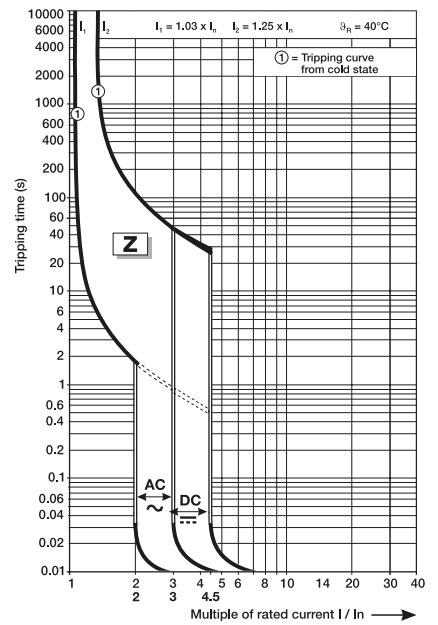

MCBs technical details

Tripping characteristics

Tripping characteristics S200 80-100A

Characteristic B
IEC-EN60898-1

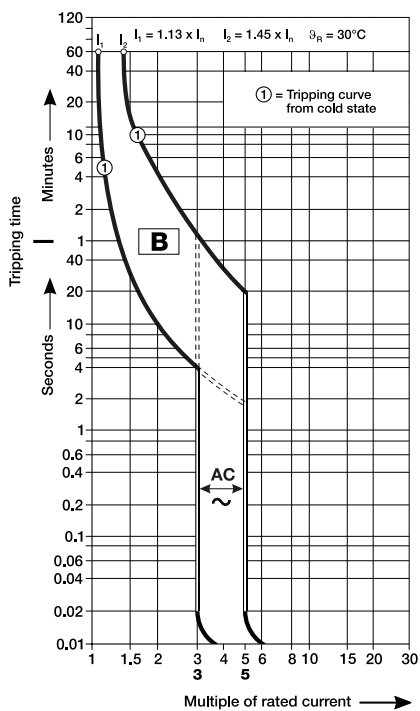

Characteristic B
IEC-EN60947-2

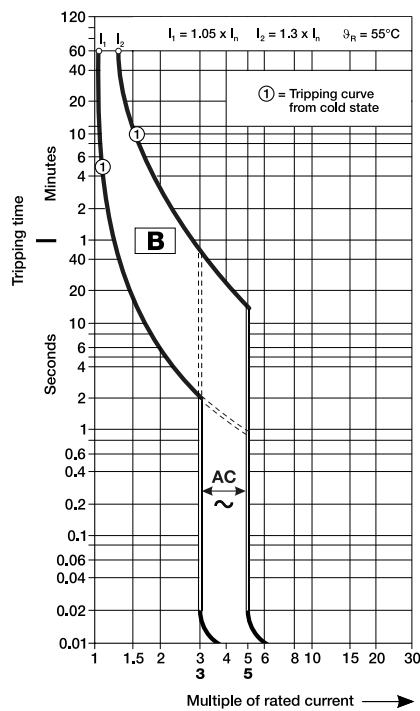

Characteristic C
IEC-EN60898-1

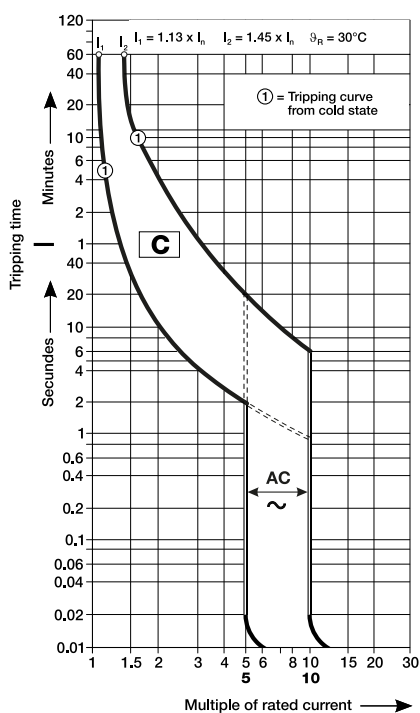

Characteristic C
IEC-EN60947-2

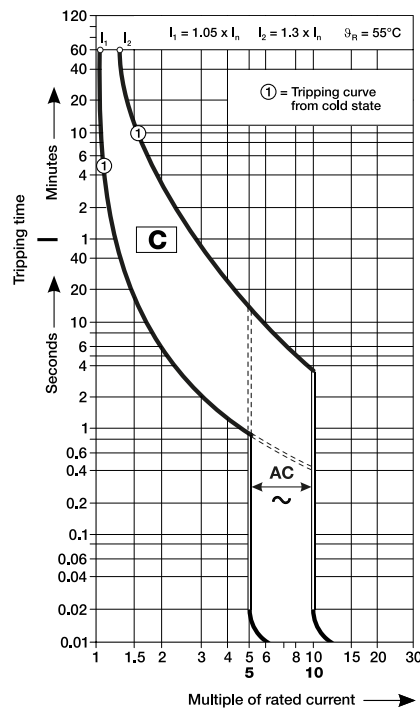

MCBs technical details

Tripping characteristics

Characteristic K

S 200 UDC

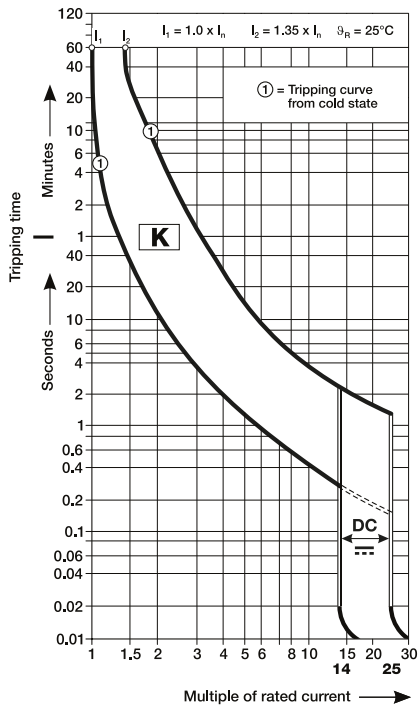

Characteristic Z

S 200 UDC

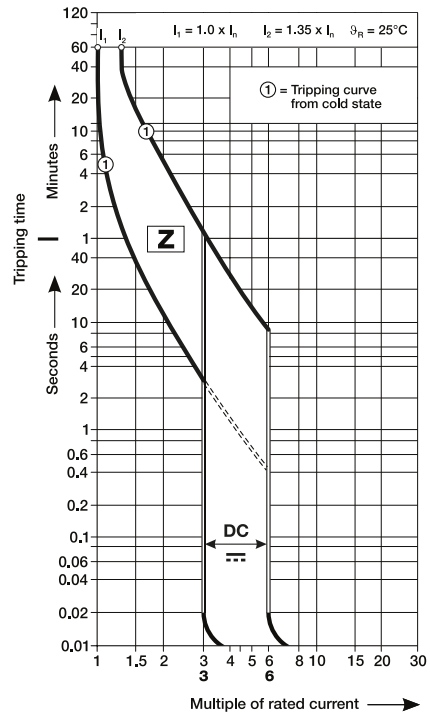

① thermal trip

② electromagnetic trip

MCBs technical details

Tripping characteristics

Characteristic $E_{selective}$, $K_{selective}$

S 750 DR - 16 ... 100 A

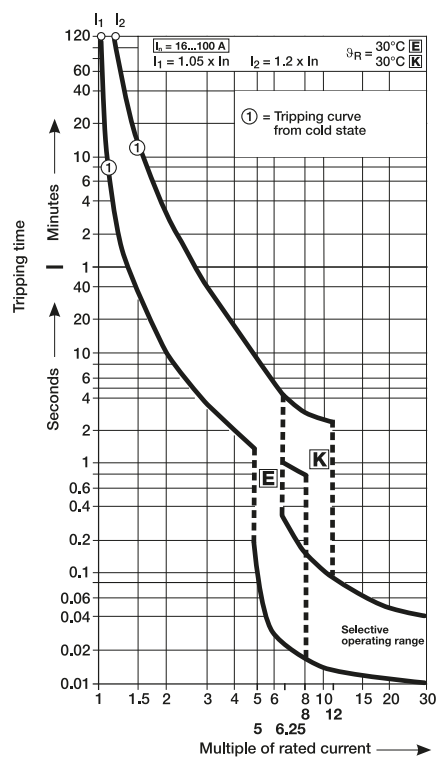

MCBs technical details

Tripping characteristics

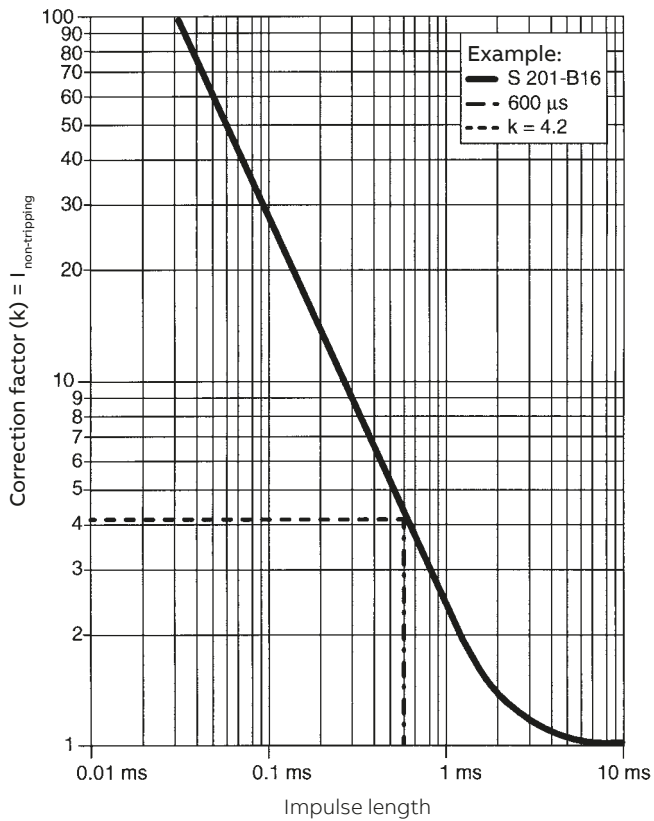

Example: Non-tripping current (Electromagnetic release)

S 201-B16

$$I_{\text{non-tripping}} = k \times \text{non-tripping current}$$

$$I_{\text{non-tripping}} = 4,2 \times 3 \times 16$$

$$I_{\text{non-tripping}} = 201,6 \text{ A}$$

B-Characteristic = $3 \times I_n$
 C-Characteristic = $5 \times I_n$
 D-Characteristic = $10 \times I_n$
 K-Characteristic = $10 \times I_n$
 Z-Characteristic = $2 \times I_n$

The S 201-B16 does not trip at an impulse of 600 es at a current up to 201,6 A.

MCBs technical details

Tripping characteristics

S800

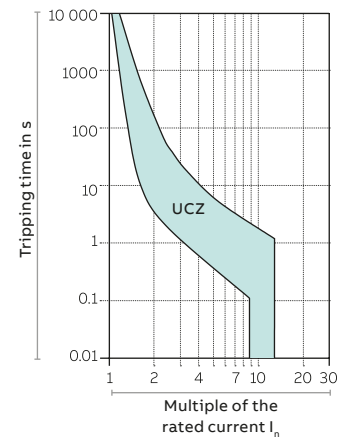
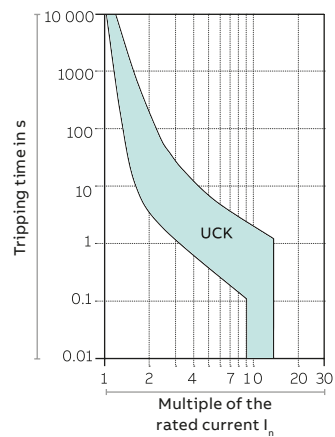
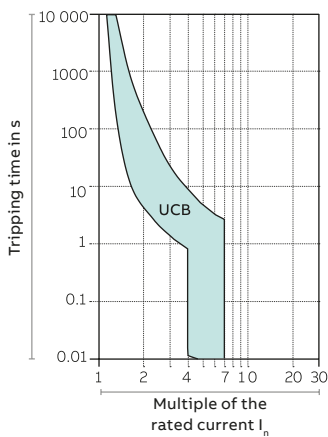
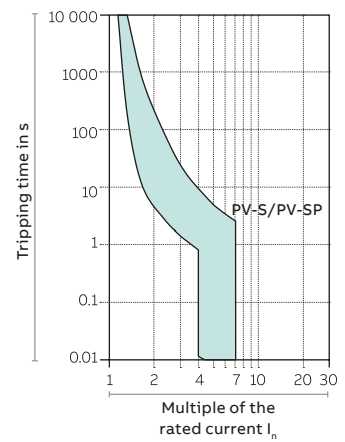
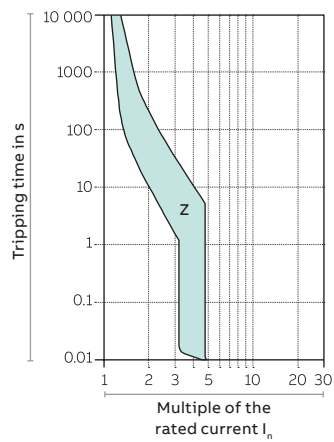
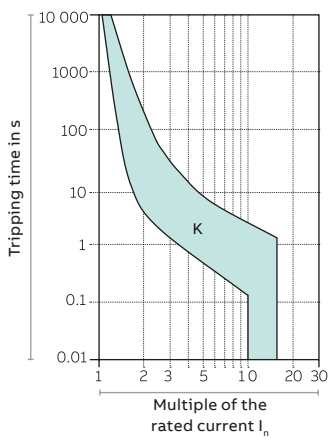
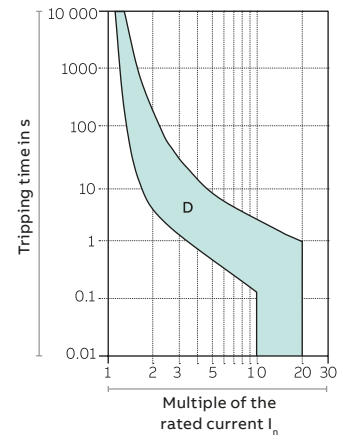
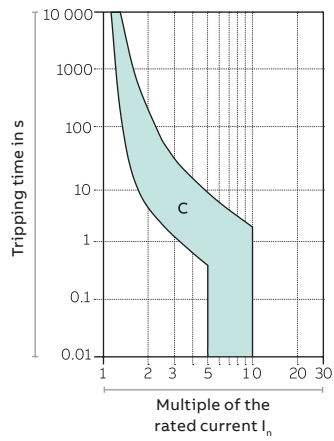
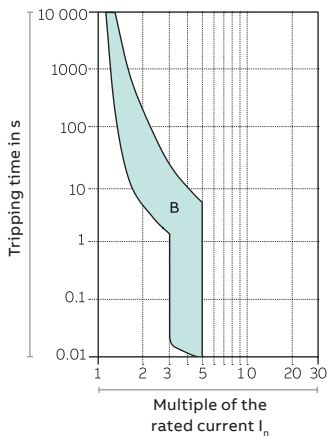

MCBs technical details

Limitation of specific let-through energy I^2t

Limitation of specific let-through energy

Tripping of an installation circuit by circuit-breaker when there is a short-circuit requires a certain amount of time depending on the characteristics of the circuit-breaker and the entity of the short-circuit current. During this period of time, some or all of the short-circuit current flows into the installation; the parameter I^2t defines the "specific let-through energy", ie. the specific energy that the breaker allows through when there is a short-circuit current I_{cc} during the tripping time t .

In this way, we can determine the capacity of a circuit-breaker to limit, ie. break high currents up to the rated breaking power of the device, by reducing the peak value of the above-mentioned currents to a value which is considerably lower than the estimated current.

This can be achieved using mechanisms which open very rapidly and have the following advantages:

- they limit the thermal and dynamic effects both on the circuit-breaker and on the protected circuit;
- they reduce the dimensions of the current-limiting circuit-breaker without reducing breaking capacity;
- they considerably reduce ionized gases and sparklers emitted during the short-circuit and therefore they avoid the danger of ignition and fires.

Irms = perspective simmetrical short-circuit current

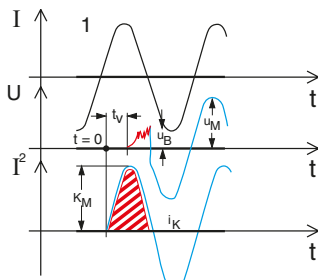

Non-current limiting circuit-breaker

Oscilloscope of short-circuit breaks on two circuit-breakers:

- 1 = traditional non-current limiting circuit-breaker
- 2 = current limiting circuit-breaker
- u_B = arc voltage (red)
- u_M = rest voltage (blue)

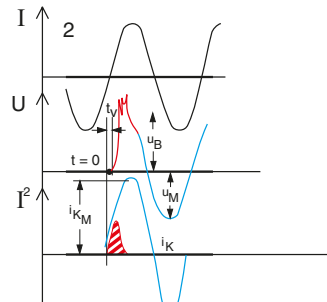

Current limiting circuit-breaker

Short-circuit current

- red = effective short-circuit current squared
- blue = estimated short-circuit current squared (shunted circuit-breaker)
- i_{K_M} = maximum values of symmetrical component of short-circuit current squared shaded in
- red = specific let-through energy in two cases

Limiting of let-through energy

Main selective circuit breakers (SMCB) like S 750 DR support downstream MCBs in clearing short-circuit currents. They additionally reduce let-through energies without tripping. This increases the operational availability of the electrical supply and reduces drawbacks to the feeding grid and the installed equipment.

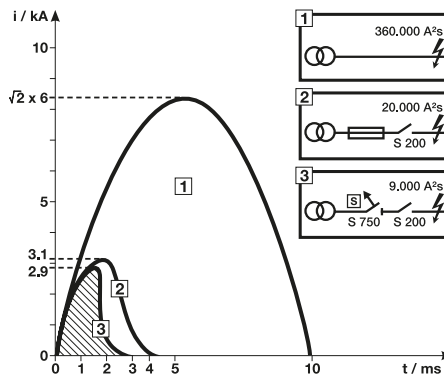

MCBs technical details

Limitation of specific let-through energy I^2t

Max. withstanding specific let-through energy of cables

Section mm ²	PVC	EPR	HEPR
50	33,062,500	39,062,500	51,122,500
35	16,200,625	19,140,625	25,050,025
25	8,265,625	9,765,625	12,780,625
16	3,385,600	4,000,000	5,234,944
10	1,322,500	1,562,500	2,044,900
6	476,100	562,500	736,164
4	211,600	250,000	327,184
2.5	82,656	97,656	127,806
1.5	29,756	35,156	46,010

The selection of the cables depends both from the breakers' specific let-through energy and from carrying capacity and voltage drop of the line.

Data of the previous table are referred to the following cables:

PVC	EPR	HEPR
FM9 FM9OZ1 N07V-K FROR	H07RN-F	N07G9-K FTG100M1 RG7OR FG7OM1 FG7OR

Designation

Cable's reference to the standards	harmonized	H
	national cable recognized by CENELC	A
Rated voltage U_o/U	$100/100 \leq U_o/U < 300/300$	01
	300/300 V	03
	300/500 V	05
	450/750 V	07
	750/1000 V	1
Insulating materials and non-metallic sheath	ethylene-vinylacetate	G
	mineral	M
	polyvinyl chloride	V
Conductor's shape	flexible conductor of a cable for fixed installation	K

Some cables on the market are identified with different names according with the designation UNEL 35011.

MCBs technical details

Limitation of specific let-through energy I^2t

I^2t diagrams - Specific let-through energy value I^2t

The I^2t curves give the values of the specific let-through

energy expressed in A^2s (A=amps; s=seconds) in relation to the perspective short-circuit current (I_{rms}) in kA.

S 200-S 200 M-S 200 P, characteristics B and C

230/400 V let-through energy

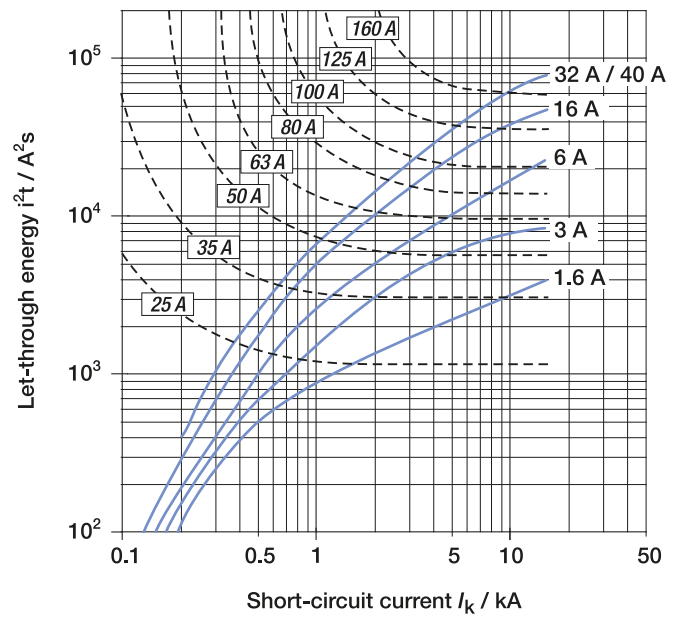
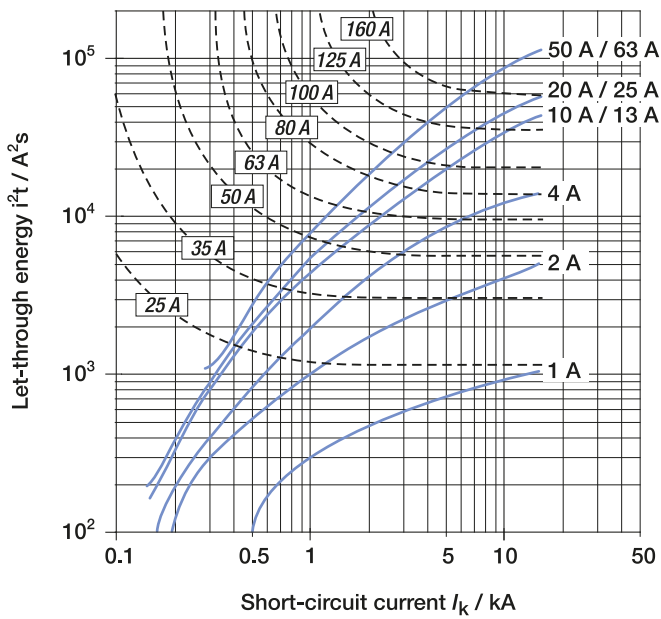

S 200-S 200 M-S 200 P, characteristics D-K

230/400 V let-through energy

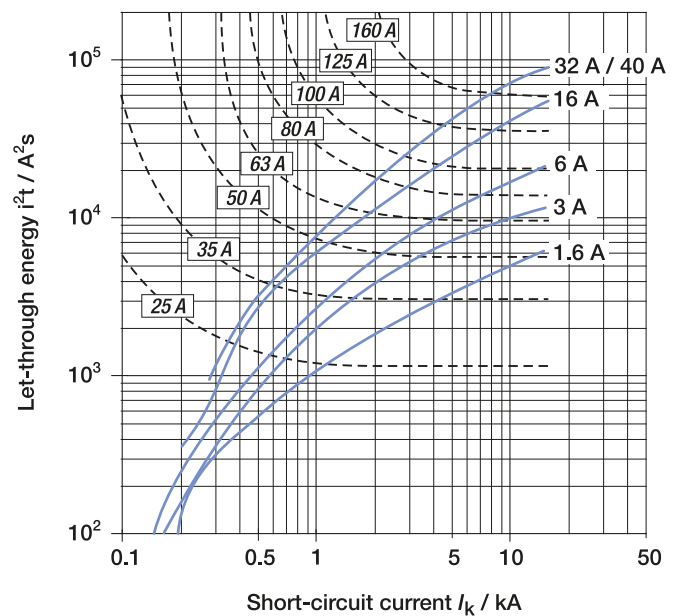
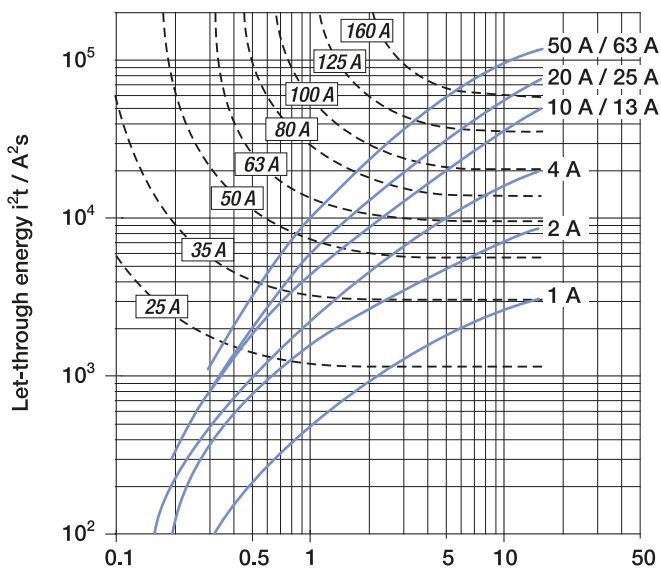

MCBs technical details

Limitation of specific let-through energy I^2t

S200MUC-B B-characteristic

1p: 220 V DC, 2 p: 440 V DC let-through energy

S200MUC-C C-characteristic

1p: 220 V DC, 2 p: 440 V DC let-through energy

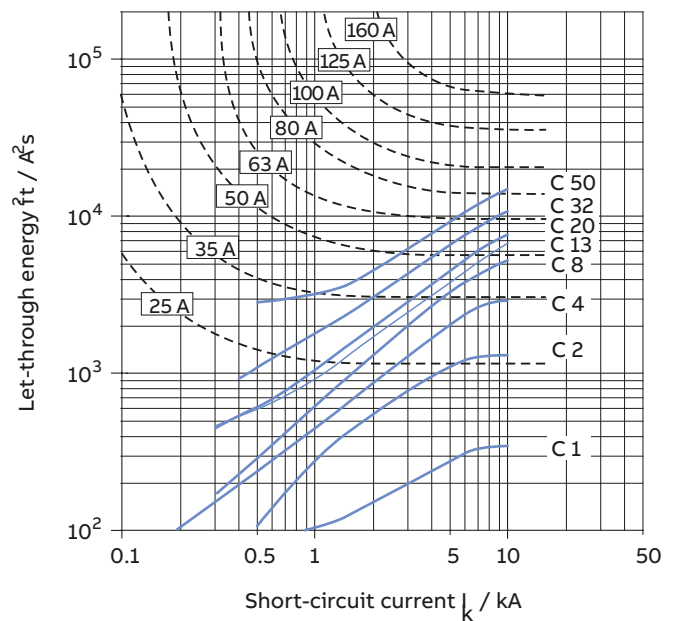
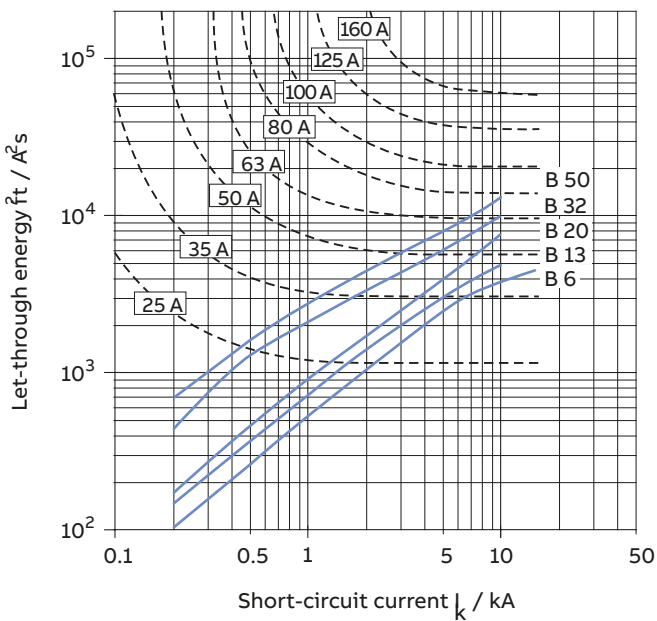
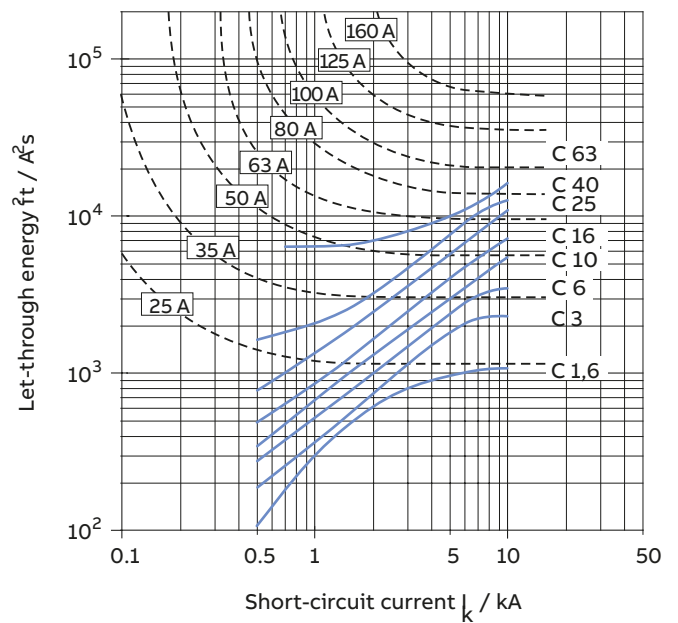
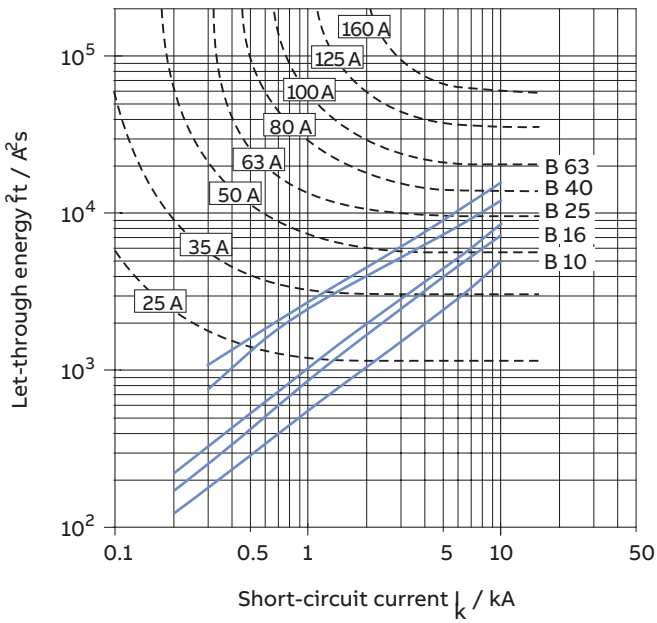

MCBs technical details

Limitation of specific let-through energy I^2t

S200MUC-K K-characteristic

1p: 220 V DC, 2 p: 440 V DC let-through energy

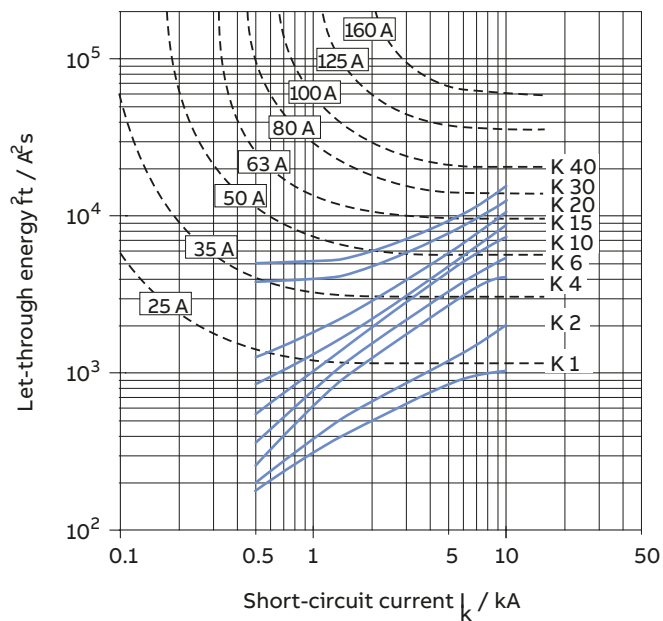
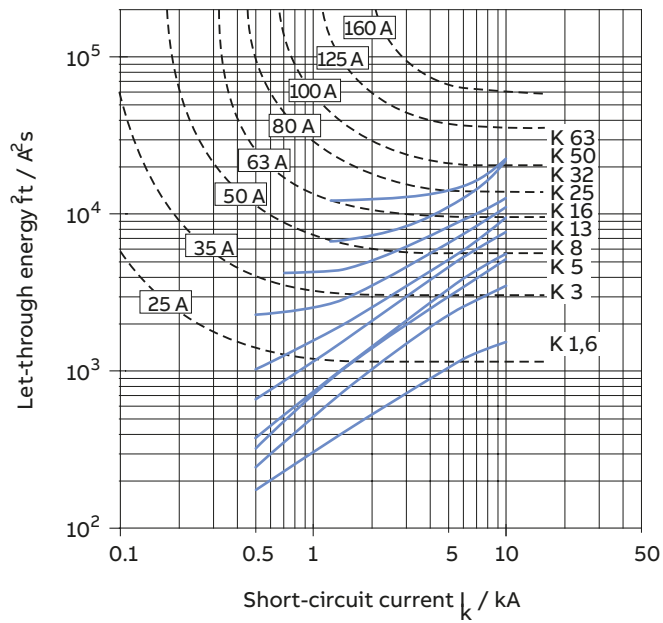

MCBs technical details

Limitation of specific let-through energy I^2t

S200MUC-Z Z-characteristic

1p: 220 V DC, 2 p: 440 V DC let-through energy

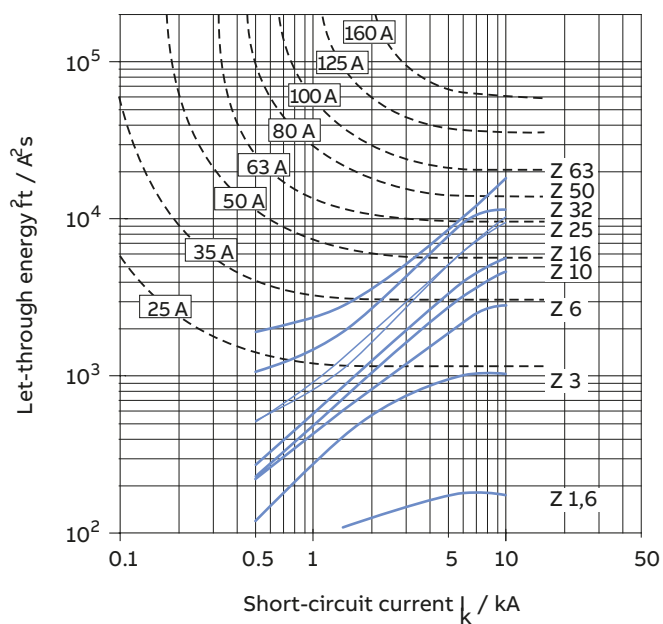
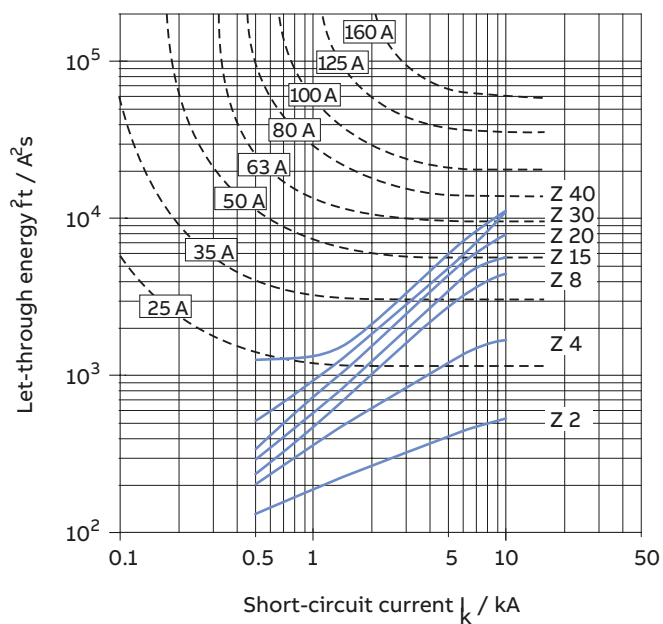

MCBs technical details

Limitation of specific let-through energy I^2t

S 200-S 200 M-S 200 P, characteristic Z

230/400 V let-through energy

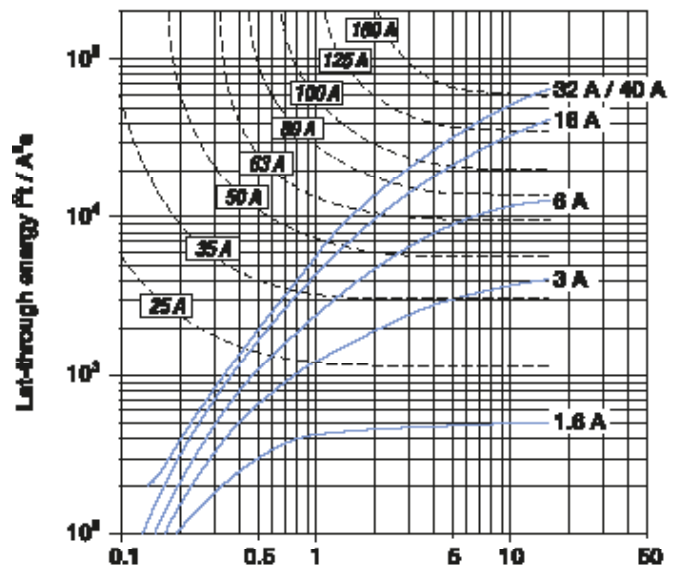
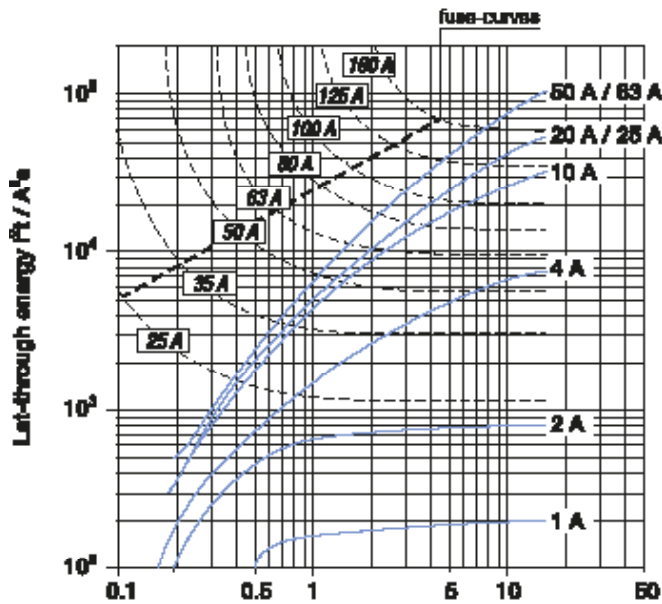

S 300 P, characteristic B, C

240/415 V let-through energy

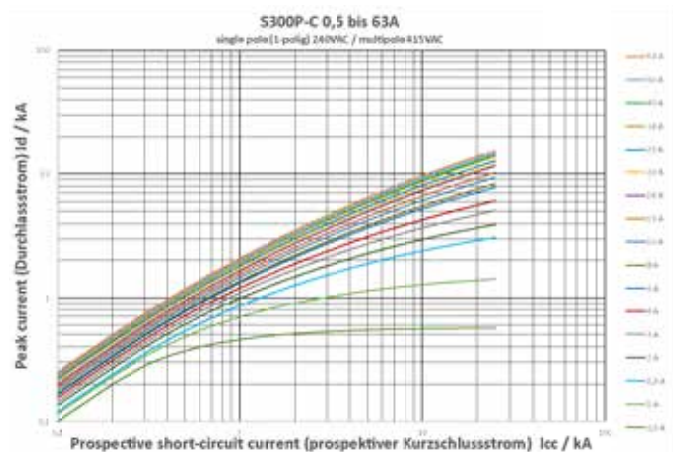
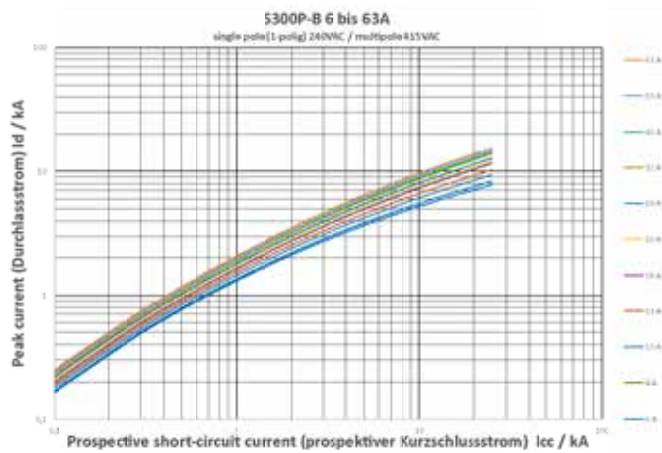

MCBs technical details

Limitation of specific let-through energy I^2t

S 300 P, characteristic D, K

240/415 V let-through energy

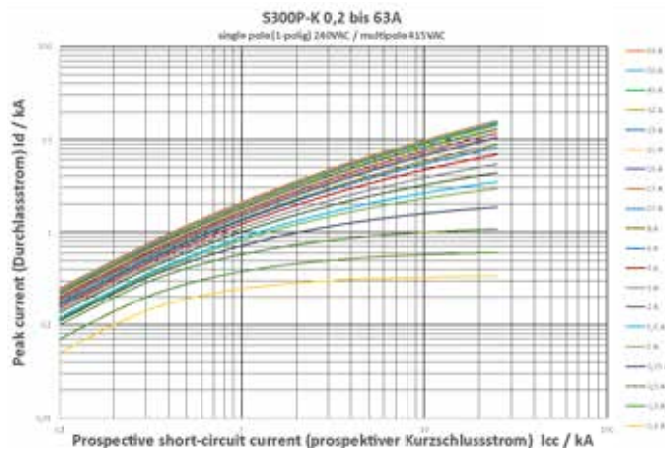
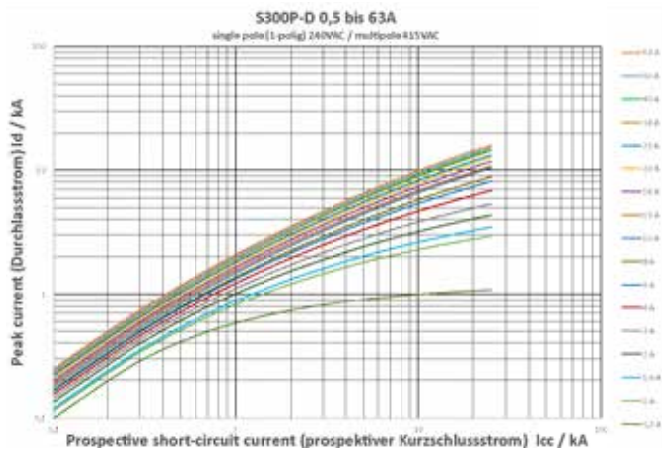

S 300 P, characteristic Z

240/415 V let-through energy

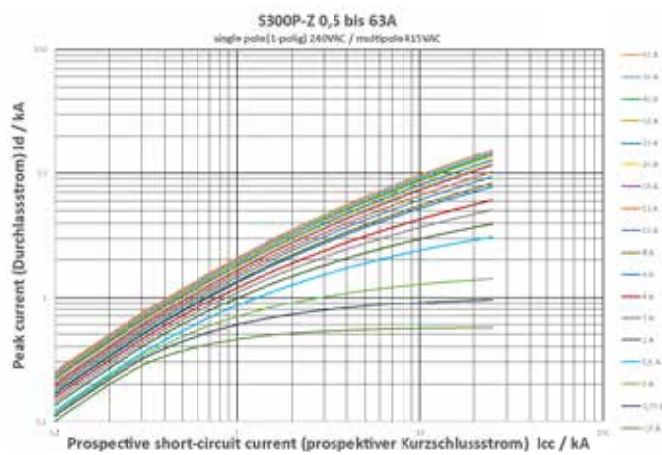

MCBs technical details

Limitation of specific let-through energy I^2t

SN201 L-SN201-SN201 M, characteristics B

230 V let-through energy

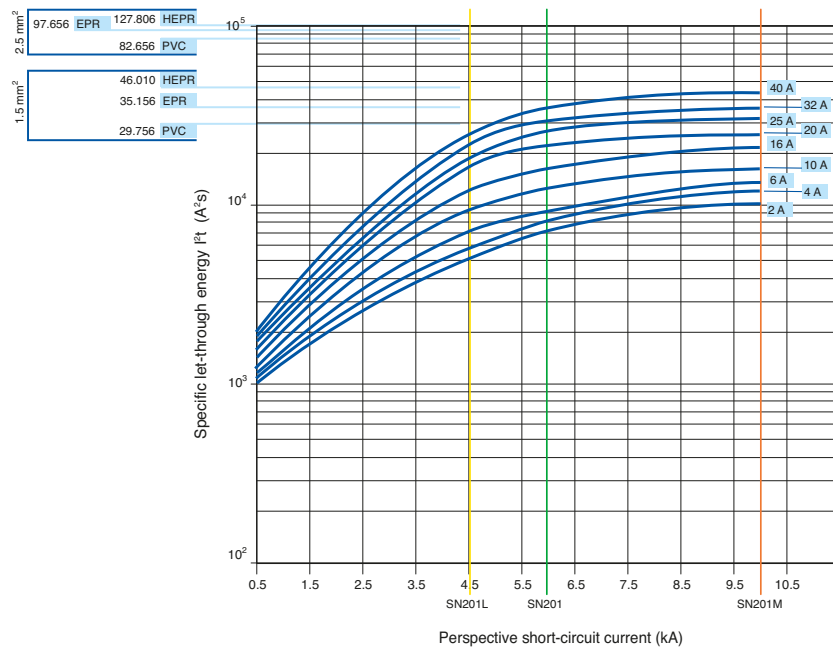

MCBs technical details

Limitation of specific let-through energy I^2t

SN201 L-SN201-SN201 M, characteristics C

230 V let-through energy

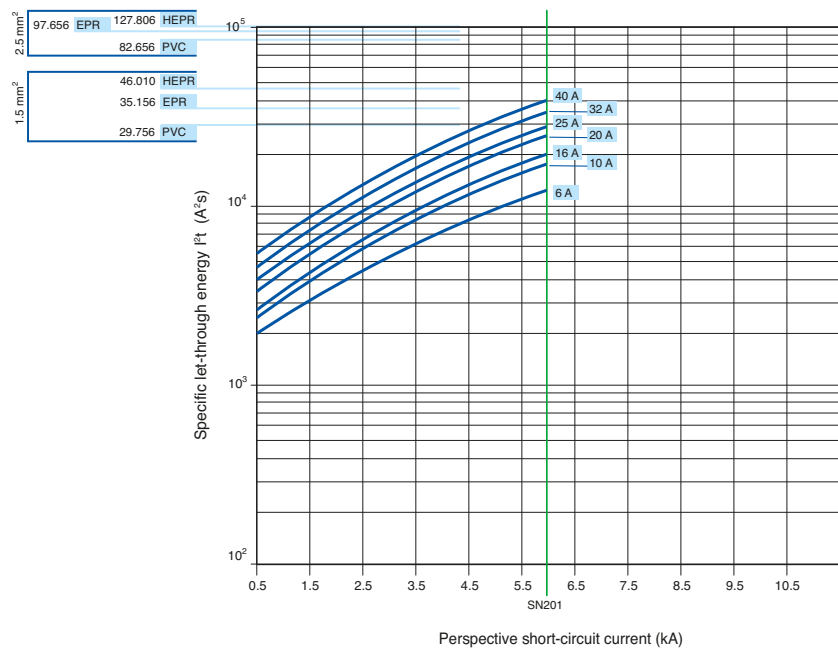
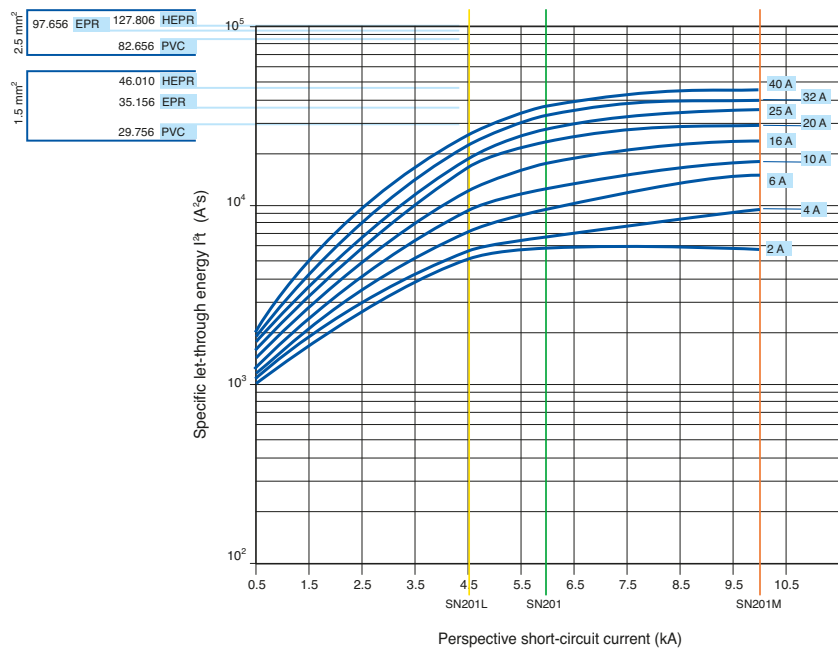

MCBs technical details

Limitation of specific let-through energy I^2t

S 750 DR characteristic $E_{\text{selective}}, K_{\text{selective}}$

diagram of let-through values

I^2t 16 ... 100 A

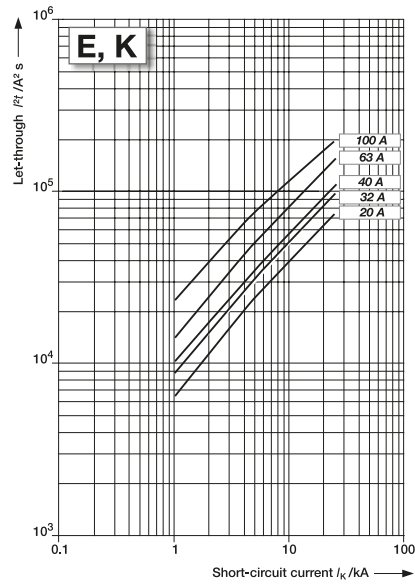
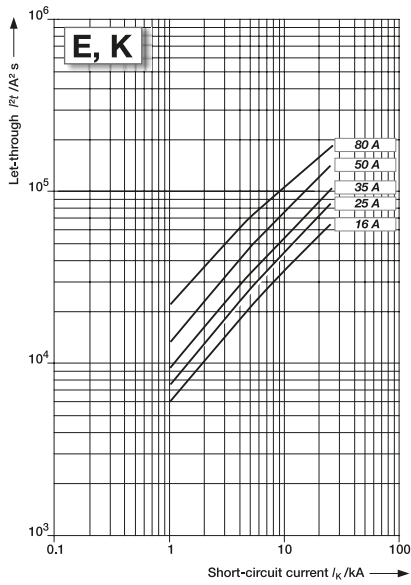

MCBs technical details

Limitation of specific let-through energy I^2t

S800 S characteristics B, C, D and K

230 V let-through energy

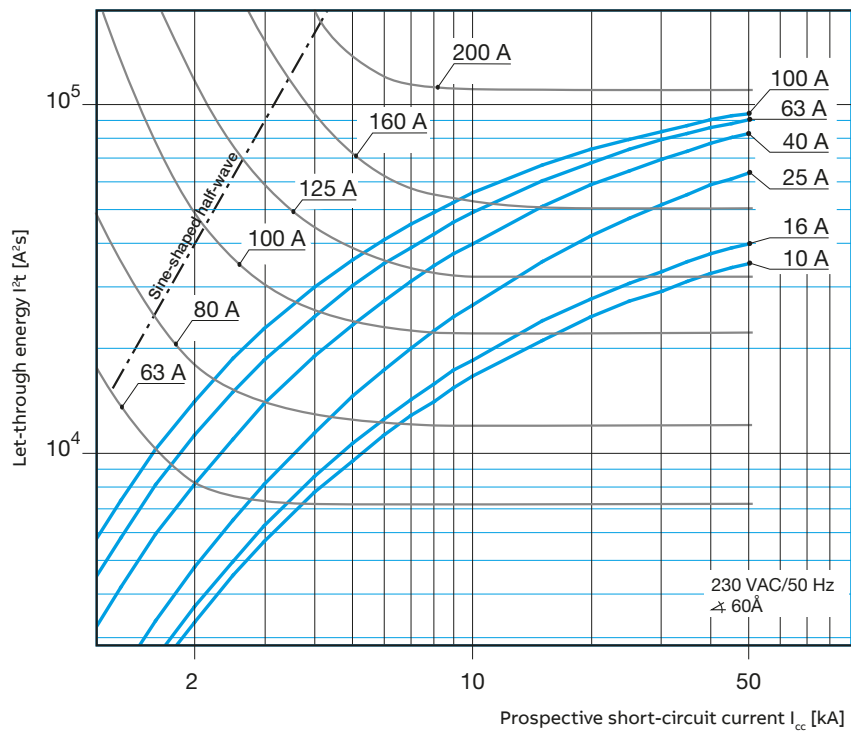
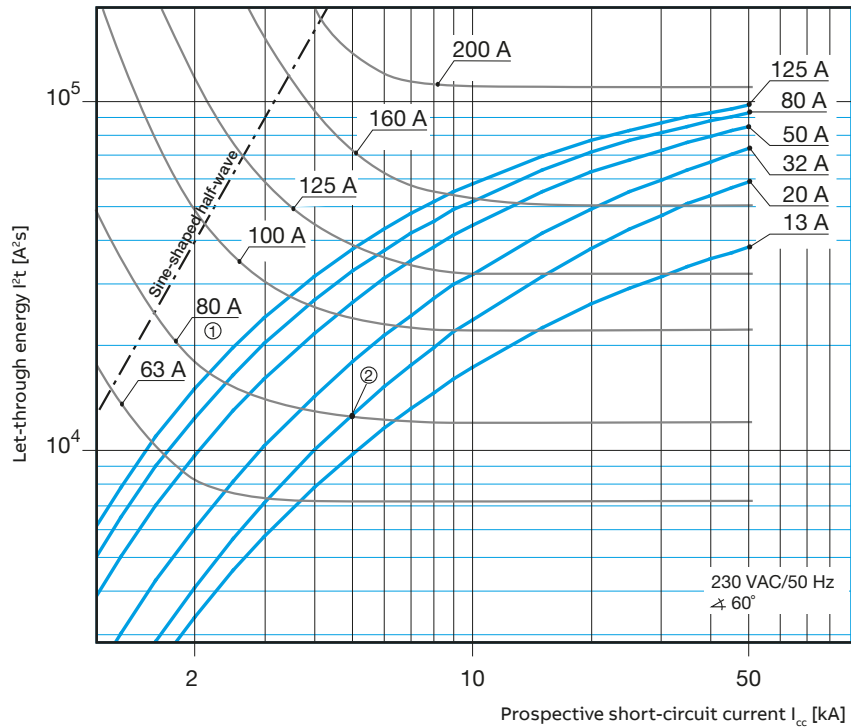

① Min. pre-arching I^2t , e.g. NH80 A gL/gG

② Max. let-through I^2t , e.g. S801S-C20

Selectivity with respect to the upstream fuse to the point of intersection of both curves 1 and 2, e.g. S801S-C20 to NH80A gL/gG: Selectivity up to min. 5 kA.

MCBs technical details

Limitation of specific let-through energy I^2t

S800 S characteristics B, C, D and K

400 V let-through energy

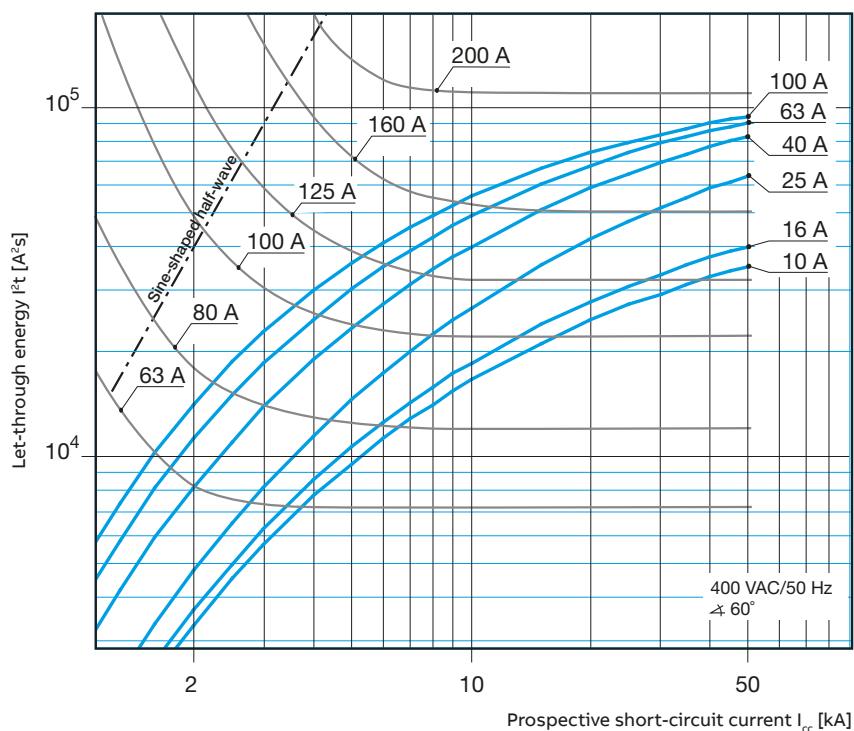
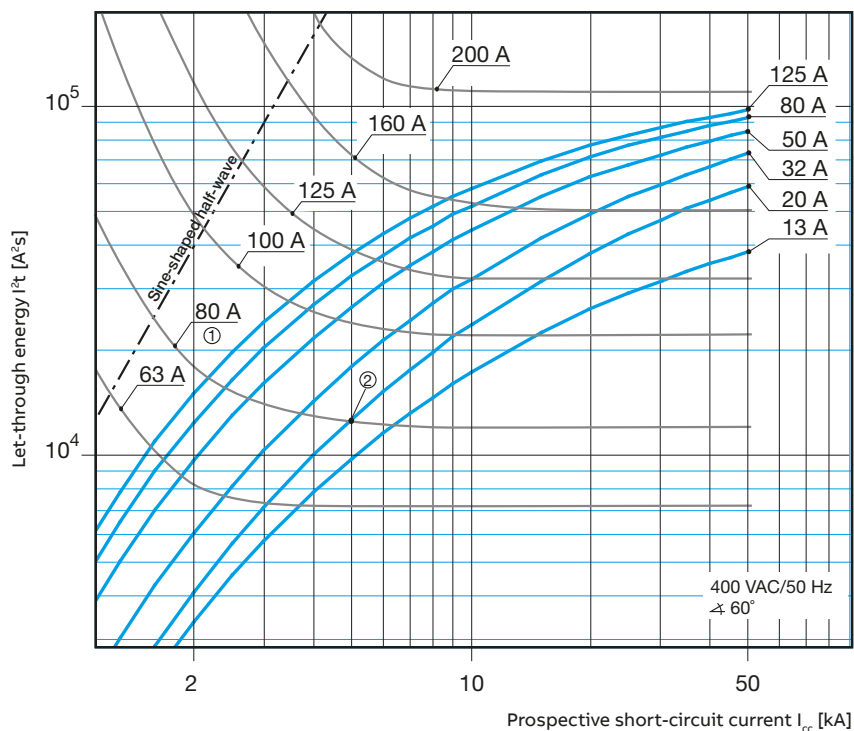

① Min. pre-arching I^2t , e.g. NH80 A gL/gG

② Max. let-through I^2t , e.g. S803S-C20

Selectivity with respect to the upstream fuse to the point of intersection of both curves 1 and 2, e.g. S801S-C20 to NH80A gL/gG: Selectivity up to min. 5 kA.

MCBs technical details

Limitation of specific let-through energy I^2t

S800 S characteristics B, C, D and K

440 V let-through energy

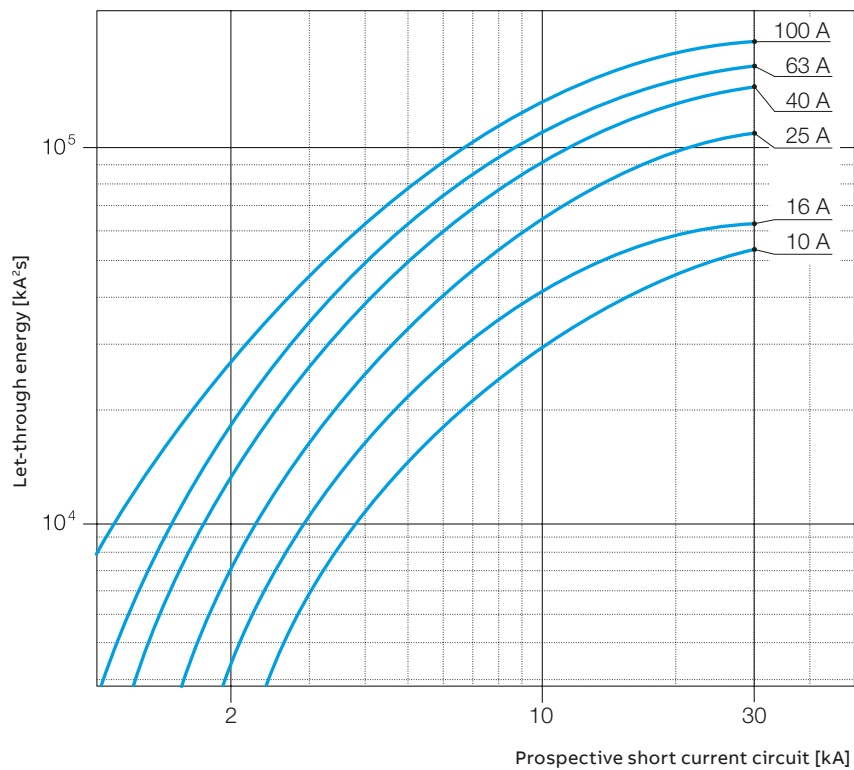
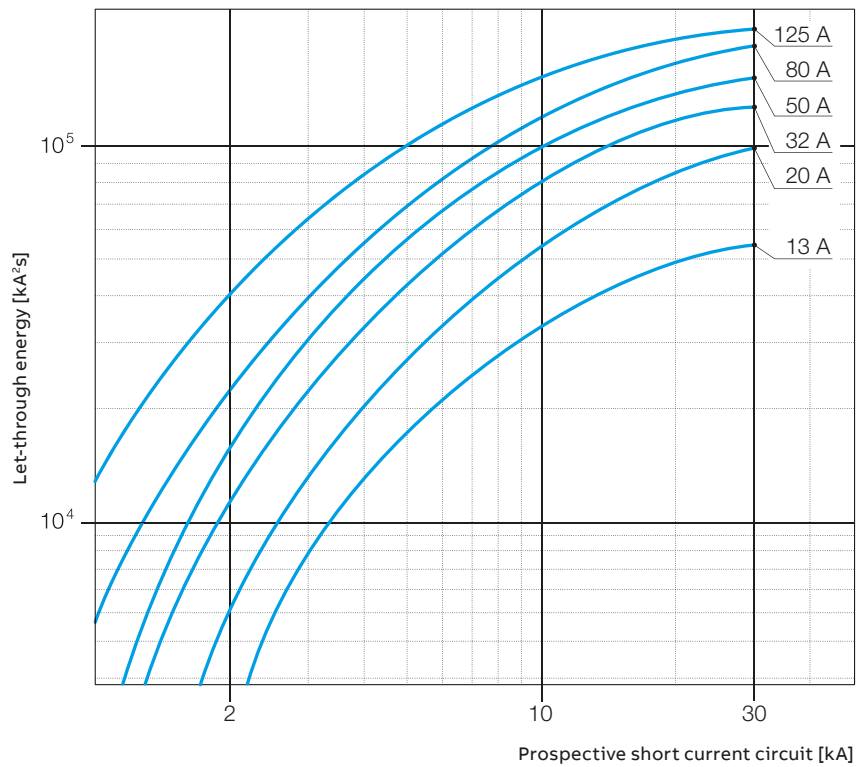

MCBs technical details

Limitation of specific let-through energy I^2t

S800 S characteristics B, C, D and K

690 V let-through energy

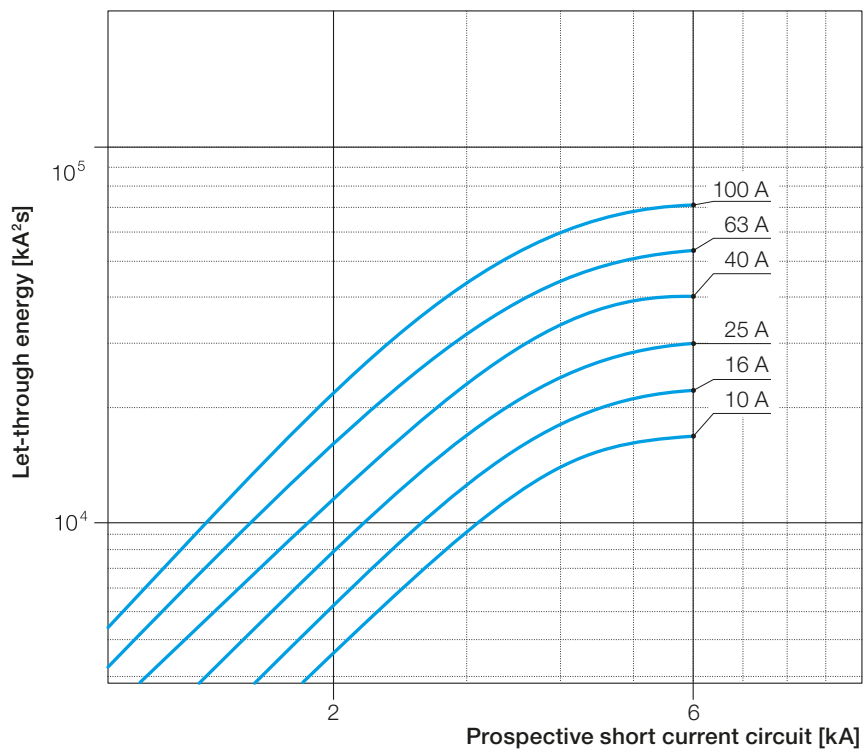
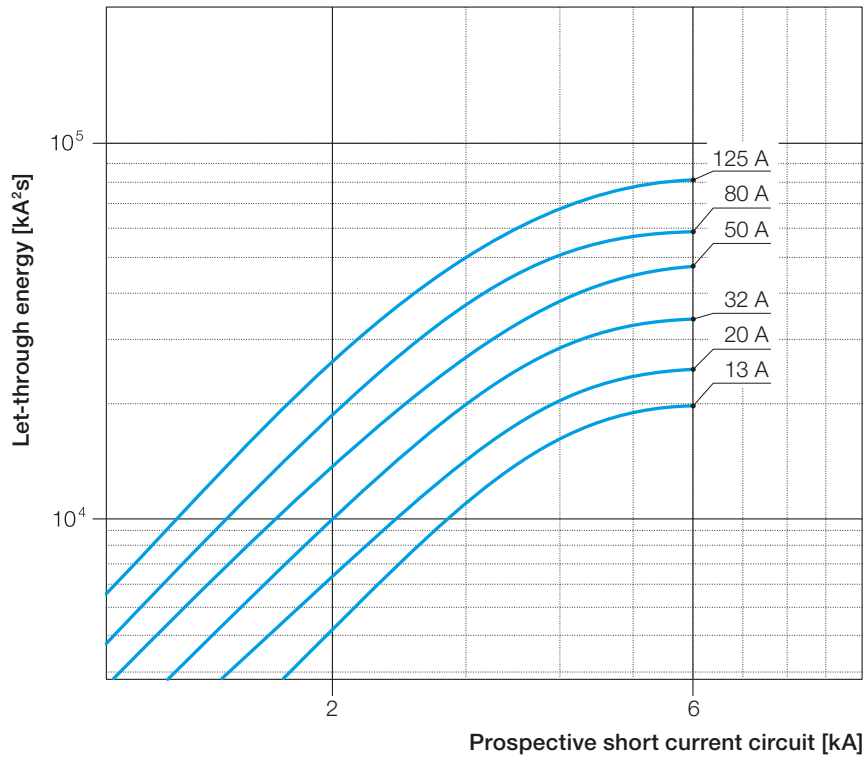

MCBs technical details

Limitation of specific let-through energy I^2t

S800 N characteristics B, C and D

230 V let-through energy

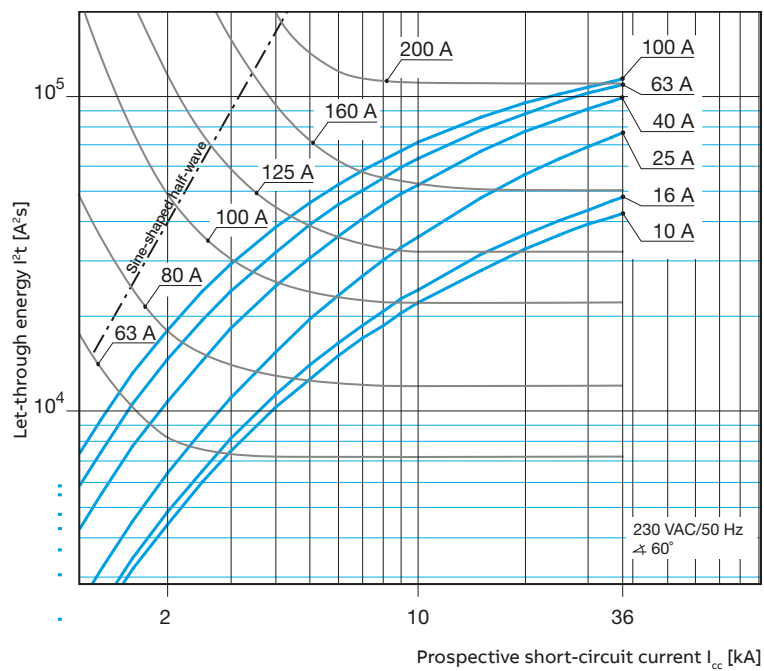
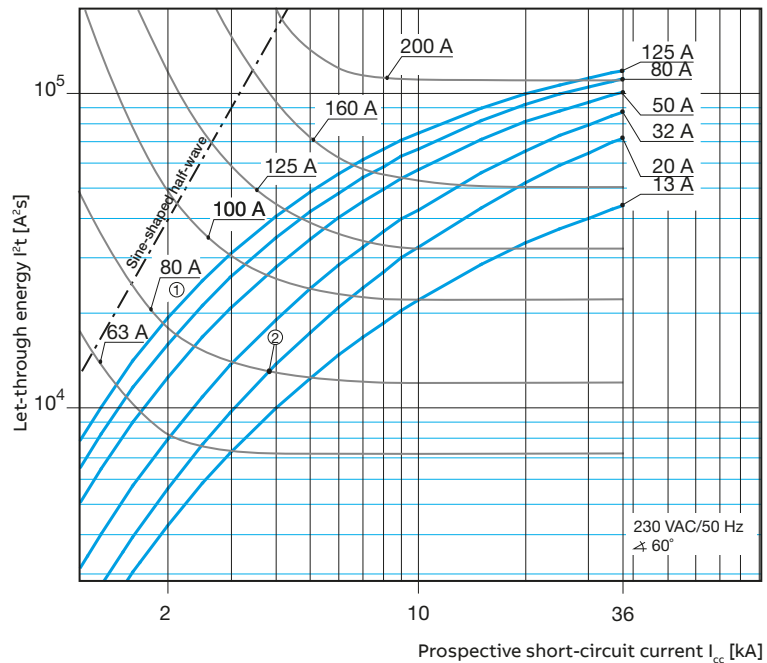

① Min. pre-arching I^2t , e.g. NH80 A gL/gG

② Max. let-through I^2t , e.g. S801N-C20

Selectivity with respect to the upstream fuse to the point of intersection of both curves 1 and 2, e.g. S801N-C20 to NH80A gL/gG: Selectivity up to min. 3.8 kA.

MCBs technical details

Limitation of specific let-through energy I^2t

S800 N characteristics B, C and D

400 V let-through energy

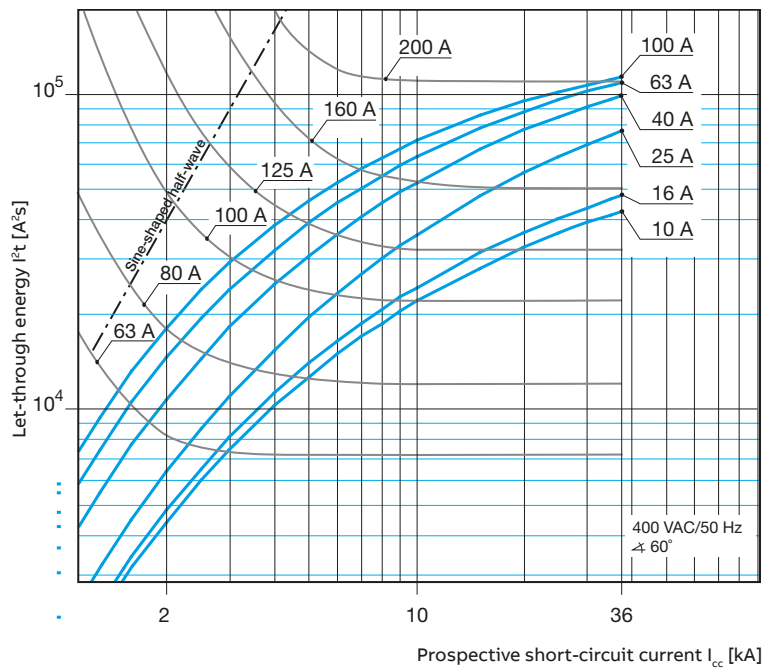
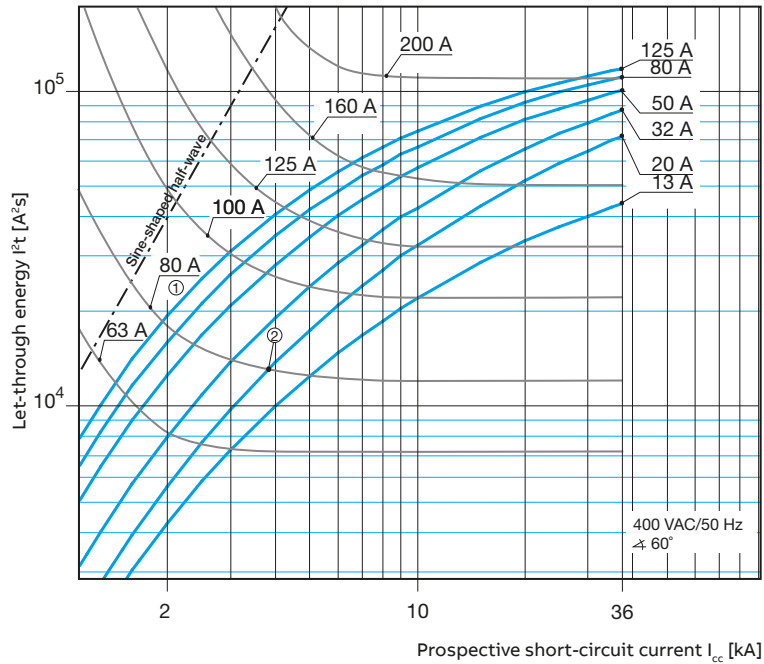

① Min. pre-arching I^2t , e.g. NH80 A gL/gG
 ② Max. let-through I^2t , e.g. S803N-C20

Selectivity with respect to the upstream fuse to the point of intersection of both curves 1 and 2, e.g. S801N-C20 to NH80A gL/gG: Selectivity up to min. 3.8 kA.

MCBs technical details

Limitation of specific let-through energy I^2t

S800 C characteristics B, C, D and K

230 V let-through energy

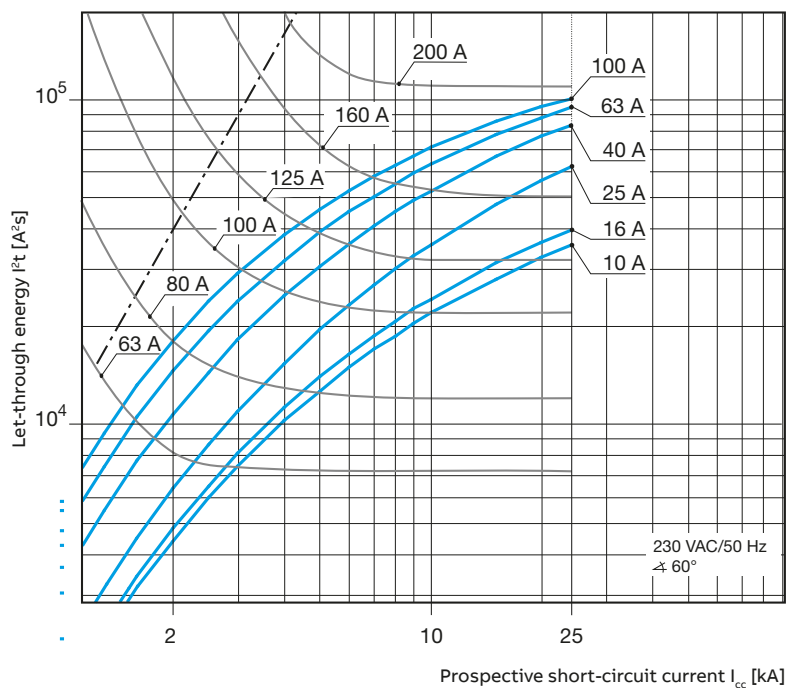
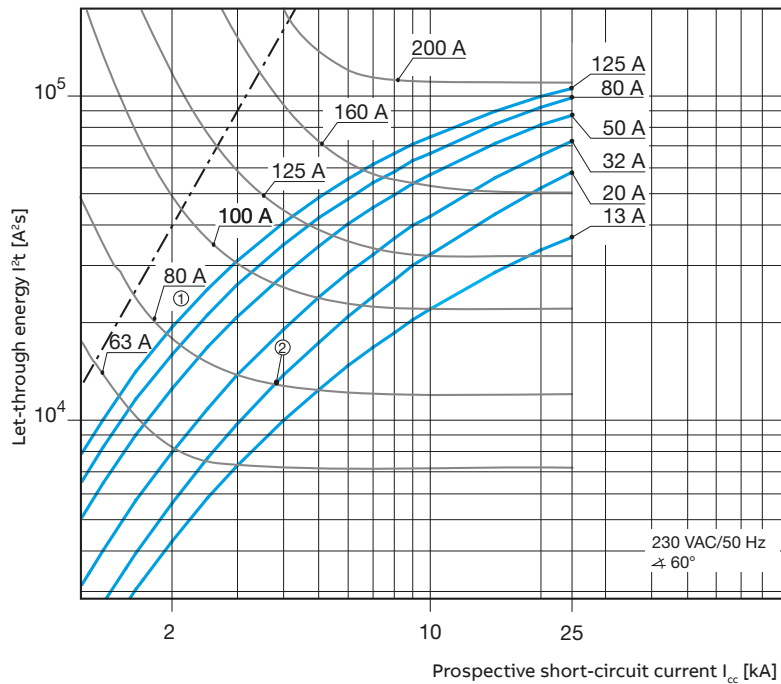

① Min. pre-arcing I^2t , e.g. NH80 A gL/gG

② Max. let-through I^2t , e.g. S801C-C20

Selectivity with respect to the upstream fuse to the point of intersection of both curves 1 and 2, e.g. S801C-C20 to NH80A gL/gG: Selectivity up to min. 3.8 kA

MCBs technical details

Limitation of specific let-through energy I^2t

S800 C characteristics B, C, D and K

400 V let-through energy

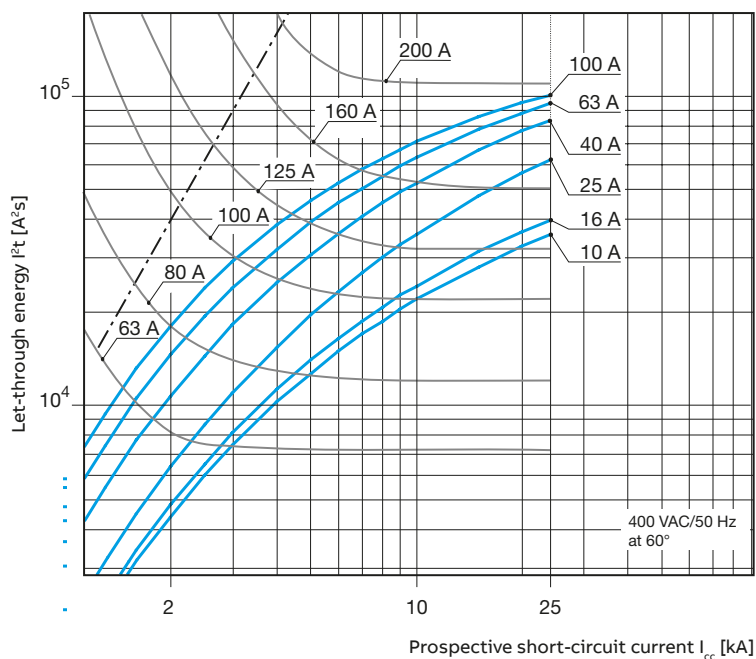
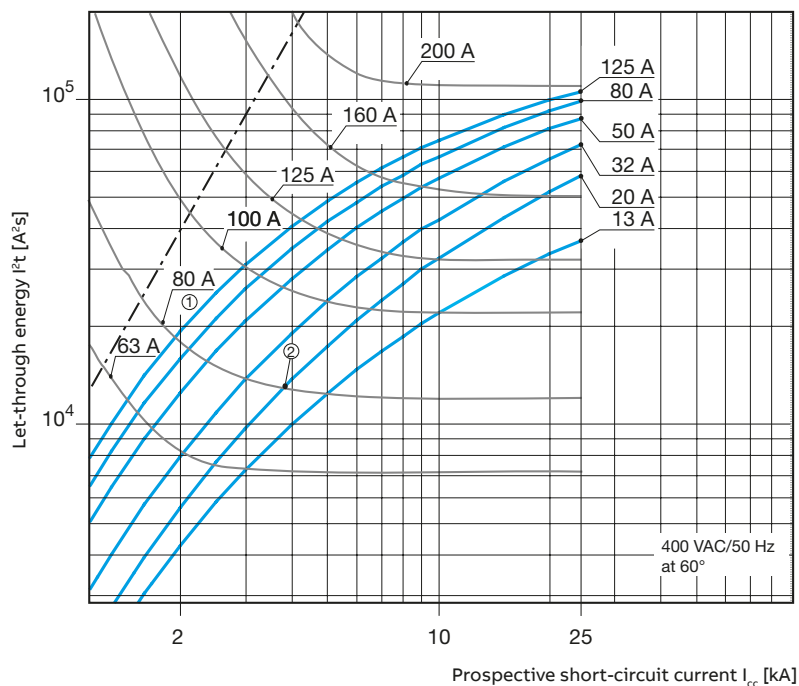

① Min. pre-arcing I^2t , e.g. NH80 A gL/gG

② Max. let-through I^2t , e.g. S803C-C20

Selectivity with respect to the upstream fuse to the point of intersection of both curves 1 and 2, e.g. S801C-C20 to NH80A gL/gG: Selectivity up to min. 3.8 kA

MCBs technical details

Limitation of specific let-through energy I^2t

S800B characteristics B, C, D and K

230/400 V let-through energy

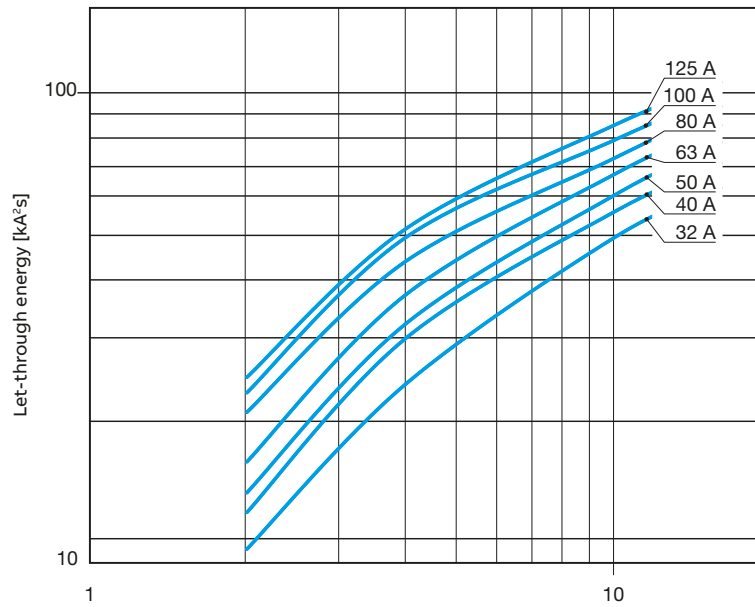

S800 U characteristics Z and K

240 V let-through energy

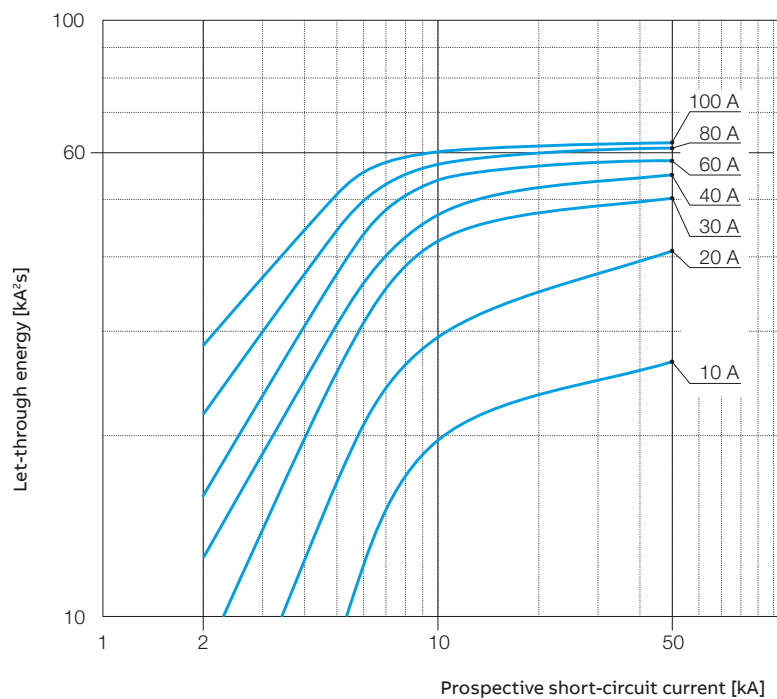

MCBs technical details

Peak current I_p

Limitation curves - Peak current values

The I_p curves give the values of the peak current, expressed in kA, in relation to the perspective symmetrical short-circuit current (kA).

S 200-S 200 M-S 200 P, characteristics B-C; DS 200-DS 200 M, characteristics B-C

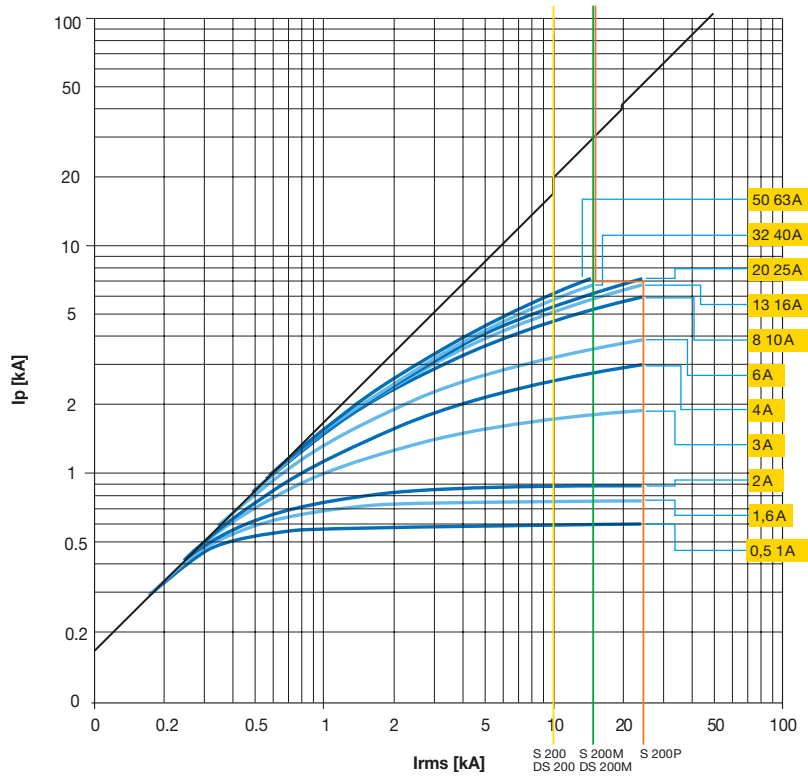

S 200-S 200 M-S 200 P, characteristics K-D

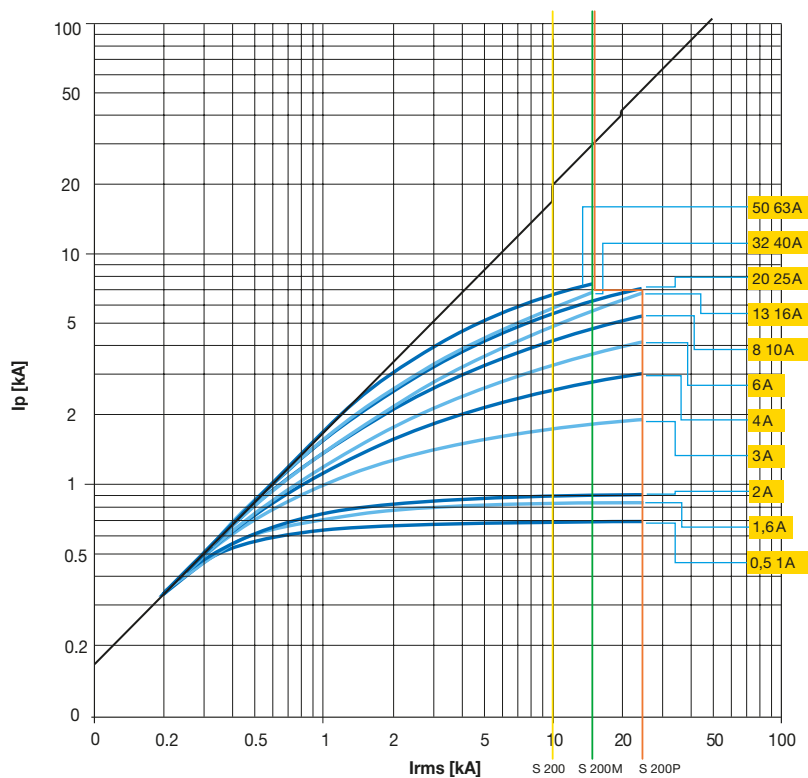

MCBs technical details

Peak current I_p

S 200-S 200 M-S 200 P, characteristic Z

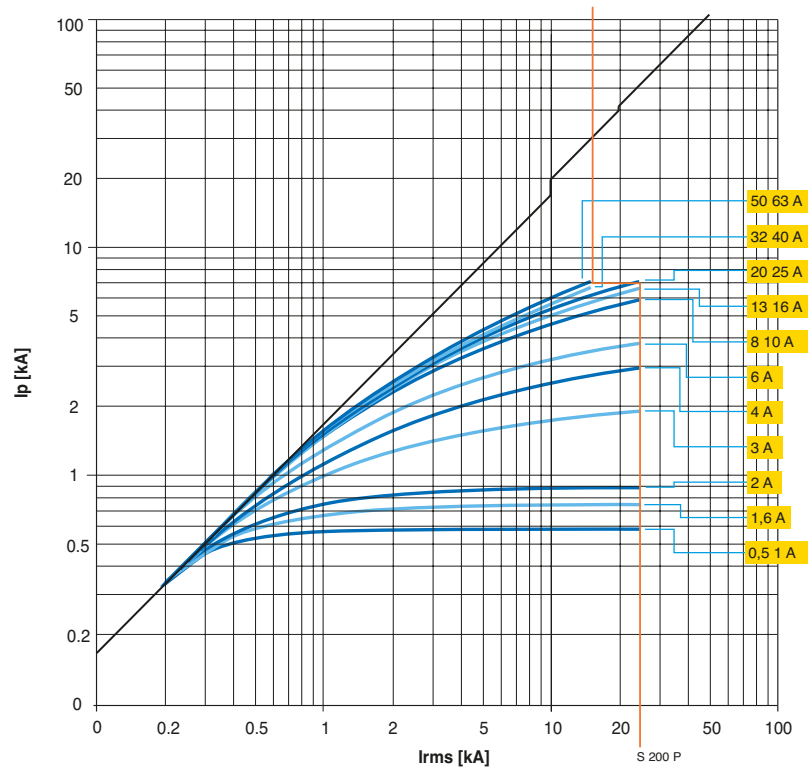

SN 201 L, SN 201, SN 201 M, characteristic B

230 V

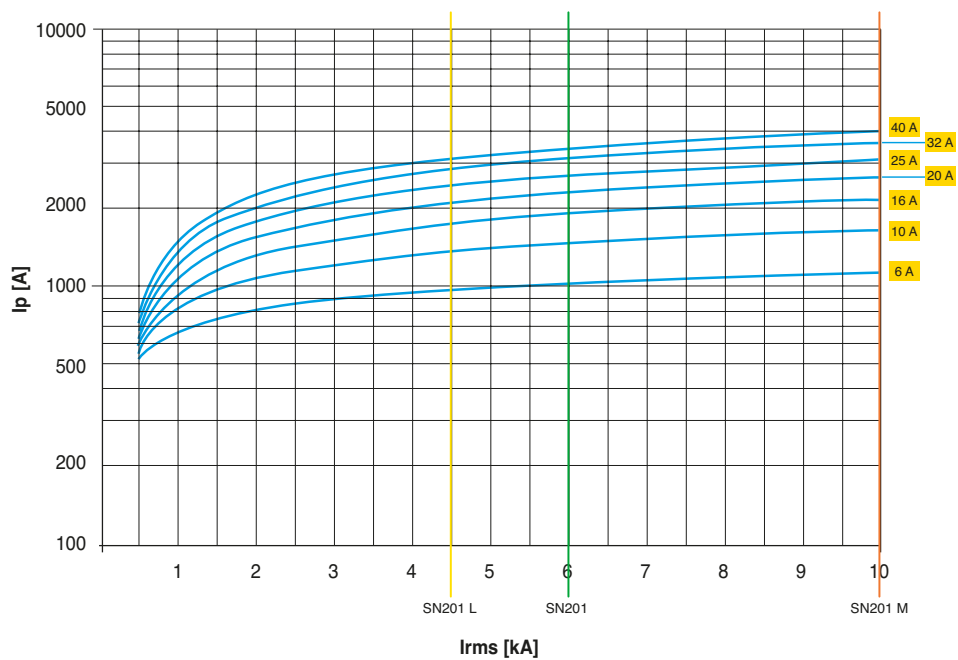

MCBs technical details

Peak current I_p

SN 201 L, SN 201, SN 201 M, characteristic C

230 V

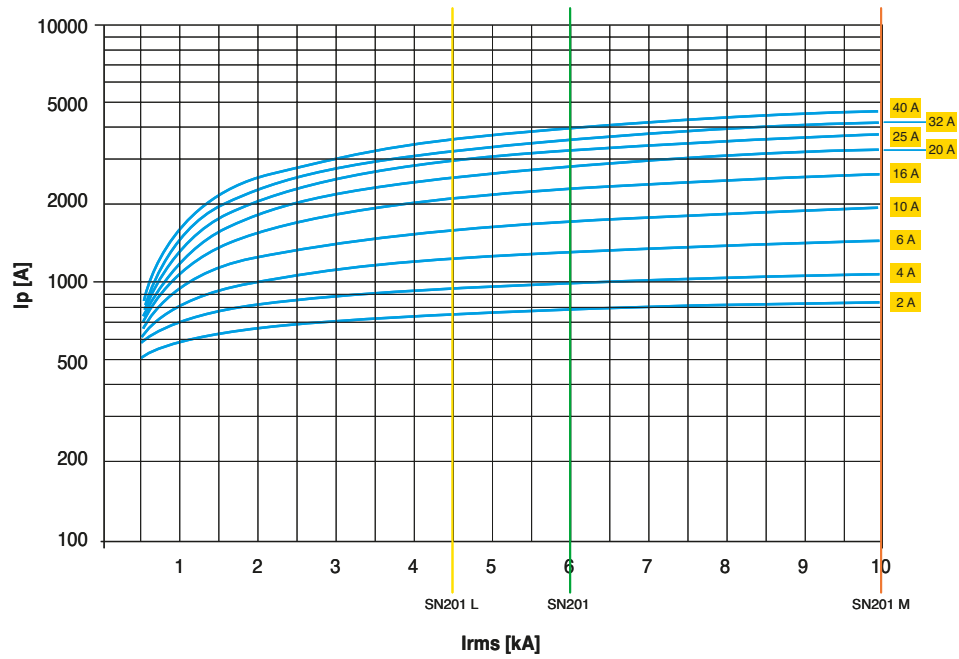

SN 201, characteristic D

230 V

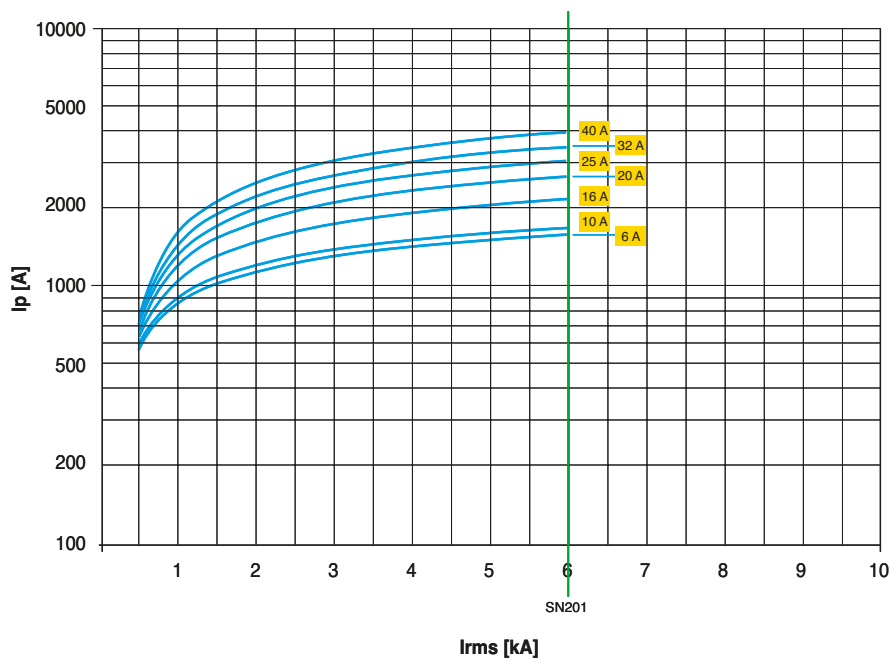

MCBs technical details

Peak current I_p

S 750 DR characteristics $E_{\text{selective}}, K_{\text{selective}}$

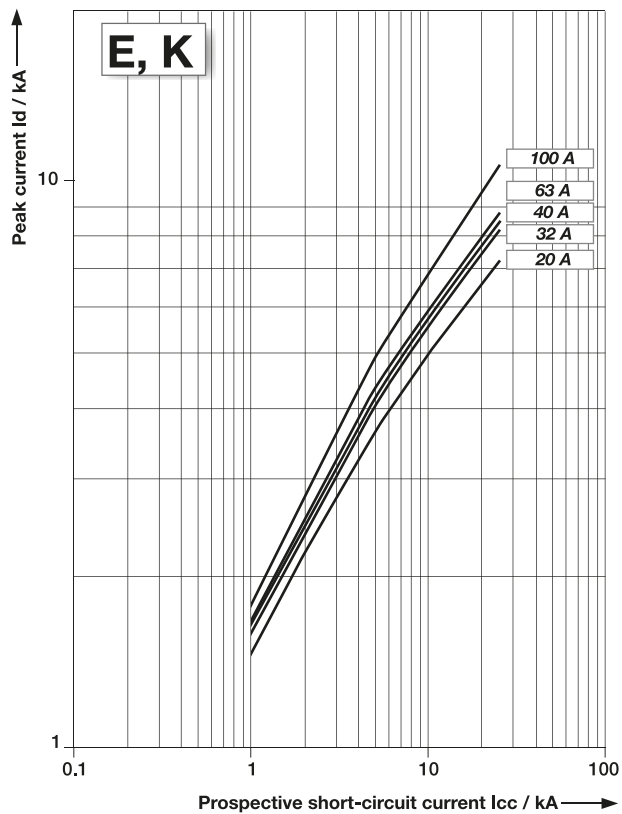
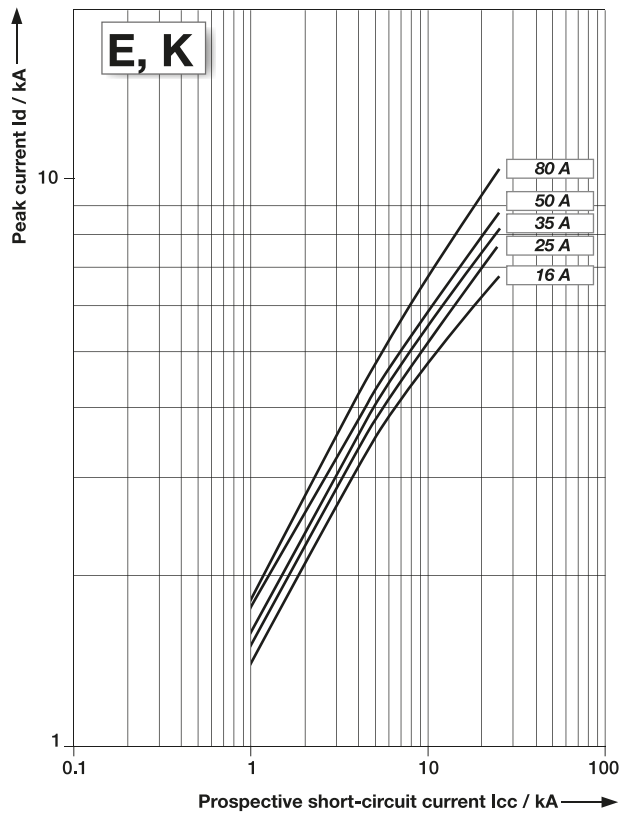

MCBs technical details

Peak current I_p

S 800 S characteristics B, C, D and K

230/400 V let-through current

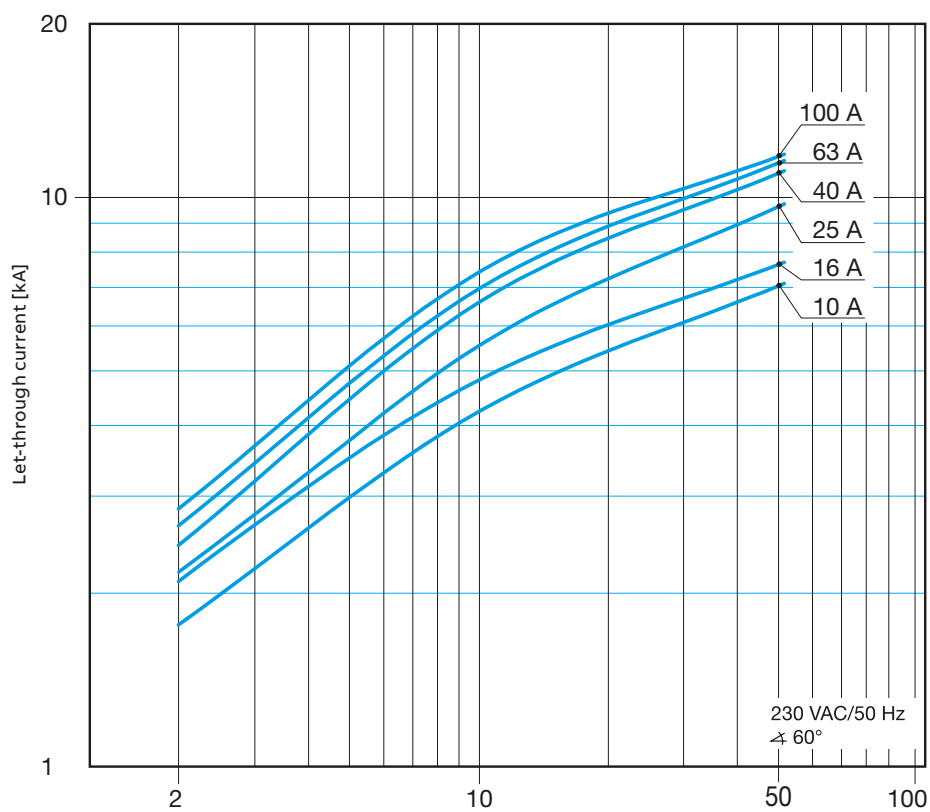
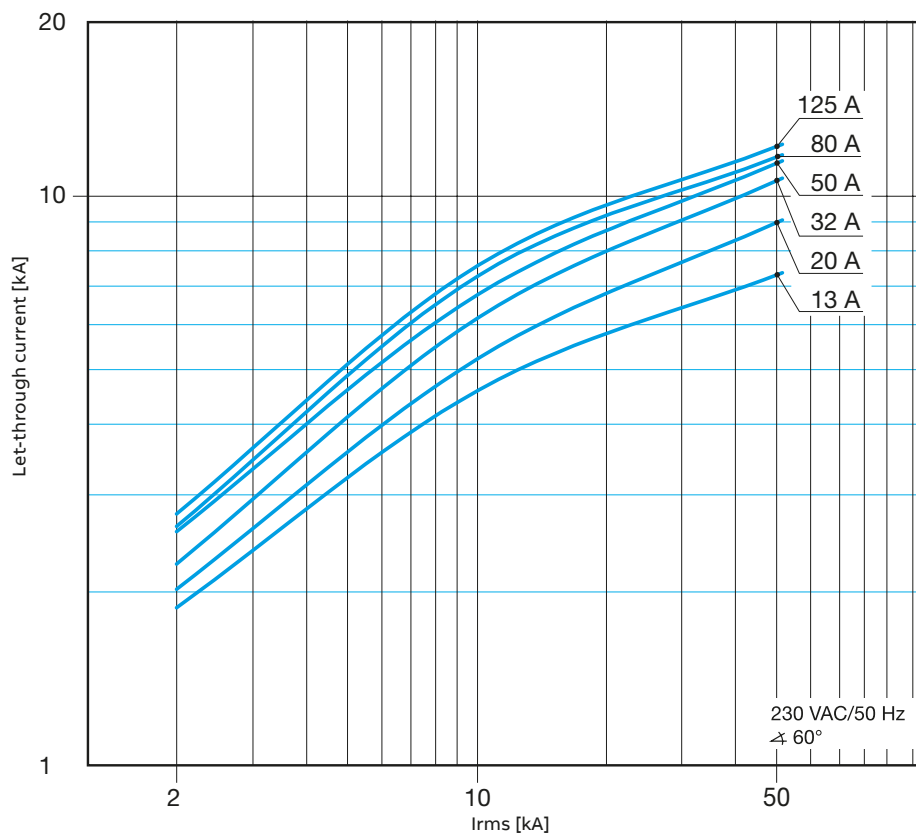

MCBs technical details

Peak current I_p

S 800 S characteristics B, C, D and K

440 V let-through current

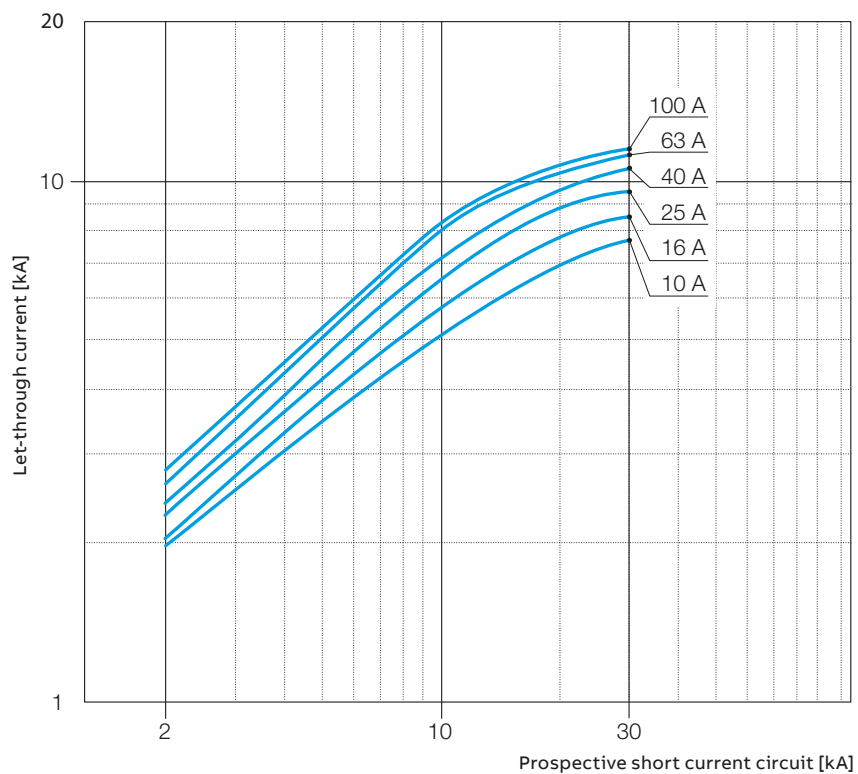
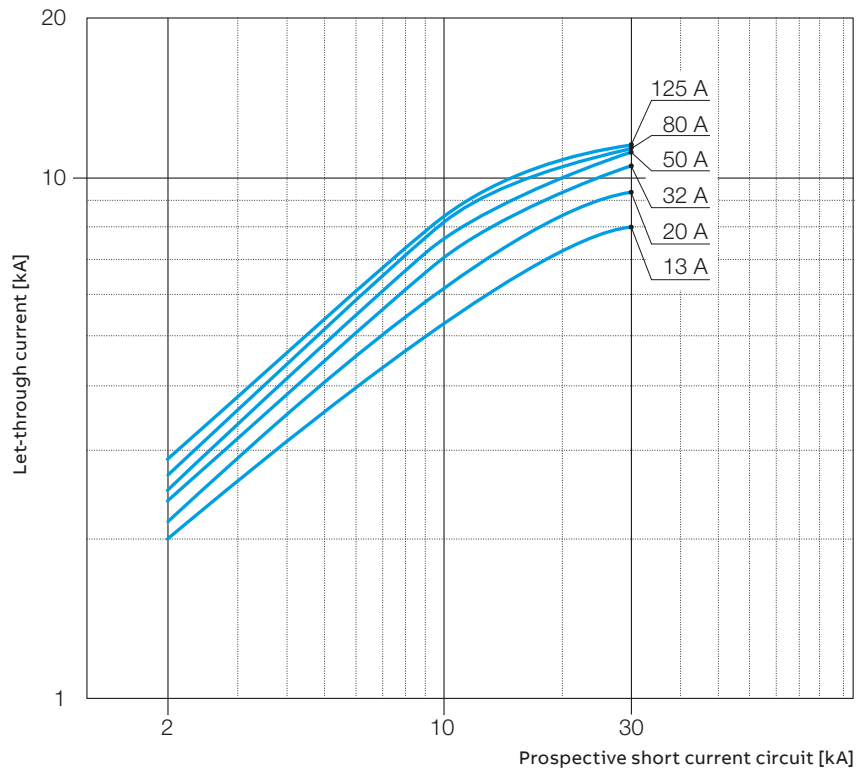

MCBs technical details

Peak current I_p

S 800 S characteristics B, C, D and K

690 V let-through current

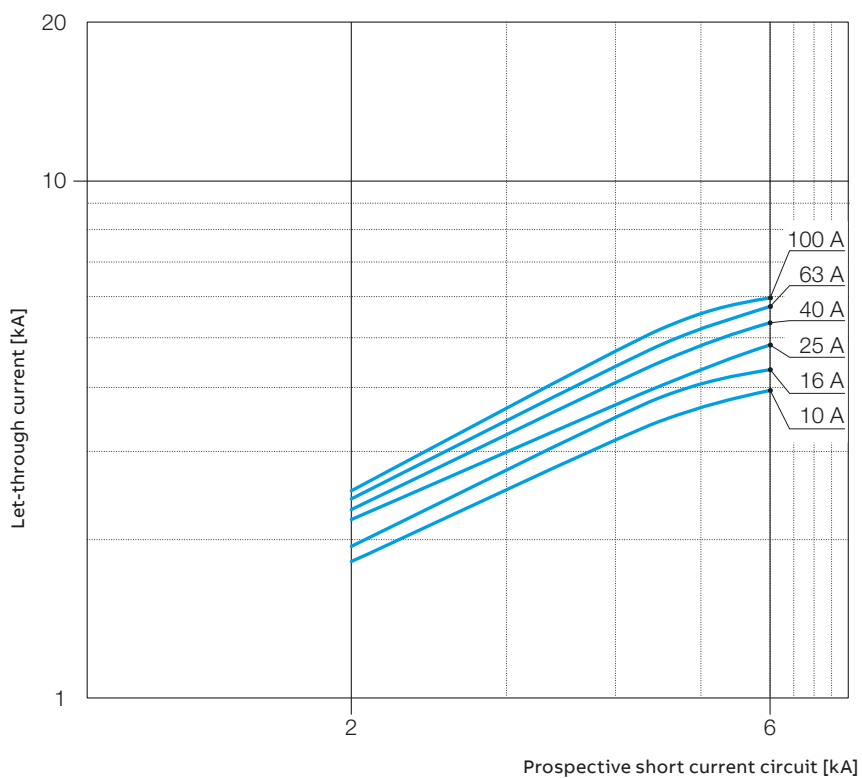
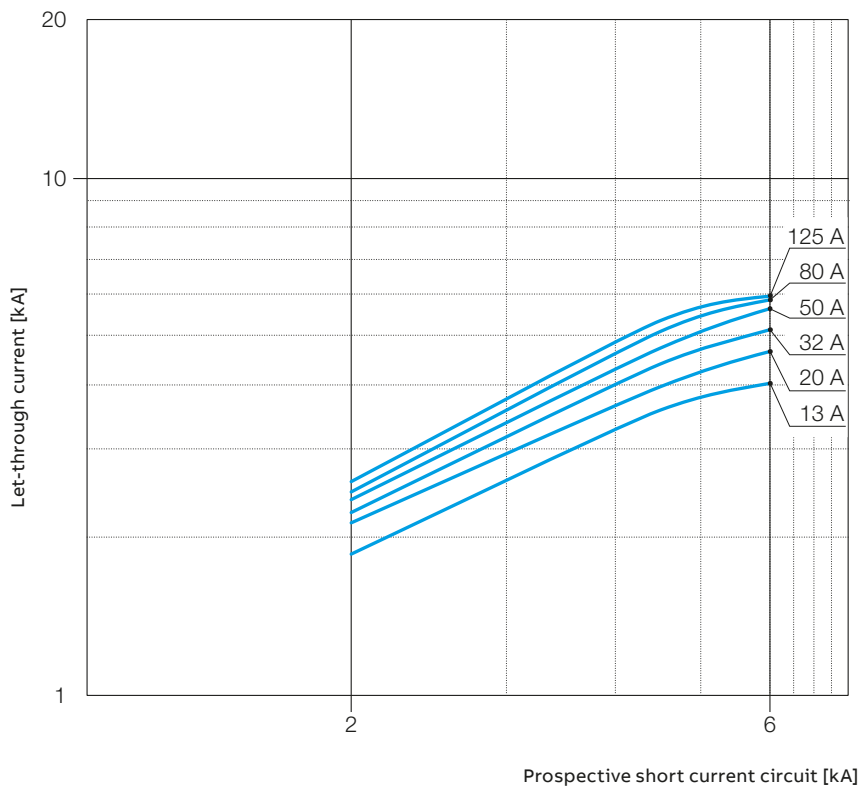

MCBs technical details

Peak current I_p

S 800 N characteristics B, C and D

230/400 V let-through current

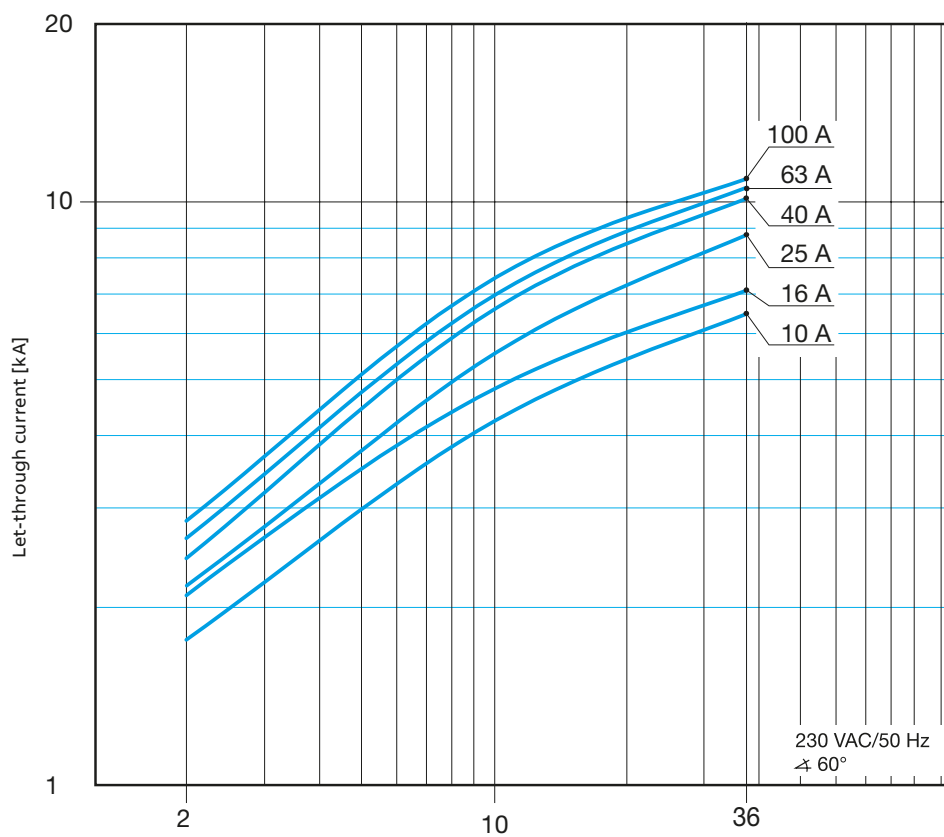
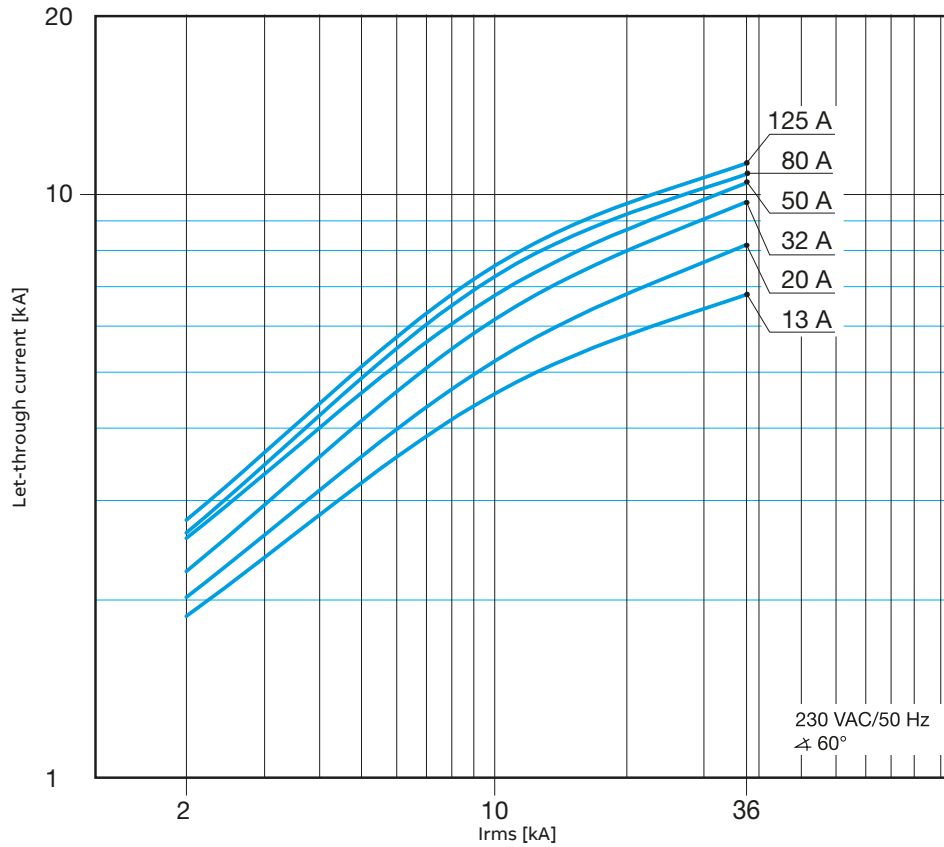

MCBs technical details

Peak current I_p

S 800 C characteristics B, C, D and K

230/400 V let-through current

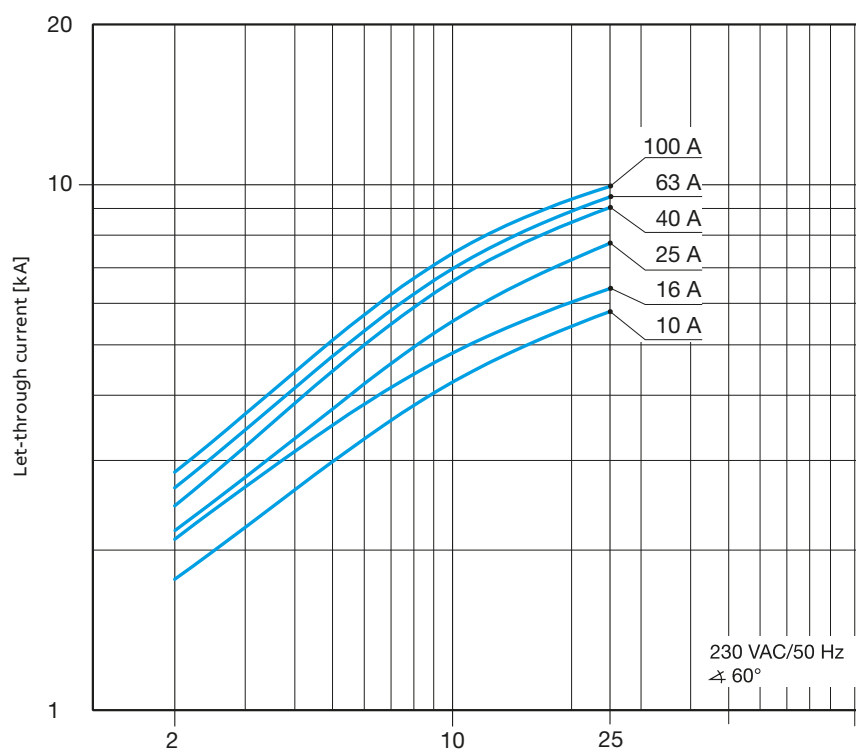
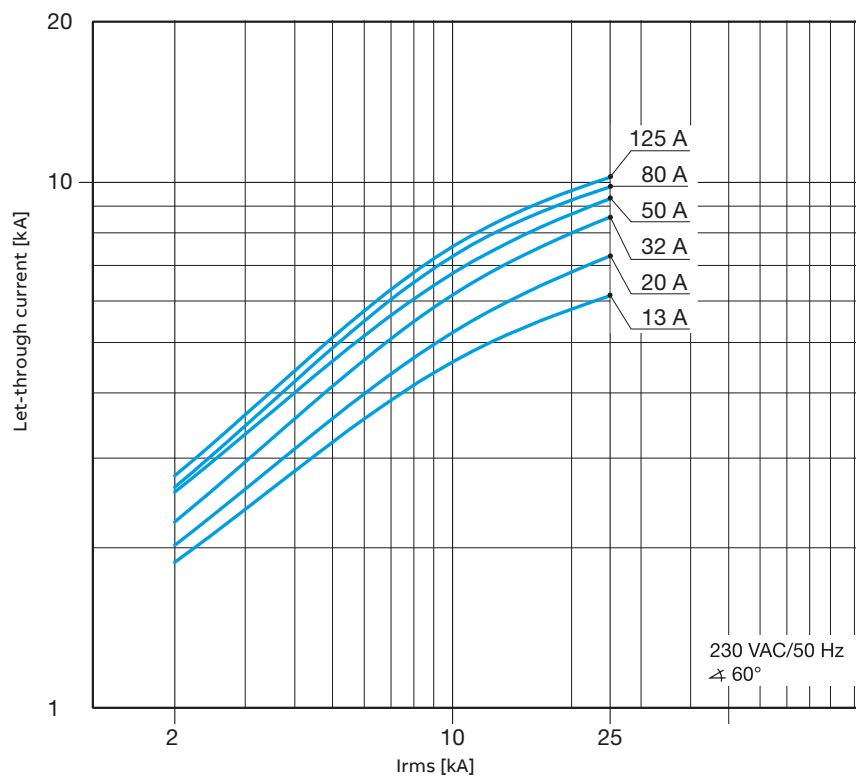

MCBs technical details

Peak current I_p

S 800 B characteristics B, C, D and K

230/400 V let-through current

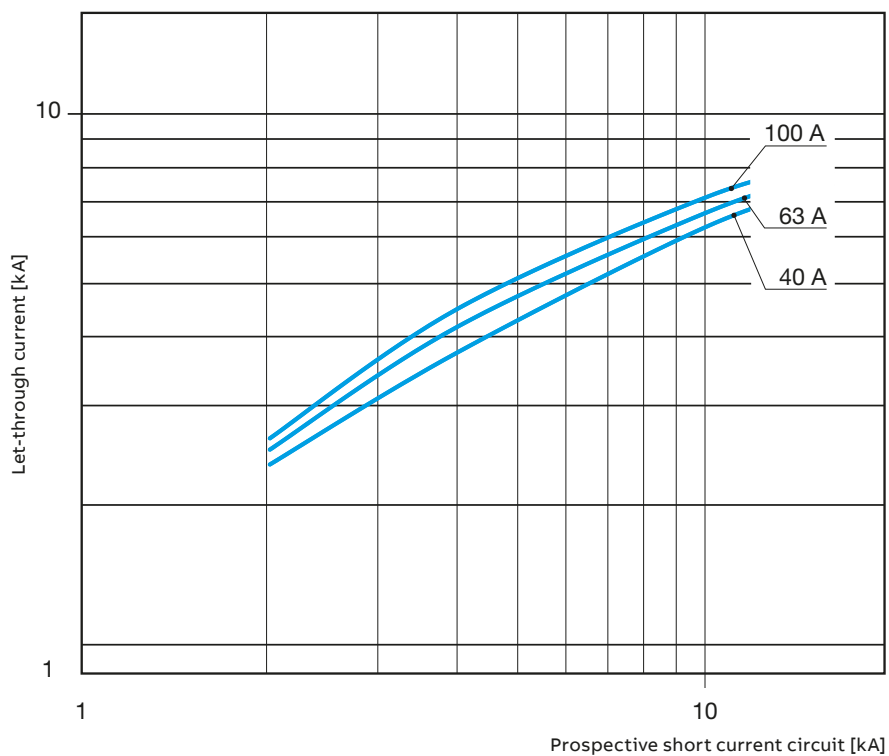
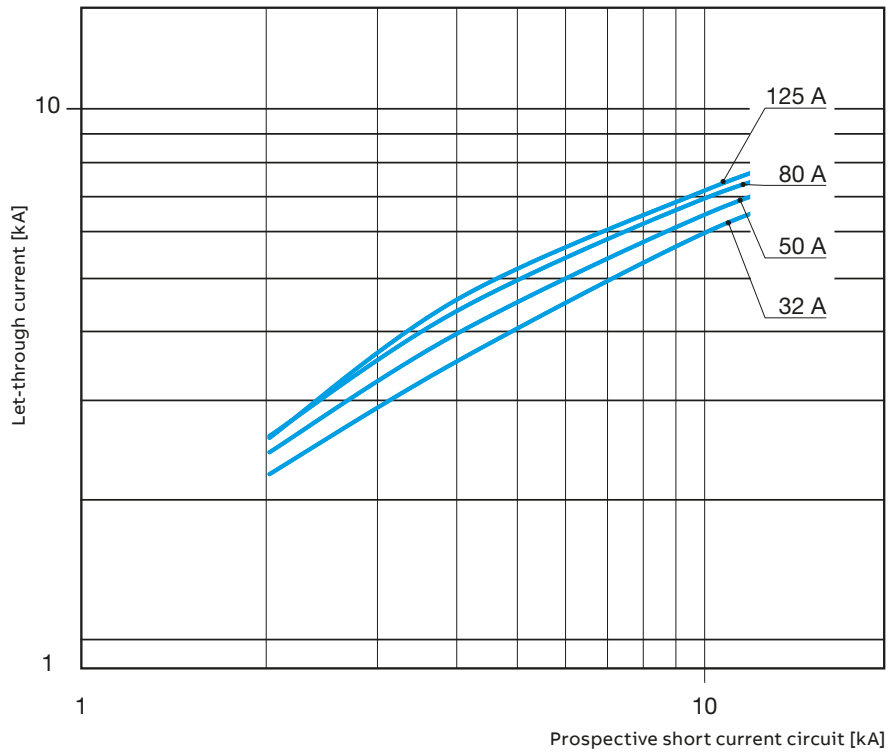

MCBs technical details

Peak current I_p

S 800 U characteristics Z and K

240 V let-through current

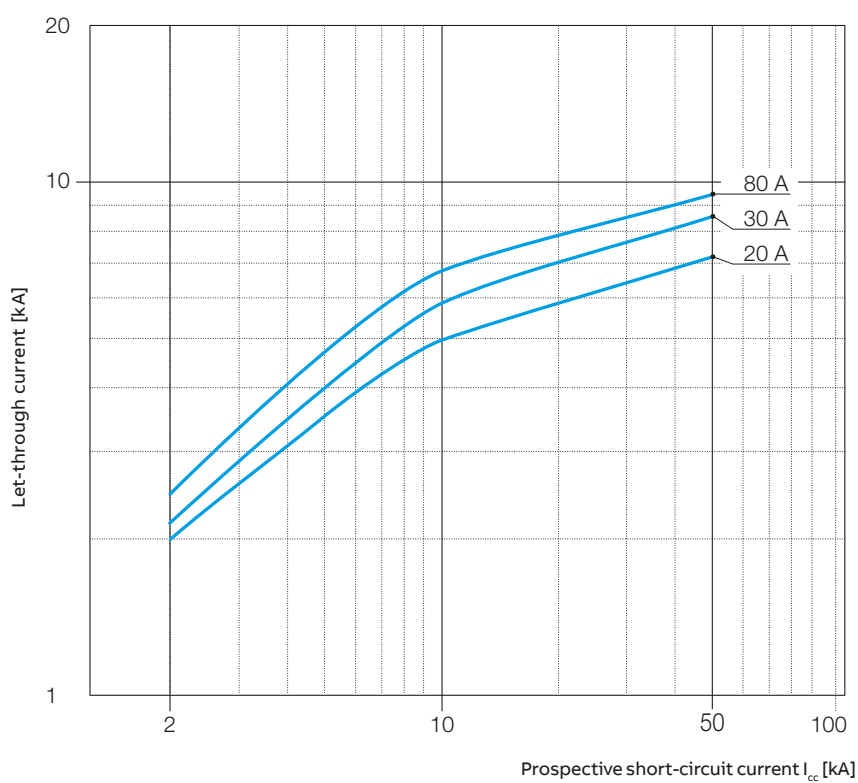
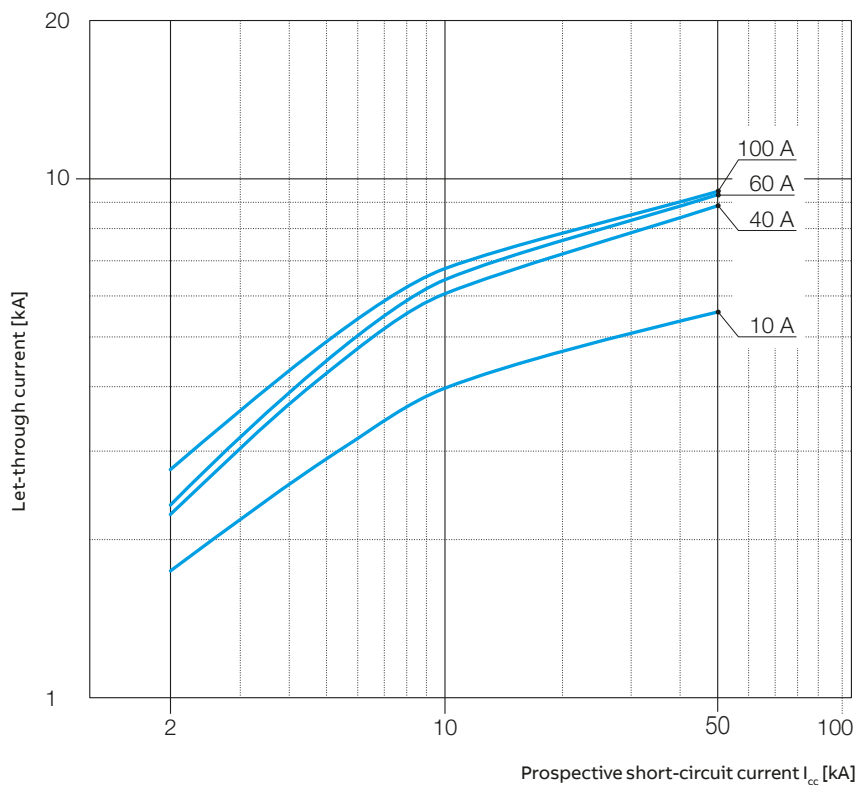

MCBs technical details

SOC - Selected Optimized Coordination



ABB is constantly improving or developing new products. Coordination between these products is therefore constantly updated. Providing always the up-to-date version in an environmental-friendly way the World Wide Web is a perfect platform. Therefore ABB offers a new tool online, SOC – Selected Optimized Coordination.

SOC is a web tool for the selection of ABB products in these applications:

- Motor starting and protection
- Selectivity between protection devices
- Back-up protection
- Other devices protection

Please check out under:

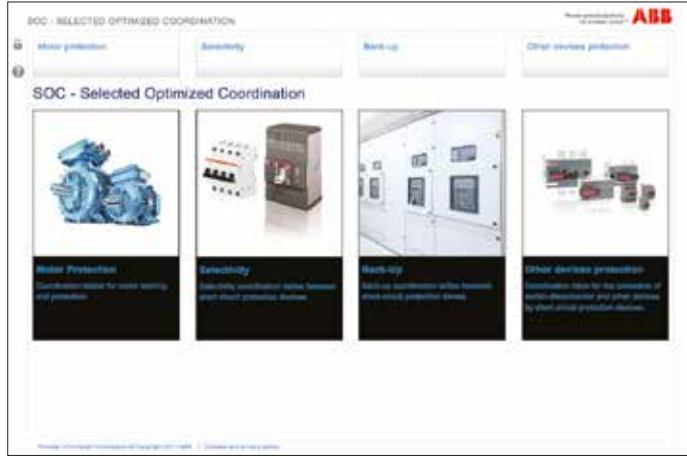
http://applications.it.abb.com/SOC_SNB

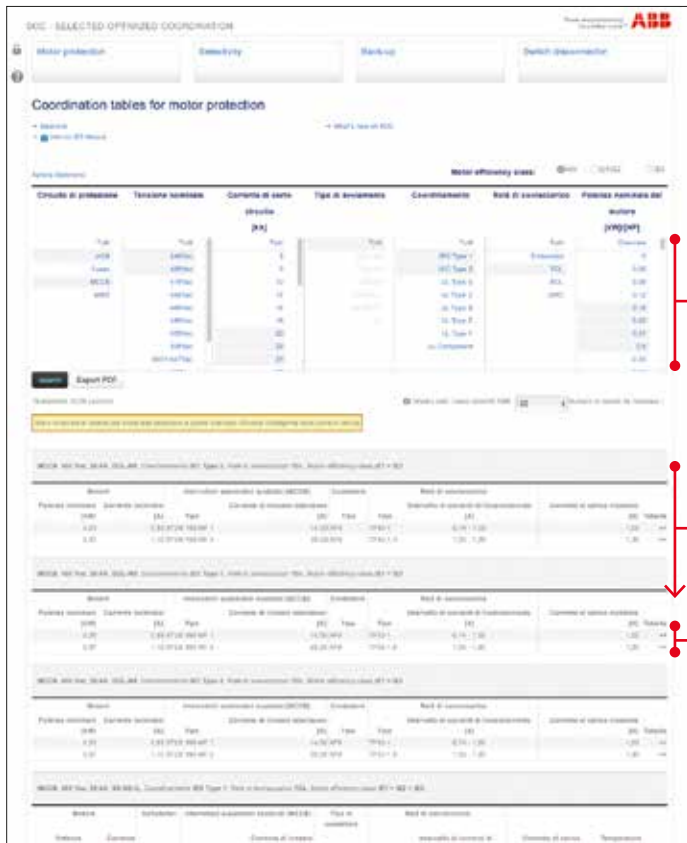

In the on line coonfigurator you can choose among many filters, it is possible to select more than one filter at the same time.

Results are shown in the bottom part of the page. If a search does not produce any result, “Smart Search” will show the closest tables matching the search criteria.

Click on “>>” on the rightmost part of each record, to view the whole coordination table, tables can be printed or saved as PDF files.



MCBs technical details

Coordination tables

Back-up protection

The tables given provide the value (in kA, referring to the breaking capacity according to the IEC 60947-2 Standard) for which the back-up protection among the combination of selected circuit-breakers is verified. The tables cover the possible combinations between ABB SACE Tmax series of moulded-case circuit-breakers and those between the above-mentioned circuit-breakers and the ABB series of modular circuit-breakers.

The values indicated in the tables refer to the voltage:

- Vn of 230/240 V AC for coordination with modular SN 201 circuit-breakers
- Vn of 400/415 V AC for all the other coordinations.

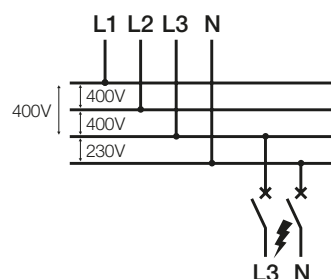

Note

The following tables give the breaking capacities at 415 V AC for circuit-breakers SACE Tmax.

Tmax @ 415 V AC	
Version	Icu [kA]
B	16
C	25
N	36
S	50
H	70
L (T2)	85
L (T4, T5)	120
V	200

Caption

MCB = miniature circuit-breakers (SN 201, S 2, S 800)
 MCCB = moulded-case circuit-breakers (Tmax)

For moulded-case or air circuit-breakers:

- TM = thermomagnetic release
- TMD (Tmax)
 - TMA (Tmax)
- M = magnetic only release
- MF (Tmax)
 - MA (Tmax)
- EL = electronic release
- PR221DS - PR222DS (Tmax)

Selective protection

The tables given provide the value (in kA, referring to the breaking capacity according to the IEC 60947-2 Standard) for which the selective protection is verified among the combination of selected circuit-breakers. The tables cover the possible combinations between ABB SACE Tmax series of moulded-case circuit-breakers, and the ABB series of modular circuit-breakers. The values in the table represent the maximum value obtainable of discrimination between supply side circuit-breaker and load side circuit-breaker referring to the voltage:

- Vn of 230/240 V AC for the SN 201 circuit-breakers and Vn of 400/415 V AC for the supply side circuit-breakers in the coordination between MCB with the modular SN 201 circuit-breakers (see picture).
- Vn of 400/415 V AC for all the other coordinations.

For miniature circuit-breakers:

- B = trip characteristic ($I_m=3...5I_n$)
 C = trip characteristic ($I_m=5...10I_n$)
 D = trip characteristic ($I_m=10...20I_n$)
 K = trip characteristic ($I_m=10...14I_n$)
 Z = trip characteristic ($I_m=2...3I_n$)

For solutions not shown in these tables, please consult the website: <http://bol.it.abb.com> or contact ABB SACE

For solutions not shown in these tables referring to SMISLINE or S800 please use: leaflet 2CCC451039L02xx

MCBs technical details

Coordination tables: back-up

MCB - MCB @ 415 V

Load S.	Char.	Icu [kA]	Supply S. S200		S200M		S200P		S280	
			B-C		B-C		B-C		B-C	
			10		15		25		15	
			In [A]	0.5..63	0.5..63	0.5..25	32..63	80, 100		
S200	B,C,K,Z	10	0.5..63		15	25	15			
S200M	B,C	15	0.5..63			25				
S200P	B,C, D,K,Z	25	0.5..25							
		15	32..63							

S800S – SN201 @ 230/240 V

Load s.	Char.	Icu [kA]	Supply s. S800S		B, C, D, K							
			50									
			In [A]	25	32	40	50	63	80	100	125	
SN201	B, D	10	6	50	50	50	50	50	50	50	50	50
			10	50	50	50	50	50	50	50	50	50
			16	50	50	50	50	50	50	50	50	50
			20		50	50	50	50	50	50	50	50
			25			50	50	50	50	50	50	50
			32				50	50	50	50	50	50
			40					50	50	50	50	50

S800S – SN201 @ 230/240 V

Load s.	Char.	Icu [kA]	Supply s. S800S		B, C, D, K							
			50									
			In [A]	25	32	40	50	63	80	100	125	
SN201	C	10	2	50	50	50	50	50	50	50	50	50
			4	50	50	50	50	50	50	50	50	50
			6	50	50	50	50	50	50	50	50	50
			10	50	50	50	50	50	50	50	50	50
			16	50	50	50	50	50	50	50	50	50
			20		50	50	50	50	50	50	50	50
			25			50	50	50	50	50	50	50
			32				50	50	50	50	50	50
			40					50	50	50	50	50

MCBs technical details

Coordination tables: back-up

S800S – SN201 L @ 230/240 V

Load s.	Char.	Supply s.		S800S								
		Icu [kA]	In [A]	B, C, D, K								
				50	25	32	40	50	63	80	100	125
SN201 L	B, C	6	2	50	40	25	25	18	15	15	15	
			4	50	40	25	25	18	15	15	15	
			6	50	40	25	25	18	15	15	15	
			10	50	40	25	25	18	15	15	15	
			16	50	40	25	25	18	15	15	15	
			20		40	25	25	18	15	15	15	
			25			25	25	18	15	15	15	
			32				25	18	15	15	15	
			40					18	15	15	15	

S800S – SN201 M @ 230/240 V

Load s.	Char.	Upstream		S800S								
		Icu [kA]	In [A]	B, C, D, K								
				50	25	32	40	50	63	80	100	125
SN201 M	B	10	6	50	50	50	50	50	50	50	50	50
			10	50	50	50	50	50	50	50	50	50
			16	50	50	50	50	50	50	50	50	50
			20		50	50	50	50	50	50	50	50
			25			50	50	50	50	50	50	50
			32				50	50	50	50	50	50
			40					50	50	50	50	50

S800S - SN201 M @ 230/240 V

Load s.	Char.	Supply s.		S800S								
		Icu [kA]	In [A]	B, C, D, K								
				50	25	32	40	50	63	80	100	125
SN201 M	C	10	2	50	50	50	50	50	50	50	50	
			4	50	50	50	50	50	50	50	50	
			6	50	50	50	50	50	50	50	50	
			10	50	50	50	50	50	50	50	50	
			16	50	50	50	50	50	50	50	50	
			20		50	50	50	50	50	50	50	
			25			50	50	50	50	50	50	
			32				50	50	50	50	50	

MCBs technical details

Coordination tables: back-up

S800S – S200 @230/400 V

Load s.	Char.	Supply s.		S800S								
		Icu [kA]	In [A]	B, C, D, K								
				50	25	32	40	50	63	80	100	125
S200	B	10	6	50	50	50	50	50	50	50	50	50
			10	50	50	50	50	50	50	50	50	50
			13	50	50	50	50	50	50	50	50	50
			16	50	50	50	50	50	50	50	50	50
			20		50	50	50	50	50	50	50	50
			25			50	50	50	50	50	50	50
			32				50	50	50	50	50	50
			40					50	50	50	50	50
			50						50	50	50	50
								50	50	50		
									50	50		

Load s.	Char.	Supply s.		S800S								
		Icu [kA]	In [A]	B, C, D, K								
				50	25	32	40	50	63	80	100	125
S200	C	10	0.5...6	50	50	50	50	50	50	50	50	50
			8	50	50	50	50	50	50	50	50	50
			10	50	50	50	50	50	50	50	50	50
			13	50	50	50	50	50	50	50	50	50
			16	50	50	50	50	50	50	50	50	50
			20		50	50	50	50	50	50	50	50
			25			50	50	50	50	50	50	50
			32				50	50	50	50	50	50
			40					50	50	50	50	50
								50	50	50		
									50	50		

S800S – S200L @230/400 V

Load s.	Char.	Supply s.		S800S								
		Icu [kA]	In [A]	B, C, D, K								
				50	25	32	40	50	63	80	100	125
S200L	C	6	6...8	50	50	50	50	50	50	50	50	50
			10	50	50	50	50	50	50	50	50	50
			13	50	50	50	50	50	50	50	50	50
			16	50	50	50	50	50	50	50	50	50
			20		50	50	50	50	50	50	50	50
			25			50	50	50	50	50	50	50
			32				50	50	50	50	50	50
			40					50	50	50	50	50

MCBs technical details

Coordination tables: back-up

S800S – S200M @230/400 V

Load s.	Char.	Supply s.		S800S								
		Icu [kA]	In [A]	B, C, D, K								
				50	25	32	40	50	63	80	100	125
S200M	B	15	6...16	50	50	50	50	50	50	50	50	50
			20		50	50	50	50	50	50	50	50
			25			50	50	50	50	50	50	50
			32				50	50	50	50	50	50
			40					50	50	50	50	50
			50						50	50	50	50
			63							50	50	50

Load s.	Char.	Supply s.		S800S								
		Icu [kA]	In [A]	B, C, D, K								
				50	25	32	40	50	63	80	100	125
S200M	C	15	0.5...16	50	50	50	50	50	50	50	50	50
			20		50	50	50	50	50	50	50	50
			25			50	50	50	50	50	50	50
			32				50	50	50	50	50	50
			40					50	50	50	50	50
			50						50	50	50	50
			63							50	50	50

S800S – S200P @230/400 V

Load s.	Char.	Supply s.		S800S								
		Icu [kA]	In [A]	B, C, D, K								
				50	25	32	40	50	63	80	100	125
S200P	B	25	6...16	50	50	50	50	50	50	50	50	50
			20		50	50	50	50	50	50	50	50
			25			50	50	50	50	50	50	50
		15	32				50	50	50	50	50	50
			40					50	50	50	50	50
			50						50	50	50	50
			63							50	50	50

Load s.	Char.	Supply s.		S800S								
		Icu [kA]	In [A]	B, C, D, K								
				50	25	32	40	50	63	80	100	125
S200P	C	25	0.5...16	50	50	50	50	50	50	50	50	50
			20		50	50	50	50	50	50	50	50
			25			50	50	50	50	50	50	50
		15	32				50	50	50	50	50	50
			40					50	50	50	50	50
			50						50	50	50	50
			63							50	50	50

MCBs technical details

Coordination tables: back-up

S800N – S200 @ 230/400V

Load s.	Char.	Supply s.		S800N								
		Icu [kA]	B, C, D									
			In [A]	25	32	40	50	63	80	100	125	
S200	B	10	6	36	36	36	36	36	36	36	36	36
			10	36	36	36	36	36	36	36	36	36
			13	36	36	36	36	36	36	36	36	36
			16	36	36	36	36	36	36	36	36	36
			20		36	36	36	36	36	36	36	36
			25			36	36	36	36	36	36	36
			32				36	36	36	36	36	36
			40					36	36	36	36	36
			50						36	36	36	36
			63							36	36	36

Load s.	Char.	Supply s.		S800N								
		Icu [kA]	B, C, D									
			In [A]	25	32	40	50	63	80	100	125	
S200	C	10	0.5...6	36	36	36	36	36	36	36	36	36
			8	36	36	36	36	36	36	36	36	36
			10	36	36	36	36	36	36	36	36	36
			13	36	36	36	36	36	36	36	36	36
			16	36	36	36	36	36	36	36	36	36
			20		36	36	36	36	36	36	36	36
			25			36	36	36	36	36	36	36
			32				36	36	36	36	36	36
			40					36	36	36	36	36
			50						36	36	36	36
63							36	36	36			

S800N – S200L @ 230/400V

Load s.	Char.	Supply s.		S800N								
		Icu [kA]	B, C, D									
			In [A]	25	32	40	50	63	80	100	125	
S200L	C	6	6...8	36	36	36	36	36	36	36	36	36
			10	36	36	36	36	36	36	36	36	
			13	36	36	36	36	36	36	36	36	
			16	36	36	36	36	36	36	36	36	
			20		36	36	36	36	36	36	36	
			25			36	36	36	36	36	36	
			32				36	36	36	36	36	
			40					36	36	36	36	

MCBs technical details

Coordination tables: back-up

S800N – S200M @ 230/400V

Load s.	Char.	Supply s.		S800N								
		Icu [kA]	In [A]	B, C, D								
				36	25	32	40	50	63	80	100	125
S200M	B	15	6...16	36	36	36	36	36	36	36	36	36
			20		36	36	36	36	36	36	36	36
			25			36	36	36	36	36	36	36
			32				36	36	36	36	36	36
			40					36	36	36	36	36
			50						36	36	36	36
			63							36	36	36

Load s.	Char.	Supply s.		S800N								
		Icu [kA]	In [A]	B, C, D								
				36	25	32	40	50	63	80	100	125
S200M	C	15	0.5...16	36	36	36	36	36	36	36	36	36
			20		36	36	36	36	36	36	36	36
			25			36	36	36	36	36	36	36
			32				36	36	36	36	36	36
			40					36	36	36	36	36
			50						36	36	36	36
			63							36	36	36

S800N – S200P @ 230/400V

Load s.	Char.	Supply s.		S800N								
		Icu [kA]	In [A]	B, C, D								
				36	25	32	40	50	63	80	100	125
S200P	B	25	6...16	36	36	36	36	36	36	36	36	36
			20		36	36	36	36	36	36	36	36
			25			36	36	36	36	36	36	36
		15	32				36	36	36	36	36	36
			40					36	36	36	36	36
			50						36	36	36	36
			63							36	36	36

Load s.	Char.	Supply s.		S800N								
		Icu [kA]	In [A]	B, C, D								
				36	25	32	40	50	63	80	100	125
S200P	C	25	0.5...16	36	36	36	36	36	36	36	36	36
			20		36	36	36	36	36	36	36	36
			25			36	36	36	36	36	36	36
		15	32				36	36	36	36	36	36
			40					36	36	36	36	36
			50						36	36	36	36
			63							36	36	36

MCBs technical details

Coordination tables: back-up

S800N – S400E @230/400V

Load s.	Char.	Supply s.		S800N								
		Icu [kA]	In [A]	B, C, D								
				36	25	32	40	50	63	80	100	125
S400E	B	Icn [kA] 6	6	36	36	36	36	36	36	36	36	36
			10	36	36	36	36	36	36	36	36	36
			13	36	36	36	36	36	36	36	36	36
			16	36	36	36	36	36	36	36	36	36
			20		36	36	36	36	36	36	36	36
			25			36	36	36	36	36	36	36
			32				36	36	36	36	36	36
			40					36	36	36	36	36
			50						36	36	36	36
			63							36	36	36

Load s.	Char.	Supply s.		S800N								
		Icu [kA]	In [A]	B, C, D								
				36	25	32	40	50	63	80	100	125
S400E	C	Icn [kA] 6	0.5...6	36	36	36	36	36	36	36	36	36
			8	36	36	36	36	36	36	36	36	36
			10	36	36	36	36	36	36	36	36	36
			13	36	36	36	36	36	36	36	36	36
			16	36	36	36	36	36	36	36	36	36
			20		36	36	36	36	36	36	36	36
			25			36	36	36	36	36	36	36
			32				36	36	36	36	36	36
			40					36	36	36	36	36
			50						36	36	36	36
63							36	36	36			

MCBs technical details

Coordination tables: back-up

S800N – S400M @230/400V

Load s.	Char.	Supply s.		S800N								
		Icu [kA]	In [A]	B, C, D								
				25	32	40	50	63	80	100	125	
S400M S450M FS401MB FS403MB	B, D	10	4*...16	36	36	36	36	36	36	36	36	36
			20		36	36	36	36	36	36	36	36
			25			36	36	36	36	36	36	36
			32				36	36	36	36	36	36
			40					36	36	36	36	36
			50						36	36	36	36
			63							36	36	36
											36	36

* for B characteristic only

Load s.	Char.	Supply s.		S800N								
		Icu [kA]	In [A]	B, C, D								
				25	32	40	50	63	80	100	125	
S400M S450M FS401MC FS403MC	C, K	10	0.5...2	36	36	36	36	36	36	36	36	36
		25	3...20	36	36	36	36	36	36	36	36	36
		15	25			36	36	36	36	36	36	36
			32				36	36	36	36	36	36
			40					36	36	36	36	36
			50						36	36	36	36
			63							36	36	36

S800N – S400M @254/440V

Load s.	Char.	Supply s.		S800N								
		Icu [kA]	In [A]	B, C, D								
				25	32	40	50	63	80	100	125	
S400M S450M	C, K	15	0.5...2	20	20	20	20	20	20	20	20	20
		10	3...10	20	20	20	20	20	20	20	20	20
		6	13	20	20	20	20	20	20	20	20	20
			16	20	20	20	20	20	20	20	20	20
			20		20	20	20	20	20	20	20	20
			25			20	20	20	20	20	20	20
			32				20	20	20	20	20	20
			40					20	20	20	20	20
			50						20	20	20	20
			63							20	20	20

MCBs technical details

Coordination tables: back-up

S800N – SN201 @ 230/240 V

Load s.	Char.	Supply s.		S800N								
		Icu [kA]	In [A]	B, C, D								
				36	25	32	40	50	63	80	100	125
SN201	B, D	10	6	36	36	36	36	36	36	36	36	36
			10	36	36	36	36	36	36	36	36	36
			16	36	36	36	36	36	36	36	36	36
			20		36	36	36	36	36	36	36	36
			25			36	36	36	36	36	36	36
			32				36	36	36	36	36	36
			40					36	36	36	36	36

S800N – SN201 @ 230/240 V

Load s.	Char.	Supply s.		S800N								
		Icu [kA]	In [A]	B, C, D								
				36	25	32	40	50	63	80	100	125
SN201	C	10	2	36	36	36	36	36	36	36	36	36
			4	36	36	36	36	36	36	36	36	36
			6	36	36	36	36	36	36	36	36	36
			10	36	36	36	36	36	36	36	36	36
			16	36	36	36	36	36	36	36	36	36
			20		36	36	36	36	36	36	36	36
			25			36	36	36	36	36	36	36
			32				36	36	36	36	36	36
			40					36	36	36	36	36

S800N – SN201L @ 230/240 V

Load s.	Char.	Supply s.		S800N								
		Icu [kA]	In [A]	B, C, D								
				36	25	32	40	50	63	80	100	125
SN201 L	B, C	6	2	36	36	25	25	18	15	15	15	
			4	36	36	25	25	18	15	15	15	
			6	36	36	25	25	18	15	15	15	
			10	36	36	25	25	18	15	15	15	
			16	36	36	25	25	18	15	15	15	
			20		36	25	25	18	15	15	15	
			25			25	25	18	15	15	15	
			32				25	18	15	15	15	
			40					18	15	15	15	

MCBs technical details

Coordination tables: back-up

S800N – SN201M @ 230/240 V

Load.s	Char.	Supply s.		S800N								
		Icu [kA]	In [A]	B, C, D								
				25	32	40	50	63	80	100	125	
SN201 M	B	10	6	36	36	36	36	36	36	36	36	36
			10	36	36	36	36	36	36	36	36	36
			16	36	36	36	36	36	36	36	36	36
			20		36	36	36	36	36	36	36	36
			25			36	36	36	36	36	36	36
			32				36	36	36	36	36	36
			40					36	36	36	36	36

S800N – SN201M @ 230/240 V

Load s.	Char.	Supply s.		S800N								
		Icu [kA]	In [A]	B, C, D								
				25	32	40	50	63	80	100	125	
SN201 M	C	10	2	36	36	36	36	36	36	36	36	36
			4	36	36	36	36	36	36	36	36	36
			6	36	36	36	36	36	36	36	36	36
			10	36	36	36	36	36	36	36	36	36
			16	36	36	36	36	36	36	36	36	36
			20		36	36	36	36	36	36	36	36
			25			36	36	36	36	36	36	36

S800C – S200 @ 230/400V

Load s.	Char.	Supply s.		S800C								
		Icu [kA]	In [A]	B, C, D								
				25	32	40	50	63	80	100	125	
S200	B	10	6	25	25	25	25	25	25	25	25	25
			10	25	25	25	25	25	25	25	25	25
			13	25	25	25	25	25	25	25	25	25
			16	25	25	25	25	25	25	25	25	25
			20		25	25	25	25	25	25	25	25
			25			25	25	25	25	25	25	25
			32				25	25	25	25	25	25
			40					25	25	25	25	25
			50						25	25	25	25
			63							25	25	25

MCBs technical details

Coordination tables: back-up

S800C – S200P @ 230/400V

Load s.	Char.	Supply s.		S800C								
		Icu [kA]	In [A]	B, C, D								
				25	25	32	40	50	63	80	100	125
S200P	B	25	6...16	25	25	25	25	25	25	25	25	25
			20		25	25	25	25	25	25	25	25
			25			25	25	25	25	25	25	25
		15	32				25	25	25	25	25	25
			40					25	25	25	25	25
			50						25	25	25	25
			63							25	25	25

Load s.	Char.	Supply s.		S800C								
		Icu [kA]	In [A]	B, C, D								
				25	25	32	40	50	63	80	100	125
S200P	C	25	0.5...16	25	25	25	25	25	25	25	25	25
			20		25	25	25	25	25	25	25	25
			25			25	25	25	25	25	25	25
		15	32				25	25	25	25	25	25
			40					25	25	25	25	25
			50						25	25	25	25
			63							25	25	25

S800C – SN201 @ 230/240 V

Load s.	Char.	Supply s.		S800C								
		Icu [kA]	In [A]	B, C, D, K								
				25	25	32	40	50	63	80	100	125
SN201	B, D	10	6	25	25	25	25	25	25	25	25	25
			10	25	25	25	25	25	25	25	25	25
			16	25	25	25	25	25	25	25	25	25
			20		25	25	25	25	25	25	25	25
			25			25	25	25	25	25	25	25
			32				25	25	25	25	25	25
			40					25	25	25	25	25

MCBs technical details

Coordination tables: back-up

S800C – SN201 @ 230/240 V

Load s.	Char.	Supply s.		S800C									
		Icu [kA]	In [A]	B, C, D, K									
				25	25	32	40	50	63	80	100	125	
SN201	C	10	2	25	25	25	25	25	25	25	25	25	25
			4	25	25	25	25	25	25	25	25	25	25
			6	25	25	25	25	25	25	25	25	25	25
			10	25	25	25	25	25	25	25	25	25	25
			16	25	25	25	25	25	25	25	25	25	25
			20		25	25	25	25	25	25	25	25	25
			25			25	25	25	25	25	25	25	25
			32				25	25	25	25	25	25	25
			40					25	25	25	25		

S800C – SN201L @ 230/240 V

Load s.	Char.	Supply s.		S800C								
		Icu [kA]	In [A]	B, C, D, K								
				25	25	32	40	50	63	80	100	125
SN201L	B, C	6	2	25	25	25	25	25	18	15	15	15
			4	25	25	25	25	25	18	15	15	15
			6	25	25	25	25	25	18	15	15	15
			10	25	25	25	25	25	18	15	15	15
			16	25	25	25	25	25	18	15	15	15
			20		25	25	25	25	18	15	15	15
			25			25	25	25	18	15	15	15
			32				25	25	18	15	15	15
			40				18	15	15	15		

S800C – SN201M @ 230/240 V

Load s.	Char.	Supply s.		S800C								
		Icu [kA]	In [A]	B, C, D, K								
				25	25	32	40	50	63	80	100	125
SN201M	B	10	6	25	25	25	25	25	25	25	25	25
			10	25	25	25	25	25	25	25	25	25
			16	25	25	25	25	25	25	25	25	25
			20		25	25	25	25	25	25	25	25
			25			25	25	25	25	25	25	25
			32				25	25	25	25	25	25
			40					25	25	25	25	25

MCBs technical details

Coordination tables: back-up

S800C – S400E @ 230/400V

Load s.	Char.	Supply s.		S800C								
		Icu [kA]	In [A]	B, C, D								
				25	25	32	40	50	63	80	100	125
S400E	B	Icn [kA] 6	6	25	25	25	25	25	25	25	25	25
			10	25	25	25	25	25	25	25	25	25
			13	25	25	25	25	25	25	25	25	25
			16	25	25	25	25	25	25	25	25	25
			20		25	25	25	25	25	25	25	25
			25			25	25	25	25	25	25	25
			32				25	25	25	25	25	25
			40					25	25	25	25	25
			50						25	25	25	25
			63							25	25	25

Load s.	Char.	Supply s.		S800C								
		Icu [kA]	In [A]	B, C, D								
				25	32	40	50	63	80	100	125	
S400E	C	Icn [kA] 6	0.5...6	25	25	25	25	25	25	25	25	25
			8	25	25	25	25	25	25	25	25	25
			10	25	25	25	25	25	25	25	25	25
			13	25	25	25	25	25	25	25	25	25
			16	25	25	25	25	25	25	25	25	25
			20		25	25	25	25	25	25	25	25
			25			25	25	25	25	25	25	25
			32				25	25	25	25	25	25
			40					25	25	25	25	25
			50						25	25	25	25
63							25	25	25			

MCBs technical details

Coordination tables: back-up

S800B – S200 @ 230/400V

Load s.	Char.	Supply s.		S800B							
		Icu [kA]	In [A]	B, C, D, K							
				32	40	50	63	80	100	125*	
S200	B	10	6	16	16	16	16	16	16	16	16
			10	16	16	16	16	16	16	16	16
			13	16	16	16	16	16	16	16	16
			16	16	16	16	16	16	16	16	16
			20	16	16	16	16	16	16	16	16
			25		16	16	16	16	16	16	16
			32			16	16	16	16	16	16
			40				16	16	16	16	16
			50					16	16	16	16
			63						16	16	16

Load s.	Char.	Supply s.		S800B							
		Icu [kA]	In [A]	B, C, D, K							
				32	40	50	63	80	100	125*	
S200	C, D, K, Z	10	0.5...6	16	16	16	16	16	16	16	16
			8	16	16	16	16	16	16	16	16
			10	16	16	16	16	16	16	16	16
			13	16	16	16	16	16	16	16	16
			16	16	16	16	16	16	16	16	16
			20	16	16	16	16	16	16	16	16
			25		16	16	16	16	16	16	16
			32			16	16	16	16	16	16
			40				16	16	16	16	16
			50					16	16	16	16
63						16	16	16			

* only S800B-B,C
back-up values indicated in kA

MCBs technical details

Coordination tables: back-up

S800B – S400E @230/400V

Load s.	Char.	Icu [kA]	Supply s.		S800B						
			B, C, D, K								
			In [A]	32	40	50	63	80	100	125	
S400E	B, C	6	6	16	16	16	16	16	16	16	16
			8	16	16	16	16	16	16	16	16
			10	16	16	16	16	16	16	16	16
			13	16	16	16	16	16	16	16	16
			16	16	16	16	16	16	16	16	16
			20	16	16	16	16	16	16	16	16
			25		16	16	16	16	16	16	16
			32			16	16	16	16	16	16
			40				16	16	16	16	16
			50					16	16	16	16
						16	16	16	16		
							16	16	16		

S800B – S400M @230/400V

Load s.	Char.	Icu [kA]	Supply s.		S800B						
			B, C, D, K								
			In [A]	32	40	50	63	80	100	125*	
S400M	B, D	10	6**	16	16	16	16	16	16	16	16
			8**	16	16	16	16	16	16	16	16
			10	16	16	16	16	16	16	16	16
			13	16	16	16	16	16	16	16	16
			16	16	16	16	16	16	16	16	16
			20	16	16	16	16	16	16	16	16
			25		16	16	16	16	16	16	16
			32			16	16	16	16	16	16
			40				16	16	16	16	16
			50					16	16	16	16
						16	16	16	16		

* only S800B-B, C

** only S400M-B

MCBs technical details

Coordination tables: back-up

Load s.	Char.	Supply s.		S800B							
		Icu [kA]	In [A]	B, C, D, K							
				32	40	50	63	80	100	125	
S400M	C	10	2	16	16	16	16	16	16	16	16
			3	16	16	16	16	16	16	16	16
			4	16	16	16	16	16	16	16	16
			6	16	16	16	16	16	16	16	16
			8	16	16	16	16	16	16	16	16
			10	16	16	16	16	16	16	16	16
			13	16	16	16	16	16	16	16	16
			16	16	16	16	16	16	16	16	16
			20	16	16	16	16	16	16	16	16
			25		16	16	16	16	16	16	16
			32			16	16	16	16	16	16
			40				16	16	16	16	16
50					16	16	16	16			
63						16	16	16			

Load s.	Char.	Supply s.		S800B							
		Icu [kA]	In [A]	B, C, D, K							
				32	40	50	63	80	100	125	
S400M	K	10	0.5...6	16	16	16	16	16	16	16	16
			8	16	16	16	16	16	16	16	16
			10	16	16	16	16	16	16	16	16
			13	16	16	16	16	16	16	16	16
			16	16	16	16	16	16	16	16	16
			20	16	16	16	16	16	16	16	16
			25		16	16	16	16	16	16	16
			32			16	16	16	16	16	16
			40				16	16	16	16	16
			50					16	16	16	16
			63						16	16	16

MCBs technical details

Coordination tables: back-up

S800B – S200M @ 230/400 V

Load s.	Char.	Supply s.		S800B							
		Icu [kA]	In [A]	B, C, D, K							
				32	40	50	63	80	100	125*	
S200M	B	15	6	16	16	16	16	16	16	16	16
			10	16	16	16	16	16	16	16	16
			13	16	16	16	16	16	16	16	16
			16	16	16	16	16	16	16	16	16
			20	16	16	16	16	16	16	16	16
			25		16	16	16	16	16	16	16
			32			16	16	16	16	16	16
			40				16	16	16	16	16
		10	50					16	16	16	16
			63						16	16	16

Load s.	Char.	Supply s.		S800B							
		Icu [kA]	In [A]	B, C, D, K							
				32	40	50	63	80	100	125*	
S200	C, D K, Z	15	0.5...6	16	16	16	16	16	16	16	16
			8	16	16	16	16	16	16	16	16
			10	16	16	16	16	16	16	16	16
			13	16	16	16	16	16	16	16	16
			16	16	16	16	16	16	16	16	16
			20	16	16	16	16	16	16	16	16
			25		16	16	16	16	16	16	16
			32			16	16	16	16	16	16
		10	40				16	16	16	16	16
			50					16	16	16	16
		63					16	16	16		

* only S800B-B,C

S800B – SN201 @ 230/240 V

Load s.	Char.	Supply s.		S800B							
		Icu [kA]	In [A]	B, C, D, K							
				32	40	50	63	80	100	125*	
SN201	B, D	10	6	16	16	16	16	16	16	16	16
			10	16	16	16	16	16	16	16	16
			16	16	16	16	16	16	16	16	16
			20	16	16	16	16	16	16	16	16
			25		16	16	16	16	16	16	16
			32			16	16	16	16	16	16
			40				16	16	16	16	16

MCBs technical details

Coordination tables: back-up

Load s.	Char.	Supply s.		S800B							
		Icu [kA]	In [A]	B, C, D, K							
				32	40	50	63	80	100	125*	
SN201	C	10	2	16	16	16	16	16	16	16	16
			4	16	16	16	16	16	16	16	16
			6	16	16	16	16	16	16	16	16
			10	16	16	16	16	16	16	16	16
			13	16	16	16	16	16	16	16	16
			16	16	16	16	16	16	16	16	16
			20	16	16	16	16	16	16	16	16
			25		16	16	16	16	16	16	16
			32			16	16	16	16	16	16
		40				16	16	16	16		

Load s.	Char.	Supply s.		S800B							
		Icu [kA]	In [A]	B, C, D, K							
				32	40	50	63	80	100	125*	
SN201 L	B, C	6	2	16	16	16	16	16	15	15	15
			4	16	16	16	16	16	15	15	15
			6	16	16	16	16	16	15	15	15
			10	16	16	16	16	16	15	15	15
			16	16	16	16	16	16	15	15	15
			20	16	16	16	16	16	15	15	15
			25		16	16	16	16	15	15	15
			32			16	16	16	15	15	15
			40					16	15	15	15

Load s.	Char.	Supply s.		S800B							
		Icu [kA]	In [A]	B, C, D, K							
				32	40	50	63	80	100	125*	
SN201 M	B	10	6	16	16	16	16	16	16	16	16
			10	16	16	16	16	16	16	16	16
			16	16	16	16	16	16	16	16	16
			20	16	16	16	16	16	16	16	16
			25		16	16	16	16	16	16	16
			32			16	16	16	16	16	16
			40					16	16	16	16

MCBs technical details

Coordination tables: back-up

Load s.	Char.	Supply s.		S800B								
		Icu [kA]	In [A]	B, C, D, K								
				32	40	50	63	80	100	125		
SN201 M	C	10	2	16	16	16	16	16	16	16	16	16
			4	16	16	16	16	16	16	16	16	16
			6	16	16	16	16	16	16	16	16	16
			10	16	16	16	16	16	16	16	16	16
			16	16	16	16	16	16	16	16	16	16
			20	16	16	16	16	16	16	16	16	16
			25		16	16	16	16	16	16	16	16
			32			16	16	16	16	16	16	16
			40				16	16	16	16	16	16

* only S800B-B,C
back-up values indicated in kA

S800U – S200 @ 230/400V

Load s.	Char.	Supply s.		S800U								
		Icu [kA]	In [A]	K, Z								
				50	25	32	40	50	63	80	100	125
S200	B	10	6	50	50	50	50	50	50	50	50	50
			10	50	50	50	50	50	50	50	50	50
			13	50	50	50	50	50	50	50	50	50
			16	50	50	50	50	50	50	50	50	50
			20		50	50	50	50	50	50	50	50
			25			50	50	50	50	50	50	50
			32				50	50	50	50	50	50
			40					50	50	50	50	50
			50						50	50	50	50
							50	50	50	50		

Load s.	Char.	Supply s.		S800U								
		Icu [kA]	In [A]	K, Z								
				50	25	32	40	50	63	80	100	125
S200	B	10	0.5...6	50	50	50	50	50	50	50	50	50
			8	50	50	50	50	50	50	50	50	50
			10	50	50	50	50	50	50	50	50	50
			13	50	50	50	50	50	50	50	50	50
			16	50	50	50	50	50	50	50	50	50
			20		50	50	50	50	50	50	50	50
			25			50	50	50	50	50	50	50
			32				50	50	50	50	50	50
			40					50	50	50	50	50
			50						50	50	50	50
			63							50	50	50

MCBs technical details

Coordination tables: back-up

S800U – S200M @ 230/400V

Load s.	Char.	Supply s.		S800U								
		Icu [kA]	In [A]	K, Z								
				25	32	40	50	63	80	100	125	
S200M	B	15	6...16	50	50	50	50	50	50	50	50	50
			20		50	50	50	50	50	50	50	50
			25			50	50	50	50	50	50	50
			32				50	50	50	50	50	50
			40					50	50	50	50	50
			50						50	50	50	50
			63							50	50	50

Load s.	Char.	Supply s.		S800U								
		Icu [kA]	In [A]	K, Z								
				25	32	40	50	63	80	100	125	
S200M	C	15	0.5...16	50	50	50	50	50	50	50	50	50
			20		50	50	50	50	50	50	50	50
			25			50	50	50	50	50	50	50
			32				50	50	50	50	50	50
			40					50	50	50	50	50
			50						50	50	50	50
			63							50	50	50

S800U – S200P @ 230/400V

Load s.	Char.	Supply s.		S800U								
		Icu [kA]	In [A]	K, Z								
				25	32	40	50	63	80	100	125	
S200P	B	25	6...16	50	50	50	50	50	50	50	50	50
			20		50	50	50	50	50	50	50	50
			25			50	50	50	50	50	50	50
		15	32				50	50	50	50	50	50
			40					50	50	50	50	50
			50						50	50	50	50
			63							50	50	50

MCBs technical details

Coordination tables: back-up

MCCB - MCB @ 415 V

Load s.	Carat.	In [A]	Supply s. Icu [kA]	XT1			XT2	XT3	XT4	XT1	XT2	XT3	XT4	XT1	XT2	XT4	XT2	XT4	XT2	XT4
				Version	B	C	N	S				H				L		V		
				18	25	36				50				70			120		150	
S200	B,C,K,Z	0,5..10 13..63	10	18	25	30	36	$\frac{36}{20}$	36	30	36	$\frac{40}{20}$	40	30	40	40	40	30	40	30
S200M	B,C,D,K,Z	0,5..10 13..63	15	18	25	30	36	$\frac{36}{25}$	36	30	50	$\frac{40}{25}$	40	30	50	40	$\frac{50}{50}$	30	$\frac{50}{50}$	30
S200P	B,C,D,K,Z	0,5..10	25			30	36	36	36	30	50	40	40	30	60	40	60	30	60	30
		13..25				30	36	30	36	30	50	30	40	30	50	40	50	30	50	30
		32..63	15	18	25	30	36	25	36	30	50	25	40	30	50	40	50	30	50	30
S800N	B,C,D	6..125	36						50	50	50	50	70	70	70	120	120	150	150	
S800S	B,C,D,K	6..125	50										70	70	70	120	120	150	150	
S800C	B,C,D,K	10..125				36	36	36	36	50	50	50	50	70	70	70	120	120	150	150

XT - S800B @ 230/400 V

Load s.	Char.	In [A]	Supply s. Icu [kA]	XT1	XT1	XT1	XT2	XT3	XT4	XT1	XT2	XT3	XT4	XT1	XT2	XT4	XT2	XT4	XT2	XT4
				Version	B	C	N	S				H				L		V		
				18	25	36				50				70			120		150	
S800B	B, C	32...100	16	18	25	36	36	36	36	50	50	50	50	70	70	70	120	120	150	150
	D, K	125*		18	25	36	36	36	36	50	50	50	50	70	70	70	120	120	150	150

MCBs technical details

Coordination tables: back-up

Breaking capacities

Definition: B and C acc. to IEC EN 60 898, Icn

K and Z acc. to IEC EN 60 947-2, Icu

Type Tripping characteristic Nominal current	AC				DC		Back up protection up to ultimate short-circuit capacity of short-circuit protective device.	
	1 phase		2/3 phases		1phase		Fuse	Selective MCB
	133 V~	230 V~	230 V~ 133/230 V~	400 V~ 230/400 V~	60 V $\overline{\text{---}}$	gG		
A	kA/cos ϕ	kA/cos ϕ	kA/cos ϕ	kA/cos ϕ	kA/T \leq ms			
S 200-B S 200 M-B	6						63 A	100 A
	10 ... 20						100 A	100 A
	25 ... 32	10/0,5	6/0,7 10/0,5 (S 200 M-B)	10/0,5	6/0,7 10/0,5 (S 200 M-B)	10/4,0	100 A	100 A
	40						125 A	100 A
	50 ... 63						160 A	100 A
S 200-C S 200 M-C	0,5 ... 2	100 kA					not required	
	3 ... 4						20 A	–
	6						40 A	100 A
	8						63 A	100 A
	10 ... 20	10/0,5	6/0,7 10/0,5 (S 200 M-C)	10/0,5	6/0,7 10/0,5 (S 200 M-C)	10/4,0	100 A	100 A
	25 ... 32						100 A	100 A
S 200-K S 200 M-K	40						125 A	100 A
	50 ... 63						160 A	100 A
	0,5 ... 2	100 kA					not required	
	3						20 A	–
	4						25 A	–
	6 ... 10						63 A	100 A
S 200-Z S 200 M-Z	16 ... 20	10/0,5	6/0,7 10/0,5 (S 200 M-K)	10/0,5	6/0,7 10/0,5 (S 200 M-K)	10/4,0	80 A	100 A
	25 ... 32						100 A	100 A
	40						125 A	100 A
	50 ... 63						160 A	100 A
	0,5 ... 2	100 kA					not required	
	3 ... 4						20 A	–
S 200-Z S 200 M-Z	6						35 A	100 A
	8						40 A	100 A
	10 ... 16	10/0,5	6/0,7 10/0,5 (S 200 M-Z)	10/0,5	6/0,7 10/0,5 (S 200 M-Z)	10/4,0	63 A	100 A
	20 ... 25						80 A	100 A
	32 ... 40						100 A	100 A
	50 ... 63						125 A	100 A

1. In symmetrically earthed DC networks 2 pole MCBs can be applied at up to 125 V DC (series connection). In this case the breaking capacity is one level higher compared to an equivalent 1 pole installation. Polarity does not have to be considered. Thus any connection mode is permitted.

2. Back up protection is only required when the prospective short circuit current exceeds the rated breaking capacity.

MCBs technical details

Coordination tables: back-up

Breaking capacities

Definition: B and C acc. to IEC EN 60 898, Icn

K and Z acc. to IEC EN 60 947-2, Icu

Type Tripping characteristic Nominal current	AC				DC		Back up protection up to ultimate short-circuit capacity of short-circuit protective device.	
	1 phase		2/3 phases		1phase			
	133 V~	230 V~	230 V~ 133/230 V~	400 V~ 230/400 V~	60 V $\overline{\text{---}}$	Fuse	Selective MCB	
A	kA/cosj	kA/cosj	kA/cosj	kA/cosj	kA/T ≤ ms	gG	S 750 DR	
S 200 P-B	6				10/4,0	63 A	100 A	
	10, 13	25/0,25	25/0,25	25/0,25	25/0,25	80 A	100 A	
	16 ... 25				15/4,0	100 A	100 A	
	32 ... 40					125 A	100 A	
	50 ... 63	15/0,25	15/0,25	15/0,25	15/0,25	10/4,0	160 A	100 A
S 200 P-C	0,5 ... 2	100 kA					not required	
	3, 4					32 A	100 A	
	6, 8				10/4,0	63 A	100 A	
	10 ... 13	25/0,25	25/0,25	25/0,25	25/0,25	80 A	100 A	
	16 ... 25				15/4,0	100 A	100 A	
	32 ... 40					125 A	100 A	
S 200 P-K, Z	0,5 ... 2	100 kA					not required	
	3					25 A	-	
	4				10/4,0	35 A	-	
	6	25/0,25	25/0,25	25/0,25	25/0,25	63 A	100 A	
	8					80 A	100 A	
	10 ... 20				15/4,0	100 A	100 A	
	25				15/4,0	125 A	100 A	
	32 ... 63	15/0,25	15/0,25	15/0,25	15/0,25	10/4,0	160 A	100 A

1. In symmetrically earthed DC networks 2 pole MCBs can be applied at up to 125 V DC (series connection). Polarity does not have to be considered. Thus any connection mode is permitted.

2. Back up protection is only required when the prospective short circuit current exceeds the rated breaking capacity.

MCBs technical details

Coordination tables: back-up

Fuse gG - MCB S 200, S 200 M

240 V		Supply s.	Fuse gG		S 750 DR
Load s.	Characteristic	In [A]	In [A]	In [A]	
S200 S200 M	B	6	63	100	
		10...20	100	100	
		25...32	100	100	
		40	125	100	
		50...63	160	100	
S200 S200 M	C	3...4	20	—	
		6	40	100	
		8	63	100	
		10...20	100	100	
		25...32	100	100	
		40	125	100	
		50...63	160	100	
S200	K	3	20	—	
		4	25	—	
		6...10	63	100	
		16...20	80	100	
		25...32	100	100	
		40	125	100	
		50...63	160	100	
S200	Z	3...4	20	—	
		6	35	100	
		8	40	100	
		10...16	63	100	
		20...25	80	100	
		32...40	100	100	
		50...63	125	100	

This table shows coordination between an MCB and the upstream fuse maximum current value. Combination of the two protections allows the breaking capacity to be elevated up to that of the combined fuse.

I.e. downstream MCB breaker S 201-C16, upstream fuse with In up to 100 A (breaking capacity: 100 kA). MCB breaker protection up to 100 kA.

MCBs technical details

Coordination tables: back-up

Fuse gG - MCB S 200 P

240 V	Supply s.	Fuse gG		S 750 DR
Load s.	Characteristic	In [A]	In [A]	In [A]
S200 P	B	6	63	100
		10, 13	80	100
		16...25	100	100
		32...40	125	100
		50...63	160	100
S200 P	C	3, 4	40	100
		6, 8	63	100
		10, 13	100	100
		16...25	100	100
		32...40	125	100
		50...63	160	100
S200 P	K, Z	3	25	—
		4	35	—
		6	63	100
		8	80	100
		10...20	100	100
		25	125	100
		32...63	160	100

This table shows coordination between an MCB and the upstream fuse maximum current value. Combination of the two protections allows the breaking capacity to be elevated up to that of the combined fuse.

I.e. downstream MCB breaker S 201-C16, upstream fuse with In up to 100 A (breaking capacity: 100 kA). MCB breaker protection up to 100 kA.

MCBs technical details

Coordination tables: selectivity

Selective protection

Selectivity between SN 201 and S 200 upstream and downstream modular circuit-breakers
In the case, selectivity is amperometric and so the selectivity

limit is given simply by the magnetic threshold of the upstream breaker, which is fixed. The selectivity value is obtained if a minimum ratio of 1.3 ($I_n \text{ upstream} / I_n \text{ downstream} > 1.3$) is observed between the rated currents of the two breakers.

MCB - SN201 @ 230/240 V

Supply S.2		S800 N-S										
Load S.1	Char.	Icu [kA]	B									
			36-50									
			In [A]	25	32	40	50	63	80	100	125	
SN201 L	B, C	6	2		0.433	0.6	1.3	4	T	T	T	
			4			0.45	0.8	1.5	2.5	4	T	
			6				0.6	1.2	1.6	2.6	3.8	
			10				0.5	1.1	1.4	2	3	
			16					0.8	1.2	1.7	2.5	
			20						1	1.5	2.1	
			25							1.3	1.8	
			32								1.1	1.7
			40									1.6
SN201	B, C, D	10	2		0.433	0.6	1.3	4	9	T	T	
			4			0.45	0.8	1.5	2.5	4	7.3	
			6				0.6	1.2	1.6	2.6	3.8	
			10				0.5	1.1	1.4	2	3	
			16					0.8	1.2	1.7	2.5	
			20						1	1.5	2.1	
			25							1.3	1.8	
			32								1.1	1.7
			40									1.6
SN201 M	B, C	10	2		0.433	0.6	1.3	4	9	T	T	
			4			0.45	0.8	1.5	2.5	4	7.3	
			6				0.6	1.2	1.6	2.6	3.8	
			10				0.5	1.1	1.4	2	3	
			16					0.8	1.2	1.7	2.5	
			20						1	1.5	2.1	
			25							1.3	1.8	
			32								1.1	1.7
			40									1.6

¹ Load side circuit-breaker 1P+N (230/240 V)

² For networks with 230/240 V AC ⇒ two-pole circuit-breaker (phase + neutral)

for networks at 400/415 V AC ⇒ four-pole circuit-breaker (load side circuit branched between one phase and the neutral)

³ Only for curve B

MCBs technical details

Coordination tables: selectivity

Example

Upstream circuit-breaker	S 200 P, curve D 50 A
Downstream circuit-breaker	SN 201 L, curve B 10 A
Selectivity limit	10 I _n =500 A

S800 N-S								S800 N-S							
C								D							
36-50								36-50							
25	32	40	50	63	80	100	125	25	32	40	50	63	80	100	125
0.43	0.55	1.2	3	T	T	T	T	1.3	4.1	T	T	T	T	T	T
	0.43	0.75	1.3	2.1	3.9	T	T	0.8	1.6	3	5.4	T	T	T	T
		0.55	1.1	1.5	2.5	3.6	5.5	0.6	1.3	2	3.2	3.9	T	T	T
		0.45	1	1.3	1.9	2.8	4.2	0.5	1.2	1.65	2.6	3.1	T	T	T
			0.75	1.1	1.6	2.3	3.6		0.9	1.4	1.8	2.6	5	T	T
				0.9	1.4	1.9	3.3			1.3	1.6	2.2	4.2	5.4	T
					1.2	1.6	2.7				1.5	1.9	3.5	4.5	T
					1	1.5	2.5					1.8	2.8	4.2	5.5
						1.4	2.1					1.7	2.7	4	5
0.43	0.55	1.2	3	6.6	T	T	T	1.3	4.1	T	T	T	T	T	T
	0.43	0.75	1.3	2.1	3.9	6.6	T	0.8	1.6	3	5.4	7.6	T	T	T
		0.55	1.1	1.5	2.5	3.6	5.5	0.6	1.3	2	3.2	3.9	8	T	T
		0.45	1	1.3	1.9	2.8	4.2	0.5	1.2	1.65	2.6	3.1	6.2	8.6	T
			0.75	1.1	1.6	2.3	3.6		0.9	1.4	1.8	2.6	5	6.3	8.8
				0.9	1.4	1.9	3.3			1.3	1.6	2.2	4.2	5.4	7.6
					1.2	1.6	2.7				1.5	1.9	3.5	4.5	6.6
					1	1.5	2.5					1.8	2.8	4.2	5.5
						1.4	2.1					1.7	2.7	4	5
0.43	0.55	1.2	3	6.6	T	T	T	1.3	4.1	T	T	T	T	T	T
	0.43	0.75	1.3	2.1	3.9	6.6	T	0.8	1.6	3	5.4	7.6	T	T	T
		0.55	1.1	1.5	2.5	3.6	5.5	0.6	1.3	2	3.2	3.9	8	T	T
		0.45	1	1.3	1.9	2.8	4.2	0.5	1.2	1.65	2.6	3.1	6.2	8.6	T
			0.75	1.1	1.6	2.3	3.6		0.9	1.4	1.8	2.6	5	6.3	8.8
				0.9	1.4	1.9	3.3			1.3	1.6	2.2	4.2	5.4	7.6
					1.2	1.6	2.7				1.5	1.9	3.5	4.5	6.6
					1	1.5	2.5					1.8	2.8	4.2	5.5
						1.4	2.1					1.7	2.7	4	5

MCBs technical details

Coordination tables: selectivity

Fuse - SN201 @ 230/240 V

	Im	Icu [kA]	In [A]								
			25	32	40	50	63	80	100	125	
SN201 L	B-C	6	2	1.5	2.5	T	T	T	T	T	T
		6	4	1	2	4.5	T	T	T	T	T
		6	6	1	1.5	4	4.5	T	T	T	T
		6	10		1.2	3.5	4	T	T	T	T
		6	16		1	3	3.5	5	T	T	T
		6	20		1	3	3.5	5	T	T	T
		6	25		1	2	3	4.5	T	T	T
		6	32		1	2	3	4.5	5	T	T
		6	40			1.5	2.5	4	5	T	T
SN201	B-C-D	10	2	1.5	2.5	5	T	T	T	T	T
		10	4	1	2	4.5	5	T	T	T	T
		10	6	1	1.5	4	4.5	7	T	T	T
		10	10		1.2	3.5	4	6	T	T	T
		10	16		1	3	3.5	5	T	T	T
		10	20		1	3	3.5	5	8	T	T
		10	25		1	2	3	4.5	6.5	T	T
		10	32		1	2	3	4.5	5	8	T
		10	40			1.5	2.5	4	5	6.5	T
SN201 M	B-C	10	2	1.5	2.5	5	7	T	T	T	T
		10	4	1	2	4.5	5	8	T	T	T
		10	6	1	1.5	4	4.5	7	T	T	T
		10	10		1.2	3.5	4	6	T	T	T
		10	16		1	3	3.5	5	9	T	T
		10	20		1	3	3.5	5	8	T	T
		10	25		1	2	3	4.5	6.5	9	T
		10	32		1	2	3	4.5	5	8	T
		10	40			1.5	2.5	4	5	6.5	9

MCBs technical details

Coordination tables: selectivity

MCB S 759 DR - SN201 @ 230/240 V

	Im	Icu [kA]	E											
			25		25		25		25		25		25	
			In [A]	20	25	32	40	50	63	80	100			
SN201 L	B-C	6	2	T	T	T	T	T	T	T	T	T		
		6	4	T	T	T	T	T	T	T	T	T		
		6	6	T	T	T	T	T	T	T	T	T		
		6	10	T	T	T	T	T	T	T	T	T		
		6	16		T	T	T	T	T	T	T	T		
		6	20			T	T	T	T	T	T	T		
		6	25				T	T	T	T	T	T		
		6	32					T	T	T	T	T		
		6	40						T	T	T	T		
SN201	B-C-D	10	2	T	T	T	T	T	T	T	T	T		
		10	4	T	T	T	T	T	T	T	T	T		
		10	6	T	T	T	T	T	T	T	T	T		
		10	10	T	T	T	T	T	T	T	T	T		
		10	16		T	T	T	T	T	T	T	T		
		10	20			T	T	T	T	T	T	T		
		10	25				T	T	T	T	T	T		
		10	32					T	T	T	T	T		
		10	40						T	T	T	T		
SN201 M	B-C	10	2	T	T	T	T	T	T	T	T	T		
		10	4	T	T	T	T	T	T	T	T	T		
		10	6	T	T	T	T	T	T	T	T	T		
		10	10	T	T	T	T	T	T	T	T	T		
		10	16		T	T	T	T	T	T	T	T		
		10	20			T	T	T	T	T	T	T		
		10	25				T	T	T	T	T	T		
		10	32					T	T	T	T	T		
		10	40						T	T	T	T		

MCBs technical details

Coordination tables: selectivity

MCCB XT1@415V - SN201 @230/240V

			Supply S.	XT1											
			Version	B,C,N,S,H											
			Release	TM											
Load S.	Char	Icu [kA]	In[A]	16	20	25	32	40	50	63	80	100	125	160	
SN201 L	B,C	6	≤ 4	T	T	T	T	T	T	T	T	T	T	T	T
			6	T	T	T	T	T	T	T	T	T	T	T	T
			10			3	3	3	4,5	T	T	T	T	T	T
			16					3	4,5	5	T	T	T	T	T
			20						3	5	T	T	T	T	T
			25							5	T	T	T	T	T
			32									T	T	T	T
			40											T	T
SN201	B,C,D,K	10	≤ 4	T	T	T	T	T	T	T	T	T	T	T	T
			6	6	6	6	6	6	6	T	T	T	T	T	
			8			3	3	3	4,5	7,5	8,5	T	T	T	
			10			3	3	3	4,5	7,5	8,5	T	T	T	
			13					3	4,5	5	7,5	T	T	T	
			16					3	4,5	5	7,5	T	T	T	
			20						3	5	6	T	T	T	
			25							5	6	T	T	T	
			32								6	7,5	T	T	
			40									7,5	T	T	
SN201 M	B,C	10	≤ 4	T	T	T	T	T	T	T	T	T	T	T	T
			6	6	6	6	6	6	6	T	T	T	T	T	
			10			3	3	3	4,5	7,5	8,5	T	T	T	
			13					3	4,5	5	7,5	T	T	T	
			16					3	4,5	5	7,5	T	T	T	
			20						3	5	6	T	T	T	
			25							5	6	T	T	T	
			32								6	7,5	T	T	
			40									7,5	T	T	

MCBs technical details

Coordination tables: selectivity

MCCB XT2@415V - SN201 @230/240V

Load S.	Char	Icu [kA]	Supply S.	XT2																
			Version	N,S,H,L,V																
			Release	TM												EL				
			In[A]	16	20	25	32	40	50	63	80	100	125	160	10	25	63	100	160	
SN201 L	B,C	6	≤ 4	T	T	T	T	T	T	T	T	T	T	T	T	T	T	T	T	
			6	T	T	T	T	T	T	T	T	T	T	T		T	T	T	T	
			10		3 ①	3	3	3	4,5	T	T	T	T	T		T	T	T	T	
			16				3 ①	3	4,5	5	T	T	T	T			T	T	T	
			20				3 ①		3	5	T	T	T	T			T	T	T	
			25						3 ①	5	T	T	T	T			T	T	T	
			32							3 ①		T	T	T	T			T	T	T
			40									T	T	T	T				T	T
SN201	B,C,D,K	10	≤ 4	T	T	T	T	T	T	T	T	T	T	T	T	T	T	T	T	
			6	T	T	T	T	T	T	T	T	T	T	T		T	T	T	T	
			8		3 ①	3	3	3	4,5	7,5	8,5	T	T	T		T	T	T	T	
			10		3 ①	3	3	3	4,5	7,5	8,5	T	T	T		T	T	T	T	
			13				3 ①	3	4,5	5	7,5	T	T	T			T	T	T	
			16				3 ①	3	4,5	5	7,5	T	T	T			T	T	T	
			20				3 ①		3	5	6	T	T	T			T	T	T	
			25						3 ①	5	6	T	T	T			T	T	T	
			32							3 ①		6	7,5	T	T			T	T	T
			40									6,1	7,5	T	T				T	T
SN201 M	B,C	10	≤ 4	T	T	T	T	T	T	T	T	T	T	T	T	T	T	T	T	
			6	T	T	T	T	T	T	T	T	T	T	T		T	T	T	T	
			10		3 ①	3	3	3	4,5	7,5	8,5	T	T	T		T	T	T	T	
			13				3 ①	3	4,5	5	7,5	T	T	T			T	T	T	
			16				3 ①	3	4,5	5	7,5	T	T	T			T	T	T	
			20				3 ①		3	5	6	T	T	T			T	T	T	
			25						3 ①	5	6	T	T	T			T	T	T	
			32							3 ①		6	7,5	T	T			T	T	T
			40									6,1	7,5	T	T				T	T

① Value valid in case of Supply S. breaker only magnetic

MCBs technical details

Coordination tables: selectivity

MCCB XT4@415V - SN201 @230/240V

		Supply S.	XT4																				
		Version	N,S,H,L,V																				
		Release	TM															EL					
Load S.	Char	Icu [kA]	In[A]	20	25	32	40	50	63	80	100	125	160	200	225	250	40	63	100	160	250		
SN201 L	B,C	6	≤ 4	T	T	T	T	T	T	T	T	T	T	T	T	T	T	T	T	T	T	T	
			6	T	T	T	T	T	T	T	T	T	T	T	T	T	T	T	T	T	T	T	T
			10	3①	3	3	3	4,5	T	T	T	T	T	T	T	T	T	3	T	T	T	T	T
			16			3①	3	4,5	5	T	T	T	T	T	T	T	T	3	T	T	T	T	T
			20			3①		3	5	T	T	T	T	T	T	T	T		T	T	T	T	T
			25					3①	5	T	T	T	T	T	T	T	T		T	T	T	T	T
			32					3①		T	T	T	T	T	T	T	T		T	T	T	T	T
			40							T	T	T	T	T	T	T	T				T	T	T
SN201	B,C,D,K	10	≤ 4	T	T	T	T	T	T	T	T	T	T	T	T	T	T	T	T	T	T	T	
			6	T	T	T	T	T	T	T	T	T	T	T	T	T	T	T	T	T	T	T	T
			8	3	1	3	3	3	4,5	7,5	8,5	T	T	T	T	T	T	3	T	T	T	T	T
			10	3①	3	3	3	4,5	7,5	8,5	T	T	T	T	T	T	T	3	T	T	T	T	T
			13			3①	3	4,5	5	7,5	T	T	T	T	T	T	T	3	T	T	T	T	T
			16			3①	3	4,5	5	7,5	T	T	T	T	T	T	T	3	T	T	T	T	T
			20			3①		3	5	6	T	T	T	T	T	T	T		T	T	T	T	T
			25					3①	5	6	T	T	T	T	T	T	T		T	T	T	T	T
SN201 M	B,C	10	≤ 4	T	T	T	T	T	T	T	T	T	T	T	T	T	T	T	T	T	T	T	
			6	T	T	T	T	T	T	T	T	T	T	T	T	T	T	T	T	T	T	T	T
			10	3①	3	3	3	4,5	7,5	8,5	T	T	T	T	T	T	T	3	T	T	T	T	T
			13			3①	3	4,5	5	7,5	T	T	T	T	T	T	T	3	T	T	T	T	T
			16			3①	3	4,5	5	7,5	T	T	T	T	T	T	T	3	T	T	T	T	T
			20			3①		3	5	6	T	T	T	T	T	T	T		T	T	T	T	T
			25					3①	5	6	T	T	T	T	T	T	T		T	T	T	T	T
			32					3①		6	7,5	T	T	T	T	T	T		T	T	T	T	T
40							6①	7,5	T	T	T	T	T	T				T	T	T			

① Value valid in case of Supply S. breaker only magnetic

Tmax T3 – S800S @400/415V

		Supply s.	T3							
		Char.	N, S							
		Trigger	TM							
Load s.		Icu [kA]	Iu [A]	250						
			In [A]	63	80	100	125	160	200	250
S800S	B, C, D, K	50	10	8	10	20	25	36	36	50*
			13	7.5	10	15	25	36	36	50*
			16	7.5	10	15	25	36	36	50*
			20	7.5	10	15	25	36	36	50*
			25	6	10	15	20	36	36	50*
			32		7.5	10	20	36	36	50*
			40			10	20	36	36	50*
			50				15	36	36	50*
			63					36	36	50*
			80						36	50*
			100							50*
125							50*			

MCBs technical details

Coordination tables: selectivity

S800S - S200 @ 230/400 V

		E.		S800S							
		Char.		B							
L.		Icu [kA]	50								
			In [A]	25	32	40	50	63	80	100	125
S200	B	10	6			0.4	0.5	0.7	1	1.5	2.6
			10				0.4	0.6	0.7	1	1.4
			13					0.5	0.7	0.9	1.3
			16						0.7	0.9	1.3
			20							0.9	1.3
			25							0.9	1.3
			32							0.8	1.1
			40							0.8	1.1
			50								1
			63								

		E.		S800S								
		Char.		B								
L.		Icu [kA]	50									
			In [A]	25	32	40	50	63	80	100	125	
S200	C	10	0.5	T	T	T	T	T	T	T	T	T
			1	3.3	T	T	T	T	T	T	T	T
			1.6	0.6	1.3	T	T	T	T	T	T	T
			2	0.4	0.7	1.3	T	T	T	T	T	T
			3		0.4	0.6	0.7	1.1	2.6	T	T	
			4		0.4	0.6	0.7	1	1.7	3.1	T	
			6			0.4	0.5	0.7	1	1.5	2.6	
			8				0.4	0.6	0.7	1	1.4	
			10				0.4	0.6	0.7	1	1.4	
			13					0.5	0.7	0.9	1.3	
			16						0.7	0.9	1.3	
			20							0.9	1.3	
			25							0.9	1.3	
			32							0.8	1.1	
			40							0.8	1.1	
			50								1	
			63									0.9

E. = feed side

L. = load side

T = Total selectivity up to breaking capacity of the switch on load side

Selectivity limit values indicated in kA

MCBs technical details

Coordination tables: selectivity

		E. S800S	
		B	
L.	Char.	Icu [kA]	50
		In [A]	25 32 40 50 63 80 100 125
S200	D	10	0.5 T T T T T T T T T
			1 0.8 4.5 T T T T T T T
			1.6 0.5 1 2.3 T T T T T T
			2 0.3 0.5 0.7 2.3 T T T T T
			3 0.4 0.5 0.7 1.2 2.5 T T
			4 0.4 0.4 0.7 1 1.7 3 T
			6 0.6 0.8 1.2 2 3.6
			8 0.7 0.9 1.3 2
			10 0.9 1.3 2
			13 1 1.5
			16 1.5
			20
			25
			32
			40
50			
63			

		E. S800S	
		B	
L.	Char.	Icu [kA]	50
		In [A]	25 32 40 50 63 80 100 125
S200	K	10	0.5 T T T T T T T T T
			1 0.8 5 T T T T T T T
			1.6 0.5 1 2.1 T T T T T T
			2 0.3 0.5 0.7 2.1 T T T T T
			3 0.4 0.5 0.7 1.2 2.5 T T
			4 0.4 0.4 0.7 1 1.7 3 T
			6 0.6 0.8 1.2 2 3.6
			8 0.7 0.9 1.3 2
			10 0.9 1.3 2
			13 1 1.5
			16 1.5
			20
			25
			32
			40
50			
63			

E. = feed side

L. = load side

T = Total selectivity up to breaking capacity of the switch on load side

Selectivity limit values indicated in kA

MCBs technical details

Coordination tables: selectivity

		E. S800S									
		C									
L.	Char.	Icu [kA]	50								
			In [A]	25	32	40	50	63	80	100	125
S200	B	10	6		0.4	0.5	0.7	0.9	1.4	2.4	4.8
			10		0.3	0.4	0.5	0.7	0.9	1.3	2
			13		0.3	0.4	0.5	0.7	0.9	1.3	1.9
			16		0.3	0.4	0.5	0.7	0.9	1.3	1.9
			20			0.4	0.5	0.7	0.9	1.2	1.8
			25			0.4	0.5	0.7	0.9	1.2	1.8
			32				0.5	0.6	0.8	1	1.4
			40					0.6	0.8	1	1.4
			50						0.7	0.9	1.3
			63							0.9	1.2

		E. S800S										
		C										
L.	Char.	Icu [kA]	50									
			In [A]	25	32	40	50	63	80	100	125	
S200	C	10	0.5	T	T	T	T	T	T	T	T	T
			1	T	T	T	T	T	T	T	T	T
			1.6	0.6	T	T	T	T	T	T	T	T
			2	0.5	1	T	T	T	T	T	T	T
			3	0.3	0.5	0.7	1.2	2.1	T	T	T	T
			4	0.3	0.4	0.7	1	1.5	2.6	T	T	T
			6		0.4	0.5	0.7	0.9	1.4	2.4	4.8	
			8		0.3	0.4	0.5	0.7	0.9	1.3	2	
			10		0.3	0.4	0.5	0.7	0.9	1.3	2	
			13		0.3	0.4	0.5	0.7	0.9	1.3	1.9	
			16		0.3	0.4	0.5	0.7	0.9	1.3	1.9	
			20			0.4	0.5	0.7	0.9	1.2	1.8	
			25			0.4	0.5	0.7	0.9	1.2	1.8	
			32				0.5	0.6	0.8	1	1.4	
			40					0.6	0.8	1	1.4	
			50						0.7	0.9	1.3	
			63							0.9	1.2	

E. = feed side

L. = load side

T = Total selectivity up to breaking capacity of the switch on load side

Selectivity limit values indicated in kA

MCBs technical details

Coordination tables: selectivity

		E. S800S									
		C									
L.	Char.	Icu [kA]	50								
		In [A]	25	32	40	50	63	80	100	125	
S200	D	10	0.5	T	T	T	T	T	T	T	T
			1	2.1	T	T	T	T	T	T	T
			1.6	0.8	2.3	T	T	T	T	T	T
			2	0.4	0.7	2.3	T	T	T	T	T
			3	0.3	0.5	0.7	1.2	2.2	T	T	T
			4	0.3	0.4	0.7	1	1.4	2.6	T	T
			6		0.4	0.6	0.8	1.1	1.8	3.2	T
			8			0.5	0.7	0.9	1.2	1.8	2.8
			10				0.7	0.9	1.2	1.8	2.8
			13					0.7	1	1.4	2
			16						1	1.4	2
			20							1	1.4
			25								1.4
			32								

		E. S800S									
		C									
L.	Char.	Icu [kA]	50								
		In [A]	25	32	40	50	63	80	100	125	
S200	K	10	0.5	T	T	T	T	T	T	T	T
			1	2.1	T	T	T	T	T	T	T
			1.6	0.8	2.3	T	T	T	T	T	T
			2	0.4	0.7	2.3	T	T	T	T	T
			3	0.3	0.5	0.7	1.2	2.2	T	T	T
			4	0.3	0.4	0.7	1	1.4	2.6	T	T
			6		0.4	0.6	0.8	1.1	1.8	3.2	T
			8			0.5	0.7	0.9	1.2	1.8	2.8
			10				0.7	0.9	1.2	1.8	2.8
			13					0.7	1	1.4	2
			16						1	1.4	2
			20							1	1.4
			25								1.4
			32								

E. = feed side

L. = load side

T = Total selectivity up to breaking capacity of the switch on load side

Selectivity limit values indicated in kA

MCBs technical details

Coordination tables: selectivity

		E. S800S									
		Char: D									
L.		Icu [kA]	50								
			In [A]	25	32	40	50	63	80	100	125
S200	B	10	6	0.5	1	1.2	2	2.8	T	T	T
			10	0.4	0.6	0.8	1.1	1.4	2.8	3.9	T
			13	0.4	0.6	0.8	1.1	1.4	2.5	3.3	T
			16		0.6	0.8	1.1	1.4	2.5	3.3	5.6
			20			0.8	1.1	1.3	2.3	3	4.7
			25			0.8	1.1	1.3	2.3	3	4.7
			32				0.9	1.1	1.9	2.4	3.7
			40					1.1	1.9	2.4	3.7
			50						1.5	1.9	2.3
			63							1.7	2.3

		E. S800S										
		Char: D										
L.		Icu [kA]	50									
			In [A]	25	32	40	50	63	80	100	125	
S200	C	10	0.5	T	T	T	T	T	T	T	T	T
			1	T	T	T	T	T	T	T	T	T
			1.6	T	T	T	T	T	T	T	T	T
			2	T	T	T	T	T	T	T	T	T
			3	0.7	2.2	4.4	T	T	T	T	T	
			4	0.7	1.3	2.2	4.4	T	T	T	T	
			6	0.5	1	1.2	2	2.8	T	T	T	
			8	0.4	0.6	0.8	1.1	1.4	2.8	3.9	T	
			10	0.4	0.6	0.8	1.1	1.4	2.8	3.9	T	
			13	0.4	0.6	0.8	1.1	1.4	2.5	3.3	5.6	
			16		0.6	0.8	1.1	1.4	2.5	3.3	5.6	
			20			0.8	1.1	1.3	2.3	3	4.7	
			25			0.8	1.1	1.3	2.3	3	4.7	
			32				0.9	1.1	1.9	2.4	3.7	
			40					1.1	1.9	2.4	3.7	
			50						1.5	1.9	2.3	
63							1.7	2.3				

E. = feed side

L. = load side

T = Total selectivity up to breaking capacity of the switch on load side

Selectivity limit values indicated in kA

MCBs technical details

Coordination tables: selectivity

		E. S800S									
Char:		D									
L.	Icu [kA]	50									
	In [A]	25	32	40	50	63	80	100	125		
S200	D	10	0.5	T	T	T	T	T	T	T	T
			1	T	T	T	T	T	T	T	T
			1.6	T	T	T	T	T	T	T	T
			2	2.3	T	T	T	T	T	T	T
			3	0.7	1.3	4.4	T	T	T	T	T
			4	0.7	1	2.2	4.4	T	T	T	T
			6	0.6	0.8	1.5	2.5	3.6	T	T	T
			8	0.5	0.7	1.1	1.5	2	4	5.5	T
			10	0.5	0.7	1.1	1.5	2	4	5.5	T
			13		0.6	0.9	1.2	1.5	2.6	3.4	5.2
			16			0.9	1.2	1.5	2.6	3.4	5.2
			20				0.9	1.1	1.8	2.2	3.2
			25					1.1	1.8	2.2	3.2
			32						1.7	2	2.9
			40							1.9	2.6
50								2.2			
63											

		E. S800S								
Char:		D								
L.	Icu [kA]	50								
	In [A]	25	32	40	50	63	80	100	125	
S200	K	10	0.5	T	T	T	T	T	T	T
			1	T	T	T	T	T	T	T
			1.6	T	T	T	T	T	T	T
			2	2.3	T	T	T	T	T	T
			3	0.7	1.3	4.4	T	T	T	T
			4	0.7	1	2.2	4.4	T	T	T
			6	0.6	0.8	1.5	2.5	3.6	T	T
			8	0.5	0.7	1.1	1.5	2	4	5.5
			10	0.5	0.7	1.1	1.5	2	4	5.5
			13		0.6	0.9	1.2	1.5	2.6	3.4
			16			0.9	1.2	1.5	2.6	3.4
			20				0.9	1.1	1.8	2.2
			25					1.1	1.8	2.2
			32						1.7	2
			40							1.9
50										
63										

E. = feed side

L. = load side

T = Total selectivity up to breaking capacity of the switch on load side

Selectivity limit values indicated in kA

MCBs technical details

Coordination tables: selectivity

S800S - S200 M @ 230/400 V

		E. S800S									
		B									
L.	Char.	Icu [kA]	50								
			In [A]	25	32	40	50	63	80	100	125
S200M	B	15	6			0.4	0.5	0.7	1	1.5	2.6
			10				0.4	0.6	0.7	1	1.4
			13					0.5	0.7	0.9	1.3
			16						0.7	0.9	1.3
			20							0.9	1.3
			25							0.9	1.3
			32							0.8	1.1
			40							0.8	1.1
			50								1
			63								0.9

		E. S800S									
		B									
L.	Char.	Icu [kA]	50								
			In [A]	25	32	40	50	63	80	100	125
S200M	C	15	0.5	T	T	T	T	T	T	T	T
			1	3.3	T	T	T	T	T	T	T
			1.6	0.6	1.3	T	T	T	T	T	T
			2	0.4	0.7	1.3	T	T	T	T	T
			3		0.4	0.6	0.7	1.1	2.6	8.8	T
			4		0.4	0.6	0.7	1	1.7	3.1	7
			6			0.4	0.5	0.7	1	1.5	2.6
			8				0.4	0.6	0.7	1	1.4
			10				0.4	0.6	0.7	1	1.4
			13					0.5	0.7	0.9	1.3
			16						0.7	0.9	1.3
			20							0.9	1.3
			25							0.9	1.3
			32							0.8	1.1
			40							0.8	1.1
			50								1
			63								0.9

E. = feed side

L. = load side

T = Total selectivity up to breaking capacity of the switch on load side

Selectivity limit values indicated in kA

MCBs technical details

Coordination tables: selectivity

		E. S800S									
		B									
L.	Char.	Icu [kA]	50								
		In [A]	25	32	40	50	63	80	100	125	
S200M	D	15	0.5	T	T	T	T	T	T	T	T
			1	0.8	5	T	T	T	T	T	T
			1.6	0.5	1	2.3	T	T	T	T	T
			2	0.3	0.5	0.7	2.3	T	T	T	T
			3		0.4	0.5	0.7	1.2	2.5	8.6	T
			4		0.4	0.4	0.7	1	1.7	3	7.7
			6				0.6	0.8	1.2	2	3.6
			8					0.7	0.9	1.3	2
			10						0.9	1.3	2
			13							1	1.5
			16								1.5
			20								
			25								
			32								
			40								
50											
63											

		E. S800S									
		B									
L.	Char.	Icu [kA]	50								
		In [A]	25	32	40	50	63	80	100	125	
S200M	K	15	0.5	T	T	T	T	T	T	T	T
			1	0.8	5	T	T	T	T	T	T
			1.6	0.5	1	2.3	T	T	T	T	T
			2	0.3	0.5	0.7	2.3	T	T	T	T
			3		0.4	0.5	0.7	1.2	2.5	8.6	T
			4		0.4	0.4	0.7	1	1.7	3	7.7
			6				0.6	0.8	1.2	2	3.6
			8					0.7	0.9	1.3	2
			10						0.9	1.3	2
			13							1	1.5
			16								1.5
			20								
			25								
			32								
			40								
50											
63											

E. = feed side

L. = load side

T = Total selectivity up to breaking capacity of the switch on load side

Selectivity limit values indicated in kA

MCBs technical details

Coordination tables: selectivity

		E. S800S										
		C										
L.	Char.	Icu [kA]	50									
			In [A]	25	32	40	50	63	80	100	125	
S200M	B	15	6		0.4	0.5	0.7	0.9	1.4	2.4	4.8	
			10		0.3	0.4	0.5	0.7	0.9	1.3	2	
			13		0.3	0.4	0.5	0.7	0.9	1.3	1.9	
			16		0.3	0.4	0.5	0.7	0.9	1.3	1.9	
			20			0.4	0.5	0.7	0.9	1.2	1.8	
			25			0.4	0.5	0.7	0.9	1.2	1.8	
			32				0.5	0.6	0.8	1	1.4	
			40					0.6	0.8	1	1.4	
			50						0.7	0.9	1.3	
		63						0.9	1.2			

		E. S800S										
		C										
L.	Char.	Icu [kA]	50									
			In [A]	25	32	40	50	63	80	100	125	
S200M	C	15	0.5	T	T	T	T	T	T	T	T	T
			1	T	T	T	T	T	T	T	T	T
			1.6	0.6	T	T	T	T	T	T	T	T
			2	0.5	1	T	T	T	T	T	T	T
			3	0.3	0.5	0.7	1.2	2.1	6.4	T	T	
			4	0.3	0.4	0.7	1	1.5	2.6	6.1	T	
			6		0.4	0.5	0.7	0.9	1.4	2.4	4.8	
			8		0.3	0.4	0.5	0.7	0.9	1.3	2	
			10		0.3	0.4	0.5	0.7	0.9	1.3	2	
			13		0.3	0.4	0.5	0.7	0.9	1.3	1.9	
			16		0.3	0.4	0.5	0.7	0.9	1.3	1.9	
			20			0.4	0.5	0.7	0.9	1.2	1.8	
			25			0.4	0.5	0.7	0.9	1.2	1.8	
			32				0.5	0.6	0.8	1	1.4	
			40					0.6	0.8	1	1.4	
50						0.7	0.9	1.3				
		63						0.9	1.2			

E. = feed side

L. = load side

T = Total selectivity up to breaking capacity of the switch on load side

Selectivity limit values indicated in kA

MCBs technical details

Coordination tables: selectivity

		E. S800S									
		C									
L.	Char.	I _{cu} [kA]	50								
		I _n [A]	25	32	40	50	63	80	100	125	
S200M	D	15	0.5	T	T	T	T	T	T	T	T
			1	2.1	T	T	T	T	T	T	T
			1.6	0.8	2.3	T	T	T	T	T	T
			2	0.4	0.7	2.3	T	T	T	T	T
			3	0.3	0.5	0.7	1.2	2.2	6.4	T	T
			4	0.3	0.4	0.7	1	1.4	2.6	6.2	T
			6		0.4	0.6	0.8	1.1	1.8	3.2	6.4
			8			0.5	0.7	0.9	1.2	1.8	2.8
			10				0.7	0.9	1.2	1.8	2.8
			13					0.7	1	1.4	2
			16						1	1.4	2
			20							1	1.4
			25								1.4
			32								

		E. S800S									
		C									
L.	Char.	I _{cu} [kA]	50								
		I _n [A]	25	32	40	50	63	80	100	125	
S200M	K	15	0.5	T	T	T	T	T	T	T	T
			1	2.1	T	T	T	T	T	T	T
			1.6	0.8	2.3	T	T	T	T	T	T
			2	0.4	0.7	2.3	T	T	T	T	T
			3	0.3	0.5	0.7	1.2	2.2	6.4	T	T
			4	0.3	0.4	0.7	1	1.4	2.6	6.2	T
			6		0.4	0.6	0.8	1.1	1.8	3.2	6.4
			8			0.5	0.7	0.9	1.2	1.8	2.8
			10				0.7	0.9	1.2	1.8	2.8
			13					0.7	1	1.4	2
			16						1	1.4	2
			20							1	1.4
			25								1.4
			32								

E. = feed side

L. = load side

T = Total selectivity up to breaking capacity of the switch on load side

Selectivity limit values indicated in kA

MCBs technical details

Coordination tables: selectivity

		E. S800S									
		D									
L.	Char.	Icu [kA]	50								
			In [A]	25	32	40	50	63	80	100	125
S200M	B	15	6	0.5	1	1.2	2	2.8	T	T	T
			10	0.4	0.6	0.8	1.1	1.4	2.8	3.9	7.4
			13	0.4	0.6	0.8	1.1	1.4	2.5	3.3	5.6
			16		0.6	0.8	1.1	1.4	2.5	3.3	5.6
			20			0.8	1.1	1.3	2.3	3	4.7
			25			0.8	1.1	1.3	2.3	3	4.7
			32				0.9	1.1	1.9	2.4	3.7
			40					1.1	1.9	2.4	3.7
			50						1.5	1.9	2.3
			63							1.7	2.3

		E. S800S										
		D										
L.	Char.	Icu [kA]	50									
			In [A]	25	32	40	50	63	80	100	125	
S200M	C	15	0.5	T	T	T	T	T	T	T	T	T
			1	T	T	T	T	T	T	T	T	T
			1.6	T	T	T	T	T	T	T	T	T
			2	T	T	T	T	T	T	T	T	T
			3	0.7	2.2	4.4	T	T	T	T	T	T
			4	0.7	1.3	2.2	4.4	7.7	T	T	T	
			6	0.5	1	1.2	2	2.8	9.9	T	T	
			8	0.4	0.6	0.8	1.1	1.4	2.8	3.9	7.4	
			10	0.4	0.6	0.8	1.1	1.4	2.8	3.9	7.4	
			13	0.4	0.6	0.8	1.1	1.4	2.5	3.3	5.6	
			16		0.6	0.8	1.1	1.4	2.5	3.3	5.6	
			20			0.8	1.1	1.3	2.3	3	4.7	
			25			0.8	1.1	1.3	2.3	3	4.7	
			32				0.9	1.1	1.9	2.4	3.7	
			40					1.1	1.9	2.4	3.7	
			50						1.5	1.9	2.3	
63							1.7	2.3				

E. = feed side

L. = load side

T = Total selectivity up to breaking capacity of the switch on load side

Selectivity limit values indicated in kA

MCBs technical details

Coordination tables: selectivity

		E. S800S									
Char.		D									
L.	Icu [kA]	50									
	In [A]	25	32	40	50	63	80	100	125		
S200M	D	15	0.5	T	T	T	T	T	T	T	T
			1	T	T	T	T	T	T	T	T
			1.6	T	T	T	T	T	T	T	T
			2	2.3	T	T	T	T	T	T	T
			3	0.7	1.3	4.4	T	T	T	T	T
			4	0.7	1	2.2	4.4	7.7	T	T	T
			6	0.6	0.8	1.5	2.5	3.6	T	T	T
			8	0.5	0.7	1.1	1.5	2	4	5.5	T
			10	0.5	0.7	1.1	1.5	2	4	5.5	T
			13		0.6	0.9	1.2	1.5	2.6	3.4	5.2
			16			0.9	1.2	1.5	2.6	3.4	5.2
			20				0.9	1.1	1.8	2.2	3.2
			25					1.1	1.8	2.2	3.2
			32						1.7	2	2.9
			40							1.9	2.6
50								2.2			
63											

		E. S800S								
Char.		D								
L.	Icu [kA]	50								
	In [A]	25	32	40	50	63	80	100	125	
S200M	K	15	0.5	T	T	T	T	T	T	T
			1	T	T	T	T	T	T	T
			1.6	T	T	T	T	T	T	T
			2	2.3	T	T	T	T	T	T
			3	0.7	1.3	4.4	T	T	T	T
			4	0.7	1	2.2	4.4	7.7	T	T
			6	0.6	0.8	1.5	2.5	3.6	T	T
			8	0.5	0.7	1.1	1.5	2	4	5.5
			10	0.5	0.7	1.1	1.5	2	4	5.5
			13		0.6	0.9	1.2	1.5	2.6	3.4
			16			0.9	1.2	1.5	2.6	3.4
			20				0.9	1.1	1.8	2.2
			25					1.1	1.8	2.2
			32						1.7	2
			40							1.9
50										
63										

E. = feed side

L. = load side

T = Total selectivity up to breaking capacity of the switch on load side

Selectivity limit values indicated in kA

MCBs technical details

Coordination tables: selectivity

S800S - S200 P @ 230/400 V

		E. S800S									
		B									
L.	Char.	Icu [kA]	50								
		In [A]	25	32	40	50	63	80	100	125	
S200P	B	25	6		0.4	0.5	0.7	1	1.5	2.6	
			10			0.4	0.6	0.7	1	1.4	
			13				0.5	0.7	0.9	1.3	
			16					0.7	0.9	1.3	
			20						0.9	1.3	
			25						0.9	1.3	
	15	32							0.8	1.1	
		40							0.8	1.1	
		50								1	
		63								0.9	

		E. S800S										
		B										
L.	Char.	Icu [kA]	50									
		In [A]	25	32	40	50	63	80	100	125		
S200P	C	25	0.5	T	T	T	T	T	T	T	T	
			1	3.3	T	T	T	T	T	T	T	
			1.6	0.6	1.3	T	T	T	T	T	T	
			2	0.4	0.7	1.2	T	T	T	T	T	
			3		0.4	0.6	0.7	1.1	2.6	8.8	T	
			4		0.4	0.6	0.7	1	1.7	3.1	7	
			6			0.4	0.5	0.7	1	1.5	2.6	
			8				0.4	0.6	0.7	1	1.4	
			10				0.4	0.6	0.7	1	1.4	
			13					0.5	0.7	0.9	1.3	
			16						0.7	0.9	1.3	
			20							0.9	1.3	
			25							0.9	1.3	
			15	32							0.8	1.1
				40							0.8	1.1
				50								1
63									0.9			

E. = feed side

L. = load side

T = Total selectivity up to breaking capacity of the switch on load side

Selectivity limit values indicated in kA

MCBs technical details

Coordination tables: selectivity

		E. S800S										
Char.		B										
L.		Icu [kA]	50									
			In [A]	25	32	40	50	63	80	100	125	
S200P	K	25	0.2	T	T	T	T	T	T	T	T	T
			0.3	T	T	T	T	T	T	T	T	T
			0.5	T	T	T	T	T	T	T	T	T
			0.75	T	T	T	T	T	T	T	T	T
			1	0.8	5	T	T	T	T	T	T	T
			1.6	0.5	1	2.3	T	T	T	T	T	T
			2	0.3	0.5	0.7	2.1	T	T	T	T	T
			3		0.4	0.5	0.7	1.2	2.5	8.6	T	
			4		0.4	0.4	0.7	1	1.7	3	7.7	
			6				0.6	0.8	1.2	2	3.6	
			8					0.7	0.9	1.3	2	
			10						0.9	1.3	2	
		13							1	1.5		
		16								1.5		
		20										
		25										
		15		32								
				40								
		50										
		63										

		E. S800S										
Char.		C										
L.		Icu [kA]	50									
			In [A]	25	32	40	50	63	80	100	125	
S200P	B	25	6			0.4	0.5	0.7	1	1.5	2.6	
			10				0.4	0.6	0.7	1	1.4	
			13					0.5	0.7	0.9	1.3	
			16						0.7	0.9	1.3	
			20							0.9	1.3	
			25							0.9	1.3	
		15		32						0.8	1.1	
				40						0.8	1.1	
				50							1	
				63							0.9	

E. = feed side

L. = load side

T = Total selectivity up to breaking capacity of the switch on load side

Selectivity limit values indicated in kA

MCBs technical details

Coordination tables: selectivity

		E.		S8005								
Char.		C										
L.		I _{cu} [kA]	50									
			I _n [A]	25	32	40	50	63	80	100	125	
S200P	C	25	0.5	T	T	T	T	T	T	T	T	T
			1	3.3	T	T	T	T	T	T	T	T
			1.6	0.6	1.3	T	T	T	T	T	T	T
			2	0.4	0.7	1.3	T	T	T	T	T	T
			3		0.4	0.6	0.7	1.1	2.6	8.8	T	
			4		0.4	0.6	0.7	1	1.7	3.1	7	
			6			0.4	0.5	0.7	1	1.5	2.6	
			8				0.4	0.6	0.7	1	1.4	
			10				0.4	0.6	0.7	1	1.4	
			13					0.5	0.7	0.9	1.3	
		16						0.7	0.9	1.3		
		20							0.9	1.3		
		25							0.9	1.3		
		32							0.8	1.1		
		40							0.8	1.1		
		50								1		
		63									0.9	

		E.		S8005								
Char.		C										
L.		I _{cu} [kA]	50									
			I _n [A]	25	32	40	50	63	80	100	125	
S200P	K	25	0.2	T	T	T	T	T	T	T	T	T
			0.3	T	T	T	T	T	T	T	T	T
			0.5	T	T	T	T	T	T	T	T	T
			0.75	T	T	T	T	T	T	T	T	T
			1	0.8	5	T	T	T	T	T	T	T
			1.6	0.5	1	2.3	T	T	T	T	T	T
			2	0.3	0.5	0.7	2.3	T	T	T	T	T
			3		0.4	0.5	0.7	1.2	2.5	8.6	T	
			4		0.4	0.4	0.7	1	1.7	3	7.7	
			6				0.6	0.8	1.2	2	3.6	
		8					0.7	0.9	1.3	2		
		10						0.9	1.3	2		
		13							1	1.5		
		16								1.5		
		20										
		25										
		32										
40												
50												
63												

E. = feed side

L. = load side

T = Total selectivity up to breaking capacity of the switch on load side

Selectivity limit values indicated in kA

MCBs technical details

Coordination tables: selectivity

		E. S800S									
		D									
L.	Char.	Icu [kA]	50								
			In [A]	25	32	40	50	63	80	100	125
S200P	B	25	6	0.5	1	1.2	2	2.8	9.9	21.3	T
			10	0.4	0.6	0.8	1.1	1.4	2.8	3.9	7.4
			13	0.4	0.6	0.8	1.1	1.4	2.5	3.3	5.6
			16		0.6	0.8	1.1	1.4	2.5	3.3	5.6
			20			0.8	1.1	1.3	2.3	3	4.7
			25			0.8	1.1	1.3	2.3	3	4.7
	15	32				0.9	1.1	1.9	2.4	3.7	
		40					1.1	1.9	2.4	3.7	
		50						1.5	1.9	2.3	
		63							1.7	2.3	

		E. S800S										
		D										
L.	Char.	Icu [kA]	50									
			In [A]	25	32	40	50	63	80	100	125	
S200P	C	25	0.5	T	T	T	T	T	T	T	T	T
			1	T	T	T	T	T	T	T	T	T
			1.6	T	T	T	T	T	T	T	T	T
			2	T	T	T	T	T	T	T	T	T
			3	0.7	2.2	4.4	T	T	T	T	T	T
			4	0.7	1.3	2.2	4.4	7.7	T	T	T	
			6	0.5	1	1.2	2	2.8	9.9	22	T	
			8	0.4	0.6	0.8	1.1	1.4	2.8	3.9	7.4	
			10	0.4	0.6	0.8	1.1	1.4	2.8	3.9	7.4	
			13	0.4	0.6	0.8	1.1	1.4	2.5	3.3	5.6	
			16		0.6	0.8	1.1	1.4	2.5	3.3	5.6	
			20			0.8	1.1	1.3	2.3	3	4.7	
			25			0.8	1.1	1.3	2.3	3	4.7	
			15	32				0.9	1.1	1.9	2.4	3.7
				40					1.1	1.9	2.4	3.7
				50						1.5	1.9	2.3
				63							1.7	2.3

E. = feed side

L. = load side

T = Total selectivity up to breaking capacity of the switch on load side

Selectivity limit values indicated in kA

MCBs technical details

Coordination tables: selectivity

		E. S800S										
		D										
L.	Char.	Icu [kA]	50									
			In [A]	25	32	40	50	63	80	100	125	
S200P	K	25	0.2	T	T	T	T	T	T	T	T	T
			0.3	T	T	T	T	T	T	T	T	T
			0.5	T	T	T	T	T	T	T	T	T
			0.75	T	T	T	T	T	T	T	T	T
			1	T	T	T	T	T	T	T	T	T
			1.6	T	T	T	T	T	T	T	T	T
			2	2.3	T	T	T	T	T	T	T	T
			3	0.7	1.3	4.4	T	T	T	T	T	T
			4	0.7	1	2.2	4.4	7.7	T	T	T	T
			6	0.6	0.8	1.5	2.5	3.6	12	24.2	T	
		8	0.5	0.7	1.1	1.5	2	4	5.5	9.9		
		10	0.5	0.7	1.1	1.5	2	4	5.5	9.9		
		13		0.6	0.9	1.2	1.5	2.6	3.4	5.2		
		16			0.9	1.2	1.5	2.6	3.4	5.2		
		20				0.9	1.1	1.8	2.2	3.2		
		25						1.8	2.2	3.2		
		32							1.7	2	2.9	
		40								1.9	2.6	
		50									2.2	
		63										

E. = feed side

L. = load side

T = Total selectivity up to breaking capacity of the switch on load side

Selectivity limit values indicated in kA

MCBs technical details

Coordination tables: selectivity

S800S – S400E/S450E @230/400V

Load s.	Char.	Supply s.		S800S									
		Icu [kA]	In [A]	B									
				50	25	32	40	50	63	80	100	125	
S400E S450E FS401E FS451E FS403E FS453E	B, C	Icn [kA] 6	6				0.4	0.5	0.6	0.9	1.4	2.4	
			10					0.4	0.5	0.7	0.9	1.3	
			13						0.5	0.7	0.9	1.2	
			16							0.7	0.9	1.2	
			20								0.9	1.2	
			25								0.9	1.2	
			32									0.7	1
			40									0.7	1
			50										0.9
			63										

Load s.	Char.	Supply s.		S800S								
		Icu [kA]	In [A]	C								
				50	25	32	40	50	63	80	100	125
S400E S450E FS401E FS451E FS403E FS453E	B, C	Icn [kA] 6	6			0.4	0.5	0.6	0.9	1.3	2.2	4.4
			10			0.3	0.4	0.5	0.6	0.8	1.2	1.8
			13			0.3	0.4	0.5	0.6	0.8	1.2	1.7
			16			0.3	0.4	0.5	0.6	0.8	1.2	1.7
			20				0.4	0.5	0.6	0.8	1.1	1.6
			25				0.4	0.5	0.6	0.8	1.1	1.6
			32					0.4	0.5	0.7	0.9	1.3
			40						0.5	0.7	0.9	1.3
			50							0.7	0.9	1.2
			63								0.8	1.1

Load s.	Char.	Supply s.		S800S								
		Icu [kA]	In [A]	D, K								
				50	25	32	40	50	63	80	100	125
S400E S450E FS401E FS451E FS403E FS453E	B, C	Icn [kA] 6	6	0.5	0.9	1.1	1.8	2.5	T	T	T	T
			10	0.4	0.5	0.8	1	1.3	2.5	3.5	T	T
			13	0.4	0.5	0.8	1	1.3	2.3	3	5.1	5.1
			16		0.5	0.8	1	1.3	2.3	3	5.1	5.1
			20			0.7	1	1.2	2.1	2.7	4.3	4.3
			25			0.7	1	1.2	2.1	2.7	4.3	4.3
			32				0.9	1	1.7	2.2	3.4	3.4
			40					1	1.7	2.2	3.4	3.4
			50						1.4	1.7	2.1	2.1
			63							1.6	2.1	2.1

MCBs technical details

Coordination tables: selectivity

S800S – S400M @230/400V

Load s.	Char.	Supply s.		S800S								
		Icu [kA]	C									
			In [A]	25	32	40	50	63	80	100	125	
S400M S450M FS401M FS451M FS403M FS453M	B	Icn [kA] 10	6		0.4	0.5	0.6	0.9	1.3	2.2	4.4	
			10		0.3	0.4	0.5	0.6	0.8	1.2	1.8	
			13		0.3	0.4	0.5	0.6	0.8	1.2	1.7	
			16		0.3	0.4	0.5	0.6	0.8	1.2	1.7	
			20			0.4	0.5	0.6	0.8	1.1	1.6	
			25			0.4	0.5	0.6	0.8	1.1	1.6	
			32				0.4	0.5	0.6	0.8	1.1	1.6
			40					0.4	0.5	0.7	0.9	1.3
			50						0.5	0.7	0.9	1.3
			63							0.7	0.9	1.2
									0.9	1.1		

Load s.	Char.	Supply s.		S800S									
		Icu [kA]	C										
			In [A]	25	32	40	50	63	80	100	125		
S400M S450M FS401M FS451M FS403M FS453M	C	50	0.5	T	T	T	T	T	T	T	T	T	
			1	T	T	T	T	T	T	T	T	T	
			1.6	1	T	T	T	T	T	T	T	T	
			2	0	0.9	T	T	T	T	T	T	T	
		25	3	0	0.4	0.7	1.1	1.9	5.8	T	T		
			4	0	0.4	0.6	0.9	1.3	2.4	5.5	T		
			6		0.4	0.5	0.6	0.9	1.3	2.2	4.4		
			8		0.3	0.4	0.5	0.6	0.8	1.2	1.8		
			10		0.3	0.4	0.5	0.6	0.8	1.2	1.8		
			13		0.3	0.4	0.5	0.6	0.8	1.2	1.7		
			16		0.3	0.4	0.5	0.6	0.8	1.2	1.7		
			20			0.4	0.5	0.6	0.8	1.1	1.6		
			15	25			0.4	0.5	0.6	0.8	1.1	1.6	
				32				0.4	0.5	0.6	0.8	1.1	1.6
				40					0.4	0.5	0.7	0.9	1.3
				50						0.5	0.7	0.9	1.3
										0.7	0.9	1.2	
											0.8	1.1	

MCBs technical details

Coordination tables: selectivity

S800S – S400M @230/400V

Load s.	Char.	Supply s.		S800S							
		Icu [kA]	In [A]	D, K							
				50	25	32	40	50	63	80	100
S400M S450M FS401M FS451M FS403M FS453M	B	Icn [kA] 10	6	0.5	0.9	1.1	1.8	2.5	9	T	T
			10	0.4	0.5	0.8	1	1.3	2.5	3.5	6.7
			13	0.4	0.5	0.8	1	1.3	2.3	3	5.5
			16		0.5	0.8	1	1.3	2.3	3	5.1
			20			0.7	1	1.2	2.1	2.7	4.3
			25			0.7	1	1.2	2.1	2.7	4.3
			32				0.9	1	1.7	2.2	3.4
			40					1	1.7	2.2	3.4
			50						1.4	1.7	2.1
			63								1.6

Load s.	Char.	Supply s.		S800S								
		Icu [kA]	In [A]	D, K								
				50	25	32	40	50	63	80	100	125
S400M S450M FS401M FS451M FS403M FS453M	C	50	0.5	T	T	T	T	T	T	T	T	T
			1	T	T	T	T	T	T	T	T	T
			1.6	T	T	T	T	T	T	T	T	T
			2	T	T	T	T	T	T	T	T	T
			3	0.7	2	4	T	T	T	T	T	T
		25	4	0.6	1.2	2	4	7	T	T	T	T
			6	0.5	0.9	1.1	1.8	2.5	9	T	T	
			8	0.4	0.5	0.8	1	1.3	2.5	3.5	6.7	
			10	0.4	0.5	0.8	1	1.3	2.5	3.5	6.7	
			13	0.4	0.5	0.8	1	1.3	2.3	3	2.1	
			16		0.5	0.8	1	1.3	2.3	3	5.1	
			20			0.7	1	1.2	2.1	2.7	4.3	
			15	25			0.7	1	1.2	2.1	2.7	4.3
				32				0.9	1	1.7	2.2	3.4
				40					1	1.7	2.2	3.4
		50							1.4	1.7	2.1	
		63									1.6	2.1

MCBs technical details

Coordination tables: selectivity

S800N - S200 @ 230/400 V

		E.		S800N							
		Char.		B							
L.		Icu [kA]	36								
			In [A]	25	32	40	50	63	80	100	125
S200	B	10	6			0.4	0.5	0.7	1	1.5	2.6
			10				0.4	0.6	0.7	1	1.4
			13					0.5	0.7	0.9	1.3
			16						0.7	0.9	1.3
			20							0.9	1.3
			25							0.9	1.3
			32							0.8	1.1
			40							0.8	1.1
			50								1
			63								

		E.		S800N								
		Char.		B								
L.		Icu [kA]	36									
			In [A]	25	32	40	50	63	80	100	125	
S200	C	10	0.5	T	T	T	T	T	T	T	T	T
			1	3.3	T	T	T	T	T	T	T	T
			1.6	0.6	1.3	T	T	T	T	T	T	T
			2	0.4	0.7	1.2	T	T	T	T	T	T
			3		0.4	0.6	0.7	1.1	2.6	T	T	
			4		0.4	0.6	0.7	1	1.7	3.1	T	
			6			0.4	0.5	0.7	1	1.5	2.6	
			8				0.4	0.6	0.7	1	1.4	
			10				0.4	0.6	0.7	1	1.4	
			13					0.5	0.7	0.9	1.3	
			16						0.7	0.9	1.3	
			20							0.9	1.3	
			25							0.9	1.3	
			32							0.8	1.1	
			40							0.8	1.1	
			50								1	
63									0.9			

E. = feed side

L. = load side

T = Total selectivity up to breaking capacity of the switch on load side

Selectivity limit values indicated in kA

MCBs technical details

Coordination tables: selectivity

		E. S800N										
		B										
L.	Char.	Icu [kA]	36									
			In [A]	25	32	40	50	63	80	100	125	
S200	D	10	0.5	T	T	T	T	T	T	T	T	T
			1	0.8	5	T	T	T	T	T	T	T
			1.6	0.5	1	2.3	T	T	T	T	T	T
			2	0.3	0.5	0.7	2.3	T	T	T	T	T
			3		0.4	0.5	0.7	1.2	2.5	T	T	T
			4		0.4	0.4	0.7	1	1.7	3	T	T
			6				0.6	0.8	1.2	2	3.6	
			8					0.7	0.9	1.3	2	
			10						0.9	1.3	2	
			13							1	1.5	
			16									1.5
			20									
			25									
			32									
			40									
50												
63												

		E. S800N										
		B										
L.	Char.	Icu [kA]	36									
			In [A]	25	32	40	50	63	80	100	125	
S200	K	10	0.5	T	T	T	T	T	T	T	T	T
			1	0.8	5	T	T	T	T	T	T	T
			1.6	0.5	1	2.3	T	T	T	T	T	T
			2	0.3	0.5	0.7	2.3	T	T	T	T	T
			3		0.4	0.5	0.7	1.2	2.5	T	T	T
			4		0.4	0.4	0.7	1	1.7	3	T	T
			6				0.6	0.8	1.2	2	3.6	
			8					0.7	0.9	1.3	2	
			10						0.9	1.3	2	
			13							1	1.5	
			16									1.5
			20									
			25									
			32									
			40									
50												
63												

E. = feed side

L. = load side

T = Total selectivity up to breaking capacity of the switch on load side

Selectivity limit values indicated in kA

MCBs technical details

Coordination tables: selectivity

		E.	S800N								
		Char.	C								
L.		Icu [kA]	36								
			In [A]	25	32	40	50	63	80	100	125
S200	B	10	6		0.4	0.5	0.7	0.9	1.4	2.4	4.8
			10		0.3	0.4	0.5	0.7	0.9	1.3	2
			13		0.3	0.4	0.5	0.7	0.9	1.3	1.9
			16		0.3	0.4	0.5	0.7	0.9	1.3	1.9
			20			0.4	0.5	0.7	0.9	1.2	1.8
			25			0.4	0.5	0.7	0.9	1.2	1.8
			32				0.5	0.6	0.8	1	1.4
			40					0.6	0.8	1	1.4
			50						0.7	0.9	1.3
			63							0.9	1.2

		E.	S800N									
		Char.	C									
L.		Icu [kA]	36									
			In [A]	25	32	40	50	63	80	100	125	
S200	C	10	0.5	T	T	T	T	T	T	T	T	T
			1	T	T	T	T	T	T	T	T	T
			1.6	0.6	T	T	T	T	T	T	T	T
			2	0.5	1	T	T	T	T	T	T	T
			3	0.3	0.5	0.7	1.2	2.1	T	T	T	
			4	0.3	0.4	0.7	1	1.5	2.6	T	T	
			6		0.4	0.5	0.7	0.9	1.4	2.4	4.8	
			8		0.3	0.4	0.5	0.7	0.9	1.3	2	
			10		0.3	0.4	0.5	0.7	0.9	1.3	2	
			13		0.3	0.4	0.5	0.7	0.9	1.3	1.9	
			16		0.3	0.4	0.5	0.7	0.9	1.3	1.9	
			20			0.4	0.5	0.7	0.9	1.2	1.8	
			25			0.4	0.5	0.7	0.9	1.2	1.8	
			32				0.5	0.6	0.8	1	1.4	
			40					0.6	0.8	1	1.4	
			50						0.7	0.9	1.3	
63							0.9	1.2				

E. = feed side

L. = load side

T = Total selectivity up to breaking capacity of the switch on load side

Selectivity limit values indicated in kA

MCBs technical details

Coordination tables: selectivity

		E.		S800N								
		Char.		C								
L.		Icu [kA]	36									
			In [A]	25	32	40	50	63	80	100	125	
S200	D	10	0.5	T	T	T	T	T	T	T	T	T
			1	2.1	T	T	T	T	T	T	T	T
			1.6	0.8	2.3	T	T	T	T	T	T	T
			2	0.4	0.7	2.3	T	T	T	T	T	T
			3	0.3	0.5	0.7	1.2	2.2	T	T	T	T
			4	0.3	0.4	0.7	1	1.4	2.6	T	T	T
			6		0.4	0.6	0.8	1.1	1.8	3.2	T	T
			8			0.5	0.7	0.9	1.2	1.8	2.8	T
			10				0.7	0.9	1.2	1.8	2.8	T
			13					0.7	1	1.4	2	T
			16						1	1.4	2	T
			20							1	1.4	T
			25								1.4	T
			32									T
			40									T
50									T			
63									T			

		E.		S800N								
		Char.		C								
L.		Icu [kA]	36									
			In [A]	25	32	40	50	63	80	100	125	
S200	K	10	0.5	T	T	T	T	T	T	T	T	T
			1	2.1	T	T	T	T	T	T	T	T
			1.6	0.8	2.3	T	T	T	T	T	T	T
			2	0.4	0.7	2.3	T	T	T	T	T	T
			3	0.3	0.5	0.7	1.2	2.2	T	T	T	T
			4	0.3	0.4	0.7	1	1.4	2.6	T	T	T
			6		0.4	0.6	0.8	1.1	1.8	3.2	T	T
			8			0.5	0.7	0.9	1.2	1.8	2.8	T
			10				0.7	0.9	1.2	1.8	2.8	T
			13					0.7	1	1.4	2	T
			16						1	1.4	2	T
			20							1	1.4	T
			25								1.4	T
			32									T
			40									T
50									T			
63									T			

E. = feed side

L. = load side

T = Total selectivity up to breaking capacity of the switch on load side

Selectivity limit values indicated in kA

MCBs technical details

Coordination tables: selectivity

		E.		S800N								
L.		Char.		D								
		Icu [kA]		36								
		In [A]		25	32	40	50	63	80	100	125	
S200	B	10	6	0.5	1	1.2	2	2.8	T	T	T	
			10	0.4	0.6	0.8	1.1	1.4	2.8	3.9	T	
			13	0.4	0.6	0.8	1.1	1.4	2.5	3.3	5.6	
			16		0.6	0.8	1.1	1.4	2.5	3.3	5.6	
			20			0.8	1.1	1.3	2.3	3	4.7	
			25			0.8	1.1	1.3	2.3	3	4.7	
			32				0.9	1.1	1.9	2.4	3.7	
			40					1.1	1.9	2.4	3.7	
			50						1.5	1.9	2.3	
			63							1.7	2.3	

		E.		S800N								
L.		Char.		D								
		Icu [kA]		36								
		In [A]		25	32	40	50	63	80	100	125	
S200	C	10	0.5	T	T	T	T	T	T	T	T	
			1	T	T	T	T	T	T	T	T	
			1.6	T	T	T	T	T	T	T	T	
			2	T	T	T	T	T	T	T	T	
			3	0.7	2.2	4.4	T	T	T	T	T	
			4	0.7	1.3	2.2	4.4	T	T	T	T	
			6	0.5	1	1.2	2	2.8	T	T	T	
			8	0.4	0.6	0.8	1.1	1.4	2.8	3.9	T	
			10	0.4	0.6	0.8	1.1	1.4	2.8	3.9	T	
			13	0.4	0.6	0.8	1.1	1.4	2.5	3.3	5.6	
			16		0.6	0.8	1.1	1.4	2.5	3.3	5.6	
			20			0.8	1.1	1.3	2.3	3	4.7	
			25			0.8	1.1	1.3	2.3	3	4.7	
			32				0.9	1.1	1.9	2.4	3.7	
			40					1.1	1.9	2.4	3.7	
			50						1.5	1.9	2.3	
63							1.7	2.3				

E. = feed side

L. = load side

T = Total selectivity up to breaking capacity of the switch on load side

Selectivity limit values indicated in kA

MCBs technical details

Coordination tables: selectivity

		E. S800N										
Char.		D										
L.	Icu [kA]	36										
		In [A]	25	32	40	50	63	80	100	125		
S200	D	10	0.5	T	T	T	T	T	T	T	T	T
			1	T	T	T	T	T	T	T	T	T
			1.6	T	T	T	T	T	T	T	T	T
			2	2.3	T	T	T	T	T	T	T	T
			3	0.7	1.3	4.4	T	T	T	T	T	T
			4	0.7	1	2.2	4.4	T	T	T	T	T
			6	0.6	0.8	1.5	2.5	3.6	T	T	T	T
			8	0.5	0.7	1.1	1.5	2	4	5.5	T	T
			10	0.5	0.7	1.1	1.5	2	4	5.5	T	T
			13		0.6	0.9	1.2	1.5	2.6	3.4	5.2	T
			16			0.9	1.2	1.5	2.6	3.4	5.2	T
			20				0.9	1.1	1.8	2.2	3.2	T
			25					1.1	1.8	2.2	3.2	T
			32						1.7	2	2.9	T
			40							1.9	2.6	T
			50								2.2	T
63									T			

		E. S800N										
Char.		D										
L.	Icu [kA]	36										
		In [A]	25	32	40	50	63	80	100	125		
S200	K	10	0.5	T	T	T	T	T	T	T	T	T
			1	T	T	T	T	T	T	T	T	T
			1.6	T	T	T	T	T	T	T	T	T
			2	2.3	T	T	T	T	T	T	T	T
			3	0.7	1.3	4.4	T	T	T	T	T	T
			4	0.7	1	2.2	4.4	T	T	T	T	T
			6	0.6	0.8	1.5	2.5	3.6	T	T	T	T
			8	0.5	0.7	1.1	1.5	2	4	5.5	T	T
			10	0.5	0.7	1.1	1.5	2	4	5.5	T	T
			13		0.6	0.9	1.2	1.5	2.6	3.4	5.2	T
			16			0.9	1.2	1.5	2.6	3.4	5.2	T
			20				0.9	1.1	1.8	2.2	3.2	T
			25					1.1	1.8	2.2	3.2	T
			32						1.7	2	2.9	T
			40							1.9	2.6	T
			50								2.2	T
63									T			

E. = feed side

L. = load side

T = Total selectivity up to breaking capacity of the switch on load side

Selectivity limit values indicated in kA

MCBs technical details

Coordination tables: selectivity

S800N - S200M @ 230/400 V

		E.		S800N							
		Char.		B							
L.		Icu [kA]	36								
			In [A]	25	32	40	50	63	80	100	125
S200M	B	15	6			0.4	0.5	0.7	1	1.5	2.6
			10				0.4	0.6	0.7	1	1.4
			13					0.5	0.7	0.9	1.3
			16						0.7	0.9	1.3
			20							0.9	1.3
			25							0.9	1.3
			32							0.8	1.1
			40							0.8	1.1
			50								1
		63								0.9	

		E.		S800N								
		Char.		B								
L.		Icu [kA]	36									
			In [A]	25	32	40	50	63	80	100	125	
S200M	C	15	0.5	T	T	T	T	T	T	T	T	T
			1	3.3	T	T	T	T	T	T	T	T
			1.6	0.6	1.3	T	T	T	T	T	T	T
			2	0.4	0.7	1.3	T	T	T	T	T	T
			3		0.4	0.6	0.7	1.1	2.6	8.8	T	
			4		0.4	0.6	0.7	1	1.7	3.1	7	
			6			0.4	0.5	0.7	1	1.5	2.6	
			8				0.4	0.6	0.7	1	1.4	
			10					0.4	0.6	0.7	1	1.4
			13						0.5	0.7	0.9	1.3
			16							0.7	0.9	1.3
			20								0.9	1.3
			25								0.9	1.3
			32								0.8	1.1
			40								0.8	1.1
					50							
		63								0.9		

E. = feed side

L. = load side

T = Total selectivity up to breaking capacity of the switch on load side

Selectivity limit values indicated in kA

MCBs technical details

Coordination tables: selectivity

		E.		S800N							
L.		Char.		B							
		Icu [kA]		36							
		In [A]		25	32	40	50	63	80	100	125
S200M	D	15	0.5	T	T	T	T	T	T	T	T
			1	0.8	5	T	T	T	T	T	T
			1.6	0.5	1	2.3	T	T	T	T	T
			2	0.3	0.5	0.7	2.3	T	T	T	T
			3		0.4	0.5	0.7	1.2	2.5	8.6	T
			4		0.4	0.4	0.7	1	1.7	3	7.7
			6				0.6	0.8	1.2	2	3.6
			8					0.7	0.9	1.3	2
			10						0.9	1.3	2
			13							1	1.5
			16								1.5
			20								
			25								
			32								
			40								
50											
63											

		E.		S800N							
L.		Char.		B							
		Icu [kA]		36							
		In [A]		25	32	40	50	63	80	100	125
S200M	K	15	0.5	T	T	T	T	T	T	T	T
			1	0.8	5	T	T	T	T	T	T
			1.6	0.5	1	2.3	T	T	T	T	T
			2	0.3	0.5	0.7	2.3	T	T	T	T
			3		0.4	0.5	0.7	1.2	2.5	8.6	T
			4		0.4	0.4	0.7	1	1.7	3	7.7
			6				0.6	0.8	1.2	2	3.6
			8					0.7	0.9	1.3	2
			10						0.9	1.3	2
			13							1	1.5
			16								1.5
			20								
			25								
			32								
			40								
50											
63											

E. = feed side

L. = load side

T = Total selectivity up to breaking capacity of the switch on load side

Selectivity limit values indicated in kA

MCBs technical details

Coordination tables: selectivity

		E. S800N									
		C									
L.	Char.	Icu [kA]	36								
			In [A]	25	32	40	50	63	80	100	125
S200M	B	15	6		0.4	0.5	0.7	0.9	1.4	2.4	4.8
			10		0.3	0.4	0.5	0.7	0.9	1.3	2
			13		0.3	0.4	0.5	0.7	0.9	1.3	1.9
			16		0.3	0.4	0.5	0.7	0.9	1.3	1.9
			20			0.4	0.5	0.7	0.9	1.2	1.8
			25			0.4	0.5	0.7	0.9	1.2	1.8
			32				0.5	0.6	0.8	1	1.4
			40					0.6	0.8	1	1.4
			50						0.7	0.9	1.3
			63							0.9	1.2

		E. S800N										
		C										
L.	Char.	Icu [kA]	36									
			In [A]	25	32	40	50	63	80	100	125	
S200M	C	15	0.5	T	T	T	T	T	T	T	T	T
			1	T	T	T	T	T	T	T	T	T
			1.6	0.6	T	T	T	T	T	T	T	T
			2	0.5	1	T	T	T	T	T	T	T
			3	0.3	0.5	0.7	1.2	2.1	6.4	T	T	
			4	0.3	0.4	0.7	1	1.5	2.6	6.1	T	
			6		0.4	0.5	0.7	0.9	1.4	2.4	4.8	
			8		0.3	0.4	0.5	0.7	0.9	1.3	2	
			10		0.3	0.4	0.5	0.7	0.9	1.3	2	
			13		0.3	0.4	0.5	0.7	0.9	1.3	1.9	
			16		0.3	0.4	0.5	0.7	0.9	1.3	1.9	
			20			0.4	0.5	0.7	0.9	1.2	1.8	
			25			0.4	0.5	0.7	0.9	1.2	1.8	
			32				0.5	0.6	0.8	1	1.4	
			40					0.6	0.8	1	1.4	
			50						0.7	0.9	1.3	
63							0.9	1.2				

E. = feed side

L. = load side

T = Total selectivity up to breaking capacity of the switch on load side

Selectivity limit values indicated in kA

MCBs technical details

Coordination tables: selectivity

		E.		S800N								
		Char.		C								
L.		Icu [kA]	36									
			In [A]	25	32	40	50	63	80	100	125	
S200M	D	15	0.5	T	T	T	T	T	T	T	T	T
			1	2.1	T	T	T	T	T	T	T	T
			1.6	0.8	2.3	T	T	T	T	T	T	T
			2	0.4	0.7	2.3	T	T	T	T	T	T
			3	0.3	0.5	0.7	1.2	2.2	6.4	T	T	
			4	0.3	0.4	0.7	1	1.4	2.6	6.2	T	
			6		0.4	0.6	0.8	1.1	1.8	3.2	6.4	
			8			0.5	0.7	0.9	1.2	1.8	2.8	
			10				0.7	0.9	1.2	1.8	2.8	
			13					0.7	1	1.4	2	
			16						1	1.4	2	
			20							1	1.4	
			25								1.4	
			32									1.4
			40									
50												
63												

		E.		S800N								
		Char.		C								
L.		Icu [kA]	36									
			In [A]	25	32	40	50	63	80	100	125	
S200M	K	15	0.5	T	T	T	T	T	T	T	T	T
			1	2.1	T	T	T	T	T	T	T	T
			1.6	0.8	2.3	T	T	T	T	T	T	T
			2	0.4	0.7	2.3	T	T	T	T	T	T
			3	0.3	0.5	0.7	1.2	2.2	6.4	T	T	
			4	0.3	0.4	0.7	1	1.4	2.6	6.2	T	
			6		0.4	0.6	0.8	1.1	1.8	3.2	6.4	
			8			0.5	0.7	0.9	1.2	1.8	2.8	
			10				0.7	0.9	1.2	1.8	2.8	
			13					0.7	1	1.4	2	
			16						1	1.4	2	
			20							1	1.4	
			25								1.4	
			32									1.4
			40									
50												
63												

E. = feed side

L. = load side

T = Total selectivity up to breaking capacity of the switch on load side

Selectivity limit values indicated in kA

MCBs technical details

Coordination tables: selectivity

		E.	S800N								
Char.		D									
L.	Icu [kA]	36									
		In [A]	25	32	40	50	63	80	100	125	
S200M	B	15	6	0.5	1	1.2	2	2.8	T	T	T
			10	0.4	0.6	0.8	1.1	1.4	2.8	3.9	7.4
			13	0.4	0.6	0.8	1.1	1.4	2.5	3.3	5.6
			16		0.6	0.8	1.1	1.4	2.5	3.3	5.6
			20			0.8	1.1	1.3	2.3	3	4.7
			25			0.8	1.1	1.3	2.3	3	4.7
			32				0.9	1.1	1.9	2.4	3.7
			40					1.1	1.9	2.4	3.7
			50						1.5	1.9	2.3
			63							1.7	2.3

		E.	S800N									
Char.		D										
L.	Icu [kA]	36										
		In [A]	25	32	40	50	63	80	100	125		
S200M	C	15	0.5	T	T	T	T	T	T	T	T	T
			1	T	T	T	T	T	T	T	T	T
			1.6	T	T	T	T	T	T	T	T	T
			2	T	T	T	T	T	T	T	T	T
			3	0.7	2.2	4.4	T	T	T	T	T	T
			4	0.7	1.3	2.2	4.4	7.7	T	T	T	
			6	0.5	1	1.2	2	2.8	T	T	T	
			8	0.4	0.6	0.8	1.1	1.4	2.8	3.9	7.4	
			10	0.4	0.6	0.8	1.1	1.4	2.8	3.9	7.4	
			13	0.4	0.6	0.8	1.1	1.4	2.5	3.3	5.6	
			16		0.6	0.8	1.1	1.4	2.5	3.3	5.6	
			20			0.8	1.1	1.3	2.3	3	4.7	
			25			0.8	1.1	1.3	2.3	3	4.7	
			32				0.9	1.1	1.9	2.4	3.7	
			40					1.1	1.9	2.4	3.7	
			50						1.5	1.9	2.3	
63							1.7	2.3				

E. = feed side

L. = load side

T = Total selectivity up to breaking capacity of the switch on load side

Selectivity limit values indicated in kA

MCBs technical details

Coordination tables: selectivity

		E. S800N										
		D										
L.	Char.	Icu [kA]	36									
			In [A]	25	32	40	50	63	80	100	125	
S200M	D	15	0.5	T	T	T	T	T	T	T	T	T
			1	T	T	T	T	T	T	T	T	T
			1.6	T	T	T	T	T	T	T	T	T
			2	2.3	T	T	T	T	T	T	T	T
			3	0.7	1.3	4.4	T	T	T	T	T	T
			4	0.7	1	2.2	4.4	7.7	T	T	T	T
			6	0.6	0.8	1.5	2.5	3.6	T	T	T	T
			8	0.5	0.7	1.1	1.5	2	4	5.5	T	T
			10	0.5	0.7	1.1	1.5	2	4	5.5	T	T
			13		0.6	0.9	1.2	1.5	2.6	3.4	5.2	5.2
			16			0.9	1.2	1.5	2.6	3.4	5.2	5.2
			20				0.9	1.1	1.8	2.2	3.2	3.2
			25					1.1	1.8	2.2	3.2	3.2
			32						1.7	2	2.9	2.9
			40							1.9	2.6	2.6
50								2.2	2.2			
63												

		E. S800N										
		D										
L.	Char.	Icu [kA]	36									
			In [A]	25	32	40	50	63	80	100	125	
S200M	K	15	0.5	T	T	T	T	T	T	T	T	T
			1	T	T	T	T	T	T	T	T	T
			1.6	T	T	T	T	T	T	T	T	T
			2	2.3	T	T	T	T	T	T	T	T
			3	0.7	1.3	4.4	T	T	T	T	T	T
			4	0.7	1	2.2	4.4	7.7	T	T	T	T
			6	0.6	0.8	1.5	2.5	3.6	T	T	T	T
			8	0.5	0.7	1.1	1.5	2	4	5.5	T	T
			10	0.5	0.7	1.1	1.5	2	4	5.5	T	T
			13		0.6	0.9	1.2	1.5	2.6	3.4	5.2	5.2
			16			0.9	1.2	1.5	2.6	3.4	5.2	5.2
			20				0.9	1.1	1.8	2.2	3.2	3.2
			25					1.1	1.8	2.2	3.2	3.2
			32						1.7	2	2.9	2.9
			40							1.9	2.6	2.6
50								2.2	2.2			
63												

E. = feed side

L. = load side

T = Total selectivity up to breaking capacity of the switch on load side

Selectivity limit values indicated in kA

MCBs technical details

Coordination tables: selectivity

S800N - S200P @ 230/400 V

		E. S800N									
Char.		B									
L.	Icu [kA]	36									
		In [A]	25	32	40	50	63	80	100	125	
S200P C	25	0.5	T	T	T	T	T	T	T	T	T
		1	3.3	T	T	T	T	T	T	T	T
		1.6	0.6	1.3	T	T	T	T	T	T	T
		2	0.4	0.7	1.3	T	T	T	T	T	T
		3		0.4	0.6	0.7	1.1	2.6	8.8	T	
		4		0.4	0.6	0.7	1	1.7	3.1	7	
		6			0.4	0.5	0.7	1	1.5	2.6	
		8				0.4	0.6	0.7	1	1.4	
		10				0.4	0.6	0.7	1	1.4	
		13					0.5	0.7	0.9	1.3	
	16						0.7	0.9	1.3		
	20							0.9	1.3		
	25							0.9	1.3		
	15	32							0.8	1.1	
	40								0.8	1.1	
	50									1	
	63									0.9	

E. = feed side

L. = load side

T = Total selectivity up to breaking capacity of the switch on load side

Selectivity limit values indicated in kA

MCBs technical details

Coordination tables: selectivity

		E.	S800N								
Char.		B									
L.	Icu [kA]	36									
		In [A]	25	32	40	50	63	80	100	125	
S200P K	25	0.2	T	T	T	T	T	T	T	T	T
		0.3	T	T	T	T	T	T	T	T	T
		0.5	T	T	T	T	T	T	T	T	T
		0.75	T	T	T	T	T	T	T	T	T
		1	0.8	5	T	T	T	T	T	T	T
		1.6	0.5	1	2.3	T	T	T	T	T	T
		2	0.3	0.5	0.7	2.1	T	T	T	T	T
		3		0.4	0.5	0.7	1.2	2.5	8.6	T	
		4		0.4	0.4	0.7	1	1.7	3	7.7	
		6				0.6	0.8	1.2	2	3.6	
		8					0.7	0.9	1.3	2	
		10						0.9	1.3	2	
		13							1	1.5	
		16								1.5	
		20									
		25									
		15	32								
40											
50											
63											

		E.	S800N								
Char.		C									
L.	Icu [kA]	36									
		In [A]	25	32	40	50	63	80	100	125	
S200P B	25	6			0.4	0.5	0.7	1	1.5	2.6	
		10				0.4	0.6	0.7	1	1.4	
		13					0.5	0.7	0.9	1.3	
		16						0.7	0.9	1.3	
		20							0.9	1.3	
	25							0.9	1.3		
	15	32							0.8	1.1	
		40							0.8	1.1	
		50								1	
		63								0.9	

E. = feed side

L. = load side

T = Total selectivity up to breaking capacity of the switch on load side

Selectivity limit values indicated in kA

MCBs technical details

Coordination tables: selectivity

		E.		S800N								
L.		Char.		C								
		Icu [kA]	36									
			In [A]	25	32	40	50	63	80	100	125	
S200P	C	25	0.5	T	T	T	T	T	T	T	T	T
			1	3.3	T	T	T	T	T	T	T	T
			1.6	0.6	1.3	T	T	T	T	T	T	T
			2	0.4	0.7	1.3	T	T	T	T	T	T
			3		0.4	0.6	0.7	1.1	2.6	8.8	T	
			4		0.4	0.6	0.7	1	1.7	3.1	7	
			6			0.4	0.5	0.7	1	1.5	2.6	
			8				0.4	0.6	0.7	1	1.4	
			10				0.4	0.6	0.7	1	1.4	
			13					0.5	0.7	0.9	1.3	
		16						0.7	0.9	1.3		
		20							0.9	1.3		
		25							0.9	1.3		
		32							0.8	1.1		
		40							0.8	1.1		
		50								1		
		63									0.9	

		E.		S800N								
L.		Char.		C								
		Icu [kA]	36									
			In [A]	25	32	40	50	63	80	100	125	
S200P	K	25	0.2	T	T	T	T	T	T	T	T	T
			0.3	T	T	T	T	T	T	T	T	T
			0.5	T	T	T	T	T	T	T	T	T
			0.75	T	T	T	T	T	T	T	T	T
			1	0.8	5	T	T	T	T	T	T	T
			1.6	0.5	1	2.3	T	T	T	T	T	T
			2	0.3	0.5	0.7	2.3	T	T	T	T	T
			3		0.4	0.5	0.7	1.2	2.5	8.6	T	
			4		0.4	0.4	0.7	1	1.7	3	7.7	
			6				0.6	0.8	1.2	2	3.6	
		8					0.7	0.9	1.3	2		
		10						0.9	1.3	2		
		13							1	1.5		
		16								1.5		
		20										
		25										
		32										
40												
50												
63												

E. = feed side

L. = load side

T = Total selectivity up to breaking capacity of the switch on load side

Selectivity limit values indicated in kA

MCBs technical details

Coordination tables: selectivity

		E. S800N									
L.	Char.	Icu [kA]	D								
			36								
			In [A]	25	32	40	50	63	80	100	125
S200P	B	25	6	0.5	1	1.2	2	2.8	9.9	21.3	T
			10	0.4	0.6	0.8	1.1	1.4	2.8	3.9	7.4
			13	0.4	0.6	0.8	1.1	1.4	2.5	3.3	5.6
			16		0.6	0.8	1.1	1.4	2.5	3.3	5.6
			20			0.8	1.1	1.3	2.3	3	4.7
			25			0.8	1.1	1.3	2.3	3	4.7
		15	32				0.9	1.1	1.9	2.4	3.7
			40					1.1	1.9	2.4	3.7
			50						1.5	1.9	2.3
			63							1.7	2.3

		E. S800N										
L.	Char.	Icu [kA]	D									
			36									
			In [A]	25	32	40	50	63	80	100	125	
S200P	C	25	0.5	T	T	T	T	T	T	T	T	T
			1	T	T	T	T	T	T	T	T	T
			1.6	T	T	T	T	T	T	T	T	T
			2	T	T	T	T	T	T	T	T	T
			3	0.7	2.2	4.4	T	T	T	T	T	
			4	0.7	1.3	2.2	4.4	7.7	T	T	T	
			6	0.5	1	1.2	2	2.8	9.9	22	T	
			8	0.4	0.6	0.8	1.1	1.4	2.8	3.9	7.4	
			10	0.4	0.6	0.8	1.1	1.4	2.8	3.9	7.4	
			13	0.4	0.6	0.8	1.1	1.4	2.5	3.3	5.6	
			16		0.6	0.8	1.1	1.4	2.5	3.3	5.6	
			20			0.8	1.1	1.3	2.3	3	4.7	
			25			0.8	1.1	1.3	2.3	3	4.7	
			15	32				0.9	1.1	1.9	2.4	3.7
				40					1.1	1.9	2.4	3.7
				50						1.5	1.9	2.3
				63							1.7	2.3

E. = feed side

L. = load side

T = Total selectivity up to breaking capacity of the switch on load side

Selectivity limit values indicated in kA

MCBs technical details

Coordination tables: selectivity

		E.	S800N									
Char.		D										
L.	Icu [kA]	36										
		In [A]	25	32	40	50	63	80	100	125		
S200P	K	25	0.2	T	T	T	T	T	T	T	T	T
			0.3	T	T	T	T	T	T	T	T	T
			0.5	T	T	T	T	T	T	T	T	T
			0.75	T	T	T	T	T	T	T	T	T
			1	T	T	T	T	T	T	T	T	T
			1.6	T	T	T	T	T	T	T	T	T
			2	2.3	T	T	T	T	T	T	T	T
			3	0.7	1.3	4.4	T	T	T	T	T	T
			4	0.7	1	2.2	4.4	7.7	T	T	T	T
			6	0.6	0.8	1.5	2.5	3.6	12	24.2	T	
		8	0.5	0.7	1.1	1.5	2	4	5.5	9.9		
		10	0.5	0.7	1.1	1.5	2	4	5.5	9.9		
		13		0.6	0.9	1.2	1.5	2.6	3.4	5.2		
		16			0.9	1.2	1.5	2.6	3.4	5.2		
		20				0.9	1.1	1.8	2.2	3.2		
		25					1.1	1.8	2.2	3.2		
		15	32					1.7	2	2.9		
			40						1.9	2.6		
			50							2.2		
			63								2.2	

E. = feed side

L. = load side

T = Total selectivity up to breaking capacity of the switch on load side

Selectivity limit values indicated in kA

MCBs technical details

Coordination tables: selectivity

S800N – S400E/S450E @230/400V

Load s.	Char.	Supply s.		S800N									
		Icu [kA]	In [A]	B									
				36	25	32	40	50	63	80	100	125	
S400E S450E FS401E FS451E	B, C	Icn [kA] 6	6				0.4	0.5	0.6	0.9	1.4	2.4	
			10					0.4	0.5	0.7	0.9	1.3	
			13							0.5	0.7	0.9	1.2
			16								0.7	0.9	1.2
			20									0.9	1.2
			25									0.9	1.2
			32									0.7	1
			40									0.7	1
			50										0.9
63										0.9			

Load s.	Char.	Supply s.		S800N								
		Icu [kA]	In [A]	C								
				36	25	32	40	50	63	80	100	125
S400E S450E FS401E FS451E	B, C	Icn [kA] 6	6			0.4	0.5	0.6	0.9	1.3	2.2	4.4
			10			0.3	0.4	0.5	0.6	0.8	1.2	1.8
			13			0.3	0.4	0.5	0.6	0.8	1.2	1.7
			16			0.3	0.4	0.5	0.6	0.8	1.2	1.7
			20				0.4	0.5	0.6	0.8	1.1	1.6
			25				0.4	0.5	0.6	0.8	1.1	1.6
			32					0.4	0.5	0.7	0.9	1.3
			40						0.5	0.7	0.9	1.3
			50							0.7	0.9	1.2
63								0.8	1.1			

Load s.	Char.	Supply s.		S800N							
		Icu [kA]	In [A]	D							
				36	25	32	40	50	63	80	100
S400E S450E FS401E FS451E FS403E FS453E	B, C	Icn [kA] 6	6	0.5	0.9	1.1	1.8	2.5	T	T	T
			10	0.4	0.5	0.8	1	1.3	2.5	3.5	T
			13	0.4	0.5	0.8	1	1.3	2.3	3	5.1
			16		0.5	0.8	1	1.3	2.3	3	5.1
			20			0.7	1	1.2	2.1	2.7	4.3
			25			0.7	1	1.2	2.1	2.7	4.3
			32				0.9	1	1.7	2.2	3.4
			40					1	1.7	2.2	3.4
			50						1.4	1.7	2.1
63							1.6	2.1			

MCBs technical details

Coordination tables: selectivity

S800N – S400M @230/400V

Load s.	Char.	Supply s.		S800N								
		Icu [kA]	C									
			In [A]	25	32	40	50	63	80	100	125	
S400M S450M FS401M FS451M FS403M FS453M	B	Icn [kA] 10	6		0.4	0.5	0.6	0.9	1.3	2.2	4.4	
			10		0.3	0.4	0.5	0.6	0.8	1.2	1.8	
			13		0.3	0.4	0.5	0.6	0.8	1.2	1.7	
			16		0.3	0.4	0.5	0.6	0.8	1.2	1.7	
			20			0.4	0.5	0.6	0.8	1.1	1.6	
			25			0.4	0.5	0.6	0.8	1.1	1.6	
			32				0.4	0.5	0.6	0.8	1.1	1.6
			40					0.4	0.5	0.7	0.9	1.3
			50						0.5	0.7	0.9	1.3
			63							0.7	0.9	1.2
									0.8	1.1		

Load s.	Char.	Supply s.		S800S									
		Icu [kA]	C										
			In [A]	25	32	40	50	63	80	100	125		
S400M S450M FS401M FS451M FS403M FS453M	C	50	0.5	T	T	T	T	T	T	T	T	T	
			1	T	T	T	T	T	T	T	T	T	
			1.6	1	T	T	T	T	T	T	T	T	
			2	0	0.9	T	T	T	T	T	T	T	
		25	3	0	0.4	0.7	1.1	1.9	5.8	T	T	T	
			4	0	0.4	0.6	0.9	1.3	2.4	5.5	T	T	
			6		0.4	0.5	0.6	0.9	1.3	2.2	4.4	T	
			8		0.3	0.4	0.5	0.6	0.8	1.2	1.8	T	
			10		0.3	0.4	0.5	0.6	0.8	1.2	1.8	T	
			13		0.3	0.4	0.5	0.6	0.8	1.2	1.7	T	
			16		0.3	0.4	0.5	0.6	0.8	1.2	1.7	T	
			20			0.4	0.5	0.6	0.8	1.1	1.6	T	
			15	25			0.4	0.5	0.6	0.8	1.1	1.6	T
				32				0.4	0.5	0.7	0.9	1.3	T
				40					0.5	0.7	0.9	1.3	T
				50						0.7	0.9	1.2	T
		63								0.8	1.1	T	

MCBs technical details

Coordination tables: selectivity

S800N – S400M @230/400V

Load s.	Char.	Supply s.		S800N							
		Icu [kA]	In [A]	D							
				36	25	32	40	50	63	80	100
S400M S450M FS401M FS451M FS403M FS453M	B	Icn [kA] 10	6	0.5	0.9	1.1	1.8	2.5	9	T	T
			10	0.4	0.5	0.8	1	1.3	2.5	3.5	6.7
			13	0.4	0.5	0.8	1	1.3	2.3	3	5.5
			16		0.5	0.8	1	1.3	2.3	3	5.1
			20			0.7	1	1.2	2.1	2.7	4.3
			25			0.7	1	1.2	2.1	2.7	4.3
			32				0.9	1	1.7	2.2	3.4
			40					1	1.7	2.2	3.4
			50						1.4	1.7	2.1
			63							1.6	2.1

Load s.	Char.	Supply s.		S800N								
		Icu [kA]	In [A]	D								
				36	25	32	40	50	63	80	100	125
S400M S450M FS401M FS451M FS403M FS453M	C	50	0.5	T	T	T	T	T	T	T	T	T
			1	T	T	T	T	T	T	T	T	T
			1.6	T	T	T	T	T	T	T	T	T
			2	T	T	T	T	T	T	T	T	T
		25	3	0.7	2	4	T	T	T	T	T	T
			4	0.6	1.2	2	4	7	T	T	T	
			6	0.5	0.9	1.1	1.8	2.5	9	T	T	
			8	0.4	0.5	0.8	1	1.3	2.5	3.5	6.7	
			10	0.4	0.5	0.8	1	1.3	2.5	3.5	6.7	
			13	0.4	0.5	0.8	1	1.3	2.3	3	2.1	
			16		0.5	0.8	1	1.3	2.3	3	5.1	
			20			0.7	1	1.2	2.1	2.7	4.3	
		15	25			0.7	1	1.2	2.1	2.7	4.3	
			32				0.9	1	1.7	2.2	3.4	
			40					1	1.7	2.2	3.4	
			50						1.4	1.7	2.1	
			63							1.6	2.1	

MCBs technical details

Coordination tables: selectivity

Functional diagram of selective main circuit breakers S 750 (DR)

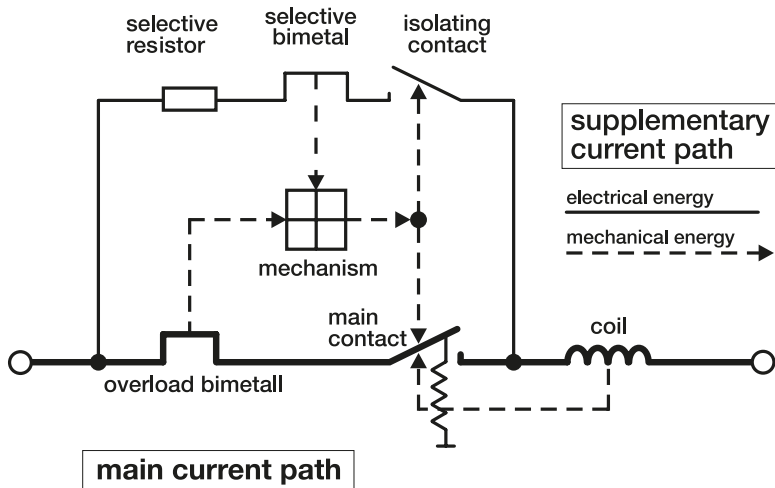

Back-up protection

Selective main circuit breakers of the S 750 DR series are capable of switching off short-circuit currents of up to 25 kA automatically in networks with a rated voltage of 230/400 V. Back-up protection is necessary only when the prospective short-circuit current may exceed 25 kA prosp. at the installation point. Further information on back-up protection on request.

Short circuit discrimination

When ABB miniature circuit-breaker are used in combination with the S 750 DR, higher short-circuit currents can be disconnected than indicated as permissible rated switching capacity of the device. Considering the values given in the table, the S 750 DR operates selectively with respect to the combination with the final device. If other MCBs are used selectivity for 6 kA and 10 kA devices is available up to the rated switching capacity of the final device.

MCBs technical details

Coordination tables: selectivity

Discrimination of S750 DR with respect to downstream MCB S200 / S400 compared to fuse protection

MCBs

supply side:		S750DR										fuse																			
final circuit:	Char.	I _{cu} [kA]	E / K																												
			I _n [A]	16	20	25	32	40	50	63	80	100	16	20	25	35	40	50	63	80	100										
S200 S400E	B, C	6	≤2	10	10	10	10	10	10	10	10	10	10	10	10	10	10	10	10	10	10	0.3	0.7	1.2	4.6	5	10	10	10	10	
			3	10	10	10	10	10	10	10	10	10	10	10	10	10	10	10	10	10	10	10	0.3	0.7	1.2	4.6	5	10	10	10	10
			4	10	10	10	10	10	10	10	10	10	10	10	10	10	10	10	10	10	10	10	0.3	0.6	0.9	2.8	3.5	6	10	10	10
			6	10	10	10	10	10	10	10	10	10	10	10	10	10	10	10	10	10	10	10	0.2	0.5	0.8	2	2.5	3.3	5.5	10	10
			8	10	10	10	10	10	10	10	10	10	10	10	10	10	10	10	10	10	10	10			0.7	1.5	2	2.5	3.5	5	6
			10	10	10	10	10	10	10	10	10	10	10	10	10	10	10	10	10	10	10	10			0.7	1.5	2	2.5	3.5	5	6
			13	10	10	10	10	10	10	10	10	10	10	10	10	10	10	10	10	10	10	10			0.7	1.5	2	2.5	3.5	5	6
			16		10	10	10	10	10	10	10	10	10	10	10	10	10	10	10	10	10	10				1.3	1.4	2	2.9	4.1	6
			20			10	10	10	10	10	10	10	10	10	10	10	10	10	10	10	10	10					0.7	1.8	2.6	3.5	5
			25				10	10	10	10	10	10	10	10	10	10	10	10	10	10	10	10					0.7	1.8	2.6	3.5	5
			32					10	10	10	10	10	10	10	10	10	10	10	10	10	10	10							2.2	3	4
			40						10	10	10	10	10	10	10	10	10	10	10	10	10	10							2.2	3	4
			50							10	10	10	10	10	10	10	10	10	10	10	10	10									3.5
63								10	10	10	10	10	10	10	10	10	10	10	10									3.5			

■ Limited overload selectivity

Discrimination of S750 DR with respect to downstream MCB S200 / S400 compared to fuse protection

MCBs

supply side:		S750DR										fuse																		
final circuit:	Char.	I _{cu} [kA]	E / K																											
			I _n [A]	16	20	25	32	40	50	63	80	100	16	20	25	35	40	50	63	80	100									
S200 S400E	K	6	≤2	10	10	10	10	10	10	10	10	10	10	10	10	10	10	10	10	10	10	0.3	1.2	4	6	10	10	10	10	10
			3	10	10	10	10	10	10	10	10	10	10	10	10	10	10	10	10	10	10	0.3	0.7	1.2	4.6	5	10	10	10	10
			4	10	10	10	10	10	10	10	10	10	10	10	10	10	10	10	10	10	10	0.3	0.6	0.9	2.8	3.5	6	10	10	10
			6	10	10	10	10	10	10	10	10	10	10	10	10	10	10	10	10	10	10			0.7	1.7	2.5	3	5.9	9	10
			8	10	10	10	10	10	10	10	10	10	10	10	10	10	10	10	10	10	10			0.4	0.8	1	1.7	2.5	4	6
			10	10	10	10	10	10	10	10	10	10	10	10	10	10	10	10	10	10	10			0.4	0.8	1	1.7	2.5	4	6
			16		10	10	10	10	10	10	10	10	10	10	10	10	10	10	10	10	10				0.7	0.9	1.2	2.2	3.1	4.6
			20			10	10	10	10	10	10	10	10	10	10	10	10	10	10	10	10					0.7	1.1	1.7	2.6	3.5
			25				10	10	10	10	10	10	10	10	10	10	10	10	10	10	10					0.7	1.1	1.7	2.6	3.5
			32					10	10	10	10	10	10	10	10	10	10	10	10	10	10							1.5	2.2	3.5
			40						10	10	10	10	10	10	10	10	10	10	10	10	10							1.5	2.2	3.5
			50							10	10	10	10	10	10	10	10	10	10	10	10									2.2
			63								10	10	10	10	10	10	10	10	10	10	10									2.2

■ Limited overload selectivity

MCBs technical details

Coordination tables: selectivity

Discrimination of S750 DR with respect to downstream MCB S200 / S400 compared to fuse protection

MCBs

final circuit:	supply side:		S750DR										fuse											
	Char.	E / K	I _{cu} [kA]										gG											
			25																					
			I _n [A]	16	20	25	32	40	50	63	80	100	16	20	25	35	40	50	63	80	100			
S200 S400E	Z	6	≤2	10	10	10	10	10	10	10	10	10	10	0.5	2	6	6	10	10	10	10	10		
			3	10	10	10	10	10	10	10	10	10	10	10	0.3	0.7	1.8	6	10	10	10	10	10	
			4	10	10	10	10	10	10	10	10	10	10	10	0.3	0.6	1.3	3.5	4	7	10	10	10	
			6	10	10	10	10	10	10	10	10	10	10	10	0.2	0.5	0.9	1.3	2.7	3.8	6	10	10	
			8	10	10	10	10	10	10	10	10	10	10	10		0.4	0.6	1.3	1.5	2.4	4	6	6	
			10	10	10	10	10	10	10	10	10	10	10	10		0.4	0.6	1.3	1.5	2.4	4	6	6	
			16		10	10	10	10	10	10	10	10	10	10			0.5	1.1	1.5	1.7	3	4.5	6	
			20			10	10	10	10	10	10	10	10	10					0.7	1.4	2	3	4.4	
			25				10	10	10	10	10	10	10	10					0.7	1.4	2	3	4.4	
			32					10	10	10	10	10	10	10								2	3	4
			40						10	10	10	10	10	10								2	3	4
			50							10	10	10	10	10										3
			63								10	10	10	10										3

■ Limited overload selectivity

MCBs technical details

Coordination tables: selectivity

Discrimination of S750 DR with respect to downstream MCB S200M / S400M compared to fuse protection

MCBs



supply side:		S750 DR										fuse														
final circuit:	Char.	I _{cu} [kA]	E / K										gG													
			I _n [A]	16	20	25	32	40	50	63	80	100	16	20	25	35	40	50	63	80	100					
S200M S400M	B, C	10	≤2	15	15	15	15	15	15	15	15	15	15	1	1.2	4	10	10	15	15	15	15				
			3	15	15	15	15	15	15	15	15	15	15	0.3	0.7	1.2	4.6	5	15	15	15	15				
			4	15	15	15	15	15	15	15	15	15	15	0.3	0.6	0.9	2.8	3.5	6	15	15	15	15			
			6	15	15	15	15	15	15	15	15	15	15	0.2	0.5	0.8	2	2.5	3.3	5.5	15	15				
			8	15	15	15	15	15	15	15	15	15	15			0.7	1.5	2	2.5	3.5	5	6				
			10	15	15	15	15	15	15	15	15	15	15			0.7	1.5	2	2.5	3.5	5	6				
			13	15	15	15	15	15	15	15	15	15	15			0.7	1.5	2	2.5	3.5	5	6				
			16		15	15	15	15	15	15	15	15	15					1.3	1.4	2	2.9	4.1	6			
			20			15	15	15	15	15	15	15	15						0.7	1.8	2.6	3.5	5			
			25				15	15	15	15	15	15	15						0.7	1.8	2.6	3.5	5			
			32					15	15	15	15	15	15									2.2	3	4		
			40						15	15	15	15	15									2.2	3	4		
			50							15	15	15	15													3.5
63								15	15	15													3.5			

■ Limited overload selectivity

Discrimination of S750 DR with respect to downstream MCB S200M / S400M compared to fuse protection

MCBs



supply side:		S750 DR										fuse														
final circuit:	Char.	I _{cu} [kA]	E / K										gG													
			I _n [A]	16	20	25	32	40	50	63	80	100	16	20	25	35	40	50	63	80	100					
S200M S400M	K	10	≤2	15	15	15	15	15	15	15	15	15	0.3	1.2	4	10	10	15	15	15	15					
			3	15	15	15	15	15	15	15	15	15	15	0.3	0.7	1.2	4.6	5	15	15	15	15				
			4	15	15	15	15	15	15	15	15	15	15	0.3	0.6	0.9	2.8	3.5	6	15	15	15	15			
			6	15	15	15	15	15	15	15	15	15	15			0.7	1.7	2.5	3	5.9	9	15				
			8	15	15	15	15	15	15	15	15	15	15			0.4	0.8	1	1.7	2.5	4	6				
			10	15	15	15	15	15	15	15	15	15	15			0.4	0.8	1	1.7	2.5	4	6				
			16		15	15	15	15	15	15	15	15	15					0.7	0.9	1.2	2.2	3.1	4.6			
			20			15	15	15	15	15	15	15	15						0.7	1.1	1.7	2.6	3.5			
			25				15	15	15	15	15	15	15						0.7	1.1	1.7	2.6	3.5			
			32					15	15	15	15	15	15									1.5	2.2	3.5		
			40						15	15	15	15	15									1.5	2.2	3.5		
			50							15	15	15	15													2.2
			63								15	15	15													2.2

■ Limited overload selectivity

MCBs technical details

Coordination tables: selectivity

Discrimination of S750 DR with respect to downstream MCB S200M / S400M compared to fuse protection

MCBs

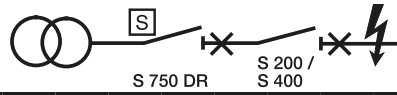

supply side:		S750DR										fuse										
final circuit:	Char.	E/K										gG										
		I _{cu} [kA]																				
		25																				
		I _n [A]	16	20	25	32	40	50	63	80	100	16	20	25	35	40	50	63	80	100		
S200M S400M	Z	10	≤2	15	15	15	15	15	15	15	15	15	0.5	2	10	10	15	15	15	15	15	
			3	15	15	15	15	15	15	15	15	15	0.3	0.7	1.8	6	15	15	15	15	15	
			4	15	15	15	15	15	15	15	15	15	0.3	0.6	1.3	3.5	4	7	15	15	15	
			6	15	15	15	15	15	15	15	15	15	0.2	0.5	0.9	1.3	2.7	3.8	6	15	15	
			8	15	15	15	15	15	15	15	15	15		0.4	0.6	1.3	1.5	2.4	4	6	6	
			10	15	15	15	15	15	15	15	15	15		0.4	0.6	1.3	1.5	2.4	4	6	6	
			16		15	15	15	15	15	15	15	15			0.5	1.1	1.5	1.7	3	4.5	6	
			20			15	15	15	15	15	15	15						0.7	1.4	2	3	4.4
			25				15	15	15	15	15	15						0.7	1.4	2	3	4.4
			32					15	15	15	15	15								2	3	4
			40						15	15	15	15								2	3	4
			50							15	15	15										3
			63								15	15										3

■ Limited overload selectivity

MCBs technical details

Coordination tables: selectivity

Discrimination of S750 DR with respect to downstream MCB S200P compared to fuse protection

MCBs

supply side:		S750 DR										fuse										
final circuit:	Char.	E/K										gG										
	I_{cu} [kA]	25																				
	I_n [A]	16	20	25	32	40	50	63	80	100	16	20	25	35	40	50	63	80	100			
S200P	B	25	6	25	25	25	25	25	25	25	25	0.2	0.4	0.6	1.3	2.5	3	5.5	12	25		
			10	25	25	25	25	25	25	25	25	25		0.6	1	1.5	1.8	2.5	3.7	5.5		
			13	25	25	25	25	25	25	25	25	25		0.6	1	1.5	1.8	2.5	3.7	5.5		
			16		25	25	25	25	25	25	25	25			1	1.4	1.6	2	3	5		
			20			25	25	25	25	25	25	25				0.7	1.5	2	3	4		
			25				25	25	25	25	25	25				0.7	1.5	2	3	4		
		15	32					15	15	15	15	15							1.9	2.7	3.5	
			40						15	15	15	15							1.9	2.7	3.5	
			50							15	15	15								2.7	3.4	
			63								15	15								2.7	3.4	

■ Limited overload selectivity

Discrimination of S750 DR with respect to downstream MCB S200P compared to fuse protection

MCBs

supply side:		S750 DR										fuse											
final circuit:	Char.	E/K										gG											
	I_{cu} [kA]	25																					
	I_n [A]	16	20	25	32	40	50	63	80	100	16	20	25	35	40	50	63	80	100				
S200P	C	25	≤2	25	25	25	25	25	25	25	25	0.3	0.8	1.5	6	10	25	25	25	25			
			3	25	25	25	25	25	25	25	25	25	0.3	0.8	1.5	6	10	25	25	25	25		
			4	25	25	25	25	25	25	25	25	25	0.3	0.6	1	3.3	4	6	25	25	25		
			6	25	25	25	25	25	25	25	25	25	0.2	0.4	0.6	1.3	2.5	3	5.5	12	25		
			8	25	25	25	25	25	25	25	25	25			0.6	1	1.5	1.8	2.5	3.7	5.5		
			10	25	25	25	25	25	25	25	25	25			0.6	1	1.5	1.8	2.5	3.7	5.5		
			13	25	25	25	25	25	25	25	25	25			0.6	1	1.5	1.8	2.5	3.7	5.5		
			16		25	25	25	25	25	25	25	25				1	1.4	1.6	2	3	5		
			20			25	25	25	25	25	25	25					0.7	1.5	2	3	4		
			25				25	25	25	25	25	25					0.7	1.5	2	3	4		
			15	32					15	15	15	15	15								1.9	2.7	3.5
				40						15	15	15	15								1.9	2.7	3.5
				50							15	15	15									2.7	3.4
				63								15	15									2.7	3.4

■ Limited overload selectivity

MCBs technical details

Coordination tables: selectivity

Discrimination of S750 DR with respect to downstream MCB S200P compared to fuse protection

MCBs

supply side:		S750 DR										fuse									
final circuit:	Char.	E/K										gG									
		I_{cu} [kA]	25																		
		I_n [A]	16	20	25	32	40	50	63	80	100	16	20	25	35	40	50	63	80	100	
S200P	K	25	≤2	25	25	25	25	25	25	25	25	25	0.3	0.8	1.5	6	7.5	25	25	25	25
			3	25	25	25	25	25	25	25	25	25	0.3	0.8	1.5	6	7.5	25	25	25	25
			4	25	25	25	25	25	25	25	25	25	0.3	0.6	1	3.3	3.5	6	25	25	25
			6	25	25	25	25	25	25	25	25	25			0.6	1.3	1.5	3	5.5	9	25
			8	25	25	25	25	25	25	25	25	25			0.4	0.8	1	1.6	2.2	3.2	5.5
			10	25	25	25	25	25	25	25	25	25			0.4	0.8	1	1.6	2.2	3.2	5.5
			13	25	25	25	25	25	25	25	25	25			0.4	0.8	1	1.6	2.2	3.2	5.5
			16		25	25	25	25	25	25	25	25				0.7	0.9	1.5	2	3	5
			20			25	25	25	25	25	25	25					0.7	1.1	1.7	2.5	3.5
		25				25	25	25	25	25	25					0.7	1.1	1.7	2.5	3.5	
		15	32					15	15	15	15	15							1.5	2.2	3.1
		40							15	15	15	15							1.5	2.2	3.1
		50								15	15	15									2.2
63									15	15									2.2		

Limited overload selectivity

Discrimination of S750 DR with respect to downstream MCB S200P compared to fuse protection

MCBs

supply side:		S750 DR										fuse									
final circuit:	Char.	E/K										gG									
		I_{cu} [kA]	25																		
		I_n [A]	16	20	25	32	40	50	63	80	100	16	20	25	35	40	50	63	80	100	
S200P	Z	25	≤2	25	25	25	25	25	25	25	25	25	0.3	0.6	1.8	4	25	25	25	25	25
			3	25	25	25	25	25	25	25	25	25	0.3	0.6	1.8	4	25	25	25	25	25
			4	25	25	25	25	25	25	25	25	25	0.3	0.6	0.8	2.5	4	7	25	25	25
			6	25	25	25	25	25	25	25	25	25			0.6	1.3	2	2.8	6	25	25
			8	25	25	25	25	25	25	25	25	25			0.4	0.8	1.2	1.5	2.3	3.7	6
			10	25	25	25	25	25	25	25	25	25			0.4	0.8	1.2	1.5	2.3	3.7	6
			16		25	25	25	25	25	25	25	25				0.7	0.9	1.5	1.9	2.9	4.5
			20			25	25	25	25	25	25	25					0.7	1.3	2	2.8	4.4
			25				25	25	25	25	25	25					0.7	1.3	2	2.8	4.4
		15	32					15	15	15	15	15							1.8	2.7	4
		40							15	15	15	15							1.8	2.7	4
		50								15	15	15									3
		63									15	15									3

Limited overload selectivity

MCBs technical details

Coordination tables: selectivity

Short-circuit discrimination (in kA) apply for combinations¹⁾: fuse gL/gG – S 750 DR – S 200/S 400 E



fuse:		63A gG					80A gG					100A gG						
supply side:		S 750 DR																
final circuit:	Char.	I _{cu} [kA]	E/K															
			I _n [A]	25					25					25				
				32	40	50	63	32	40	50	63	80	32	40	50	63	80	100
S 200 S 400 E	B, C, D, K, Z	6	≤2	15	15	15	15	15	15	15	15	15	15	15	15	15	15	15
			3	10	10	10	10	10	10	10	10	10	10	10	10	10	10	10
			4	10	10	10	10	10	10	10	10	10	10	10	10	10	10	10
			6	10	10	10	10	10	10	10	10	10	10	10	10	10	10	10
			8	7	6	6	5	10	10	10	8	7	10	10	10	10	10	10
			10	7	6	6	5	10	10	10	8	7	10	10	10	10	10	10
			13	6	6	6	5	9	8	8	7	6	10	10	10	10	10	10
			16	6	6	6	5	9	8	8	7	6	10	10	10	10	9	8
			20	5	5	4.5	4.5	6	7	7	6.5	5.5	10	10	10	10	9	8
			25		4.5	4.5	4		7	6	6	5.5		10	10	10	9	8
			32			4	3.5			6	5.5	5			9	9	8	7
			40				3				5	4				8	7	6
			50									2					5	4
63															4			

¹⁾ The selectivity limit current I_{s1} results from the let-through I^2t -value of S 750 DR plus S 200/S 400 and the pre-arcing (melting) I^2t -value of a fuse acc. to IEC/EN 60269

Short-circuit discrimination (in kA) apply for combinations¹⁾: fuse gL/gG – S 750 DR – S 200/S 400 E



fuse:		125A gG					160A gG													
supply side:		S 750 DR																		
final circuit:	Char.	I _{cu} [kA]	E/K																	
			I _n [A]	25					25					25						
				32	40	50	63	80	100	32	40	50	63	80	100	32	40	50	63	80
S 200 S 400 E	B, C, D, K, Z	6	≤2	15	15	15	15	15	15	15	15	15	15	15	15	15	15	15	15	15
			3	10	10	10	10	10	10	10	10	10	10	10	10	10	10	10	10	10
			4	10	10	10	10	10	10	10	10	10	10	10	10	10	10	10	10	10
			6	10	10	10	10	10	10	10	10	10	10	10	10	10	10	10	10	10
			8	10	10	10	10	10	10	10	10	10	10	10	10	10	10	10	10	10
			10	10	10	10	10	10	10	10	10	10	10	10	10	10	10	10	10	10
			13	10	10	10	10	10	10	10	10	10	10	10	10	10	10	10	10	10
			16	10	10	10	10	10	10	10	10	10	10	10	10	10	10	10	10	10
			20	10	10	10	10	10	10	10	10	10	10	10	10	10	10	10	10	10
			25		10	10	10	10	10	10			10	10	10	10	10	10	10	
			32			10	10	10	10	10				10	10	10	10	10	10	
			40				10	10	10	10					10	10	10	10	10	
			50					10	10	10						10	10	10	10	
63						9											10			

¹⁾ The selectivity limit current I_{s1} results from the let-through I^2t -value of S 750 DR plus S 200/S 400 and the pre-arcing (melting) I^2t -value of a fuse acc. to IEC/EN 60269

MCBs technical details

Coordination tables: selectivity

Short-circuit discrimination (in kA) apply for combinations¹⁾: fuse gL/gG – S 750 DR – S200M / S400M



fuse:		63A gG				80A gG					100A gG							
supply side:		S 750 DR																
final circuit:	Char.	I _{cu} [kA]	E/K															
			I _n [A]	25														
				32	40	50	63	32	40	50	63	80	32	40	50	63	80	100
S 200M S 400M	B, C, D, K, Z	6	≤2	15	15	15	15	15	15	15	15	15	15	15	15	15	15	
			3	15	15	15	15	15	15	15	15	15	15	15	15	15	15	
			4	15	15	15	15	15	15	15	15	15	15	15	15	15	15	
			6	10	10	10	10	15	15	15	14	14	15	15	15	15	15	15
			8	7	6	6	5	10	10	10	8	7	15	15	15	15	15	14
			10	7	6	6	5	10	10	10	8	7	15	15	15	15	15	14
			13	6	6	6	5	9	8	8	7	6	10	10	10	10	15	14
			16	6	6	6	5	9	8	8	7	6	10	10	10	10	9	8
			20	5	5	4.5	4.5	6	7	7	6.5	5.5	10	10	10	10	9	8
			25		4.5	4.5	4		7	6	6	5.5		10	10	10	9	8
			32			4	3.5			6	5.5	5			9	9	8	7
			40				3				5	4				8	7	6
			50									2					5	4
63															4			

¹⁾ The selectivity limit current I_{s1} results from the let-through I^2t -value of S750 DR plus S200M / S400M and the pre-arcing (melting) I^2t -value of a fuse acc. to IEC / EN 60269

Short-circuit discrimination (in kA) apply for combinations¹⁾: fuse gL/gG – S 750 DR – S200M / S400M



fuse:		125A gG						160A gG							
supply side:		S 750 DR													
final circuit:	Char.	I _{cu} [kA]	E/K												
			I _n [A]	25											
				32	40	50	63	80	100	32	40	50	63	80	100
S 200M S 400M	B, C, D, K, Z	6	≤2	15	15	15	15	15	15	15	15	15	15	15	15
			3	15	15	15	15	15	15	15	15	15	15	15	15
			4	15	15	15	15	15	15	15	15	15	15	15	15
			6	15	15	15	15	15	15	15	15	15	15	15	15
			8	15	15	15	15	15	15	15	15	15	15	15	15
			10	15	15	15	15	15	15	15	15	15	15	15	15
			13	15	15	15	15	15	15	15	15	15	15	15	15
			16	15	15	15	15	15	15	15	15	15	15	15	15
			20	15	15	15	15	15	15	15	15	15	15	15	15
			25		15	15	15	15	15	12		15	15	15	15
			32			15	15	15	12			15	15	15	15
			40				14	12	10				15	15	15
			50					10	10					15	15
63						9						15			

¹⁾ The selectivity limit current I_{s1} results from the let-through I^2t -value of S750 DR plus S200M / S400M and the pre-arcing (melting) I^2t -value of a fuse acc. to IEC / EN 60269

MCBs technical details

Coordination tables: selectivity

Short-circuit discrimination (in kA) apply for combinations¹⁾: fuse gL/gG – S 750 DR – S 200 P



fuse:		63A gG					80A gG					100A gG						
supply side:		S 750 DR																
final circuit:	Char.	I_{cu} [kA]	E/K															
			I_n [A]	25					25					25				
S 200 P	B, C, D, K, Z	25	≤ 2	32	40	50	63	32	40	50	63	80	32	40	50	63	80	100
			≤ 2	15	15	15	15	25	25	25	25	25	25	25	25	25	25	25
			3	10	10	10	10	25	25	15	15	25	25	25	25	25	25	25
			4	10	10	10	10	20	20	15	15	15	25	25	25	25	25	25
			6	10	10	10	10	17	16	15	14	14	25	25	20	20	20	20
			8	7	6	6	5	10	10	10	8	7	20	20	15	15	15	14
			10	7	6	6	5	10	10	10	8	7	20	15	15	15	15	14
			13	6	6	6	5	9	8	8	7	6	15	15	15	15	15	14
			16	6	6	6	5	9	8	8	7	6	12	12	10	10	9	8
		20	5	5	4.5	4.5	6	7	7	6.5	5.5	12	12	10	10	9	8	
		15	25		4.5	4.5	4		7	6	6	5.5		10	10	10	9	8
			32			4	3.5			6	5.5	5			10	10	8	7
			40				3				5	4				9	7	6
			50									2					5	4
			63															4

¹⁾ The selectivity limit current I_{sl} results from the let-through I^2t -value of S 750 DR plus S 200 P and the pre-arcing (melting) I^2t -value of a fuse acc. to IEC / EN 60269

Short-circuit discrimination (in kA) apply for combinations¹⁾: fuse gL/gG – S 750 DR – S 200 P



fuse:		125A gG					160A gG														
supply side:		S 750 DR																			
final circuit:	Char.	I_{cu} [kA]	E/K																		
			I_n [A]	25					25					25							
S 200 P	B, C, D, K, Z	25	≤ 2	32	40	50	63	80	100	32	40	50	63	80	100	32	40	50	63	80	100
			≤ 2	25	25	25	25	25	25	25	25	25	25	25	25	25	25	25	25	25	25
			3	25	25	25	25	25	25	25	25	25	25	25	25	25	25	25	25	25	25
			4	25	25	25	25	25	25	25	25	25	25	25	25	25	25	25	25	25	25
			6	25	25	25	25	25	25	25	25	25	25	25	25	25	25	25	25	25	25
			8	25	25	25	25	25	25	25	25	25	25	25	25	25	25	25	25	25	25
			10	25	25	25	25	25	20	25	25	25	25	25	25	25	25	25	25	25	25
			13	22	22	20	20	20	18	22	22	20	20	20	25	25	25	25	25	25	25
			16	22	22	20	18	18	15	22	22	20	18	25	25	25	25	25	25	25	25
		20	20	20	20	18	18	15	20	20	20	18	25	25	25	25	25	25	25	25	
		15	25		15	15	15	15	12		15	15	15	15	15		15	15	15	15	15
			32			15	15	15	12			15	15	15	15			15	15	15	15
			40				15	12	10				15	15	15				15	15	15
			50					10	10					15	15					15	15
			63						9						15						15

¹⁾ The selectivity limit current I_{sl} results from the let-through I^2t -value of S 750 DR plus S 200 P and the pre-arcing (melting) I^2t -value of a fuse acc. to IEC / EN 60269

MCBs technical details

MCBs internal resistance, power loss and max. permissible earth-fault loop impedance

Internal resistance and power loss of the miniature circuit-breakers

Internal resistance per pole in mΩ, power loss per pole in W

Type	Rated current I_n A	Device series (internal resistance and power loss per device) B, C, D	
		mΩ	W
SN201 L	2	520	2.1
SN201	4	147.5	2.4
SN201 M	6	64	2.3
	10	19	1.9
	16	14	3.6
	20	12	4.8
	25	7.1	4.4
	32	6.5	6.7
	40	4.7	7.5

Power losses S200C series (per device)

I_n (A)	1P+1P (W)	2P (W)	3P (W)	4P (W)
2	2.2	2.2	3.3	4.4
4	2.7	2.7	4.0	5.4
6	3.0	3.0	4.6	6.1
10	3.3	3.3	4.9	6.6
13	3.8	3.8	NA	NA
15	NA	3.9	NA	NA
16	4.2	4.2	6.3	8.4
20	5.0	5.0	7.6	10.1
25	NA	6.2	9.3	12.4
32	NA	7.6	11.4	15.2
40	NA	8.9	NA	NA

Type	Rated current I_n A	Device series							
		B, C ①		D		K		Z	
		mΩ	W	mΩ	W	mΩ	W	mΩ	W
S 200 and S 200 M	0.5	5500	1.4	4300	1.1	4300	1.1	8100	2.4
	1	1440	1.4	1250	1.25	1250	1.25	2100	2.3
	1.6	630	1.6	600	1.5	600	1.5	1000	2.8
	2	460	1.8	410	1.65	410	1.65	619	2.5
	3	150	1.3	130	1.2	130	1.2	235	2.4
	4	110	1.8	105	1.7	105	1.7	149	2.4
	6	55	2.0	52	1.9	52	1.9	75	3.2
	8	23	1.5	24	1.5	24	1.5	27	2.0
	10	19	2.1	16	1.6	13.5	1.4	24	2.7
	13	14	2.3	14	2.2	13.5	1.4	–	–
	16	8.5	2.5	8.5	2.5	7.7	2.0	10.9	2.8
	20	6.25	2.5	6.1	2.3	6.7	2.7	6.0	2.4
	25	5.0	3.2	4.3	3.1	4.6	2.9	4.5	3.3
	32	3.6	3.7	3.5	3.6	3.5	3.6	3.5	3.6
40	3.0	4.8	2.2	4.2	2.8	4.5	2.5	4.1	
50	1.3	3.25	1.25	2.9	1.25	3.1	1.5	4.1	
63	1.2	4.8	1.2	4.8	1.0	4.4	1.3	5.2	

① Current intensities 0.5 – 4 apply exclusively to C-type trip characteristics.

MCBs technical details

MCBs internal resistance, power loss and max. permissible earth-fault loop impedance

Internal resistance and power loss of the miniature circuit-breakers

Internal resistance per pole in mΩ, power loss per pole in W

Type	Rated current I_n A	Device series					
		B, C, D ①		K		Z	
		mΩ	W	mΩ	W	mΩ	W
S 200 P	0.2	–	–	42500	1.7	–	–
	0.3	–	–	20000	1.8	–	–
	0.5	5500	1.4	6340	1.6	10100	2.5
	0.75	–	–	2500	1.4	–	–
	1	1440	1.4	1400	1.4	2270	2.3
	1.6	630	1.6	625	1.6	1100	2.8
	2	460	1.8	460	1.8	619	2.5
	3	211	1.9	211	1.9	211	1.9
	4	150	2.4	163	2.6	163	2.6
	6	61	2.2	67	2.4	104	3.7
	8	45	2.9	45	2.9	55	3.5
	10	14	1.4	19	1.9	21	2.1
	13	13.3	2.3	–	–	–	–
	16	9.7	2.5	8.2	2.1	10.9	2.8
	20	7.3	2.9	7.3	2.9	7.3	2.9
	25	5.6	3.5	5.6	3.5	5.6	3.5
	32	4.1	4.2	4.1	4.2	4.1	4.2
	40	4.0	6.4	4.0	6.4	4.0	6.4
50	1.2	3.0	1.2	3.0	1.8	4.4	
63	1.4	5.6	1.3	5.2	1.3	5.2	

① Current intensities 0.5 – 4 apply exclusively to C-type trip characteristics.

MCBs technical details

MCBs internal resistance, power loss and max. permissible earth-fault loop impedance

Internal resistance and power loss per pole

Internal resistance in mΩ per pole in cold state, power loss in W per pole at rated current

Type	Tripping characteristics	Rated current	R_i	P_{Vmax}
		A	mΩ	W
S 200 S	B, C	6	52.1	2.16
	C	8	22.9	1.65
	B, C	10	19.0	2.20
	B, C	13	13.7	2.62
	B, C	16	9.1	3.28
	B, C	20	6.2	3.14

SU200 M

Rated current	C, K characteristics		Z characteristics	
	Internal resistance per pole	Power loss	Internal resistance per pole	Power loss
I_n	R_i	P_v	R_i	P_v
A	mΩ	W	mΩ	W
0.2	42500	1.7	-	-
0.3	18889	1.7	-	-
0.5	5600	1.4	9000	2.3
0.75	2489	1.4	-	-
1	1400	1.4	2200	2.2
1.6	703	1.8	1000	2.6
2	450	1.8	650	2.6
3	178	1.6	250	2.3
4	113	1.8	140	2.2
5	50	1.3	100	2.5
6	56	2.0	70	2.5
8	23	1.5	28	1.8
10	21	2.1	21	2.1
13	14	2.3	17	2.9
15	11	2.4	13	2.9
16	9.8	2.5	10	2.6
20	6.3	2.5	6.5	2.6
25	5.1	3.2	5.1	3.2
30	3.9	3.5	3.9	3.5
32	3.6	3.7	3.6	3.7
35	3.3	4.1	3.3	4.1
40	2.8	4.5	2.8	4.5
50	1.8	4.5	1.8	4.5
60	1.4	4.9	1.4	4.9
63	1.4	5.4	1.4	5.4

MCBs technical details

MCBs internal resistance, power loss and max. permissible earth-fault loop impedance

S200 80-100A

Tripping characteristic	Rated current	Internal resistance	Power loss
	I_n	R_i	P_v
	A	mΩ	W
B, C	80	0.9	8.1
B, C	100	0.8	9.8

Rated current I_n/A	S750DR E		S750DR K	
	Internal resistance ¹ $R_i/m\Omega$	Power loss ² P_v/W	Internal resistance ¹ $R_i/m\Omega$	Power loss ² P_v/W
16	15.3	4.1	14.5	3.9
20	11.3	5.4	10.7	5.1
25	8.7	5.9	8.3	5.5
35	4.5	6.3	4.3	6.2
40	3.4	6.1	3.2	5.8
50	2.9	7.6	2.8	7.2
63	2.1	8.7	2.1	8.7
80	1.6	10.5	1.6	10.5
100	1.3	12.0	1.3	12.0

¹in cold state ²at rated current

S800PV-SP, S800PV-SD and S800PV-M-H

Typical internal resistances and power losses at 25 °C ambient temperature (per pole)

Rated current $I_n [A]$	Internal resistance $R_i [m\Omega]$			Power loss $P_v [W]$		
	PV-SP	PV-SD	PV-M-H	PV-SP	PV-SD	PV-M-H
5	57.9			1.5		
6	51.7			1.8		
8	27.2			1.7		
10	15.2			1.5		
13	12.1			2.0		
16	12.1			3.1		
20	8.7			3.5		
25	6.8			4.3		
32	3.1	1.8	1.8	3.2	1.8	1.8
40	2.3			3.7		
50	1.7			4.3		
63	1.6	0.9	0.9	6.4	3.6	3.6
80	1.0			6.4		
100	0.8			8.0		
125	0.6	0.5	0.6	9.4	7.8	6.0

MCBs technical details

MCBs internal resistance, power loss and max. permissible earth-fault loop impedance

S800S - S800N - S800C - S800HV

Typical internal resistances and power losses at 25 °C ambient temperature (per pole)

Rated current I_n [A]	Internal resistance R_i [mΩ]			Power loss P_v [W]		
	B, C, D, K ①	KM ②	UCB, UCK ②	B, C, D, K	KM ②	UCB, UCK ②
0.5	8124.6	-	8124.6	2	-	2
1	1627.2	-	1627.2	1.6	-	1.6
1.6	1118.6	-	1118.6	2.9	-	2.9
2	556.6	-	556.6	2.2	-	2.2
2.5	399.3	-	399.3	2.5	-	2.5
3	270.3	-	270.3	2.4	-	2.4
4	126.4	-	126.4	2	-	2
5	57.9	-	57.9	1.5	-	1.5
6	51.7	-	51.7	1.8	-	1.8
8	27.2	-	27.2	1.7	-	1.7
10	15.2	2.7	15.2	1.5	0.27	1.5
13	12.1	-	12.1	2	-	2
16	12.1	2.7	12.1	3.1	0.69	3.1
20	8.7	2.7	8.7	3.5	1.1	3.5
25	6.8	3	6.8	4.3	1.9	4.3
32	3.1	1.7	3.1	3.2	1.7	3.2
40	2.3	1.6	2.3	3.7	2.6	3.7
50	1.7	1.1	1.7	4.3	2.8	4.3
63	1.6	1	1.6	6.4	4	6.4
80	1	0.75	1	6.4	5	6.4
100	0.8	-	0.8	8	-	8
125	0.6	-	0.6	9.4	-	9.4

① K Applicable only for S800S, S800C, S800HV ② KM, UCB, UCK Applicable only for S800S

S800B

Typical internal resistances and power losses at 25 °C ambient temperature (per pole)

Rated current I_n [A]	Internal resistance R_i [mΩ]		Power loss P_v [W]	
	B, C	D, K	B, C	D, K
32	3.1	3.1	3.2	3.2
40	2.3	2.3	3.7	3.7
50	1.7	1.7	4.3	4.3
63	1.6	1.6	6.4	6.4
80	1.0	1.0	6.4	6.4
100	0.8	0.8	8.0	8.0
125	0.7	0.7	10.9	10.9

S800U

Typical internal resistances and power losses at 25 °C ambient temperature (per pole)

Rated current I_n [A]	Internal resistance R_i [mΩ]	Power loss P_v [W]
	K, Z	K, Z
10	15.2	1.5
15	12.1	2.7
20	8.7	3.5
25	6.8	4.2
30	3.1	2.8
40	2.3	3.7
50	1.7	4.3
60	1.6	5.8
70	1.0	4.9
80	1.0	6.4
90	0.8	6.5
100	0.8	8.3

MCBs technical details

MCBs internal resistance, power loss and max. permissible earth-fault loop impedance

S800S - S800N - S800C

Maximum permissible earth-fault loop impedance Z_s at U_o 230 V* to ensure compliance with the requirements of IEC 60364-4.

The instantaneous release of the MCB ensures an operating time of max. 0.1s (TN system). Determined according to IEC 60364-5-52 / VDE 0100-520 and DIN VDE 0100-520 sheet 2:2002 (source impedance 300mW, $c = 0.95$ and conductor temperature 70°C = factor 0.8). The internal resistance of the MCB is included. Values below 10 A are available upon request.

* U_o : rated voltage against earthed conductor; for U_o : AC 240 V multiply Z_s by 1.04, for U_o : AC 254 V multiply Z_s by 1.10, for U_o : AC 400 V multiply Z_s by 1.74

Rated current (A)	B	C max. Z_s (Ω)	D	K
10	4.8	2.4	1.5	1.5
13	3.7	1.8	1.1	1.1
16	3.0	1.5	0.9	0.9
20	2.4	1.2	0.7	0.7
25	1.9	1.0	0.6	0.6
32	1.5	0.7	0.5	0.5
40	1.2	0.6	0.4	0.4
50	1.0	0.5	0.3	0.3
63	0.8	0.4	0.2	0.2
80	0.6	0.3	0.2	0.2
100	0.5	0.2	0.1	0.1
125	0.4	0.2	0.1	0.1

MCBs technical details

MCBs internal resistance, power loss and max. permissible earth-fault loop impedance

Maximum permissible earth-fault loop impedance Z_S at $U_0 = 230\text{ V} \sim b$ to ensure compliance with the operation conditions pursuant to IEC 60364-4.

Operating time $< 0.4\text{ s}$; at $400\text{ V} \sim < 0.2\text{ s}$ and at $> 400\text{ V} \sim < 0.1\text{ s}$ The instantaneous release of the MCB ensures an operating time of $\leq 0.1\text{ s}$ (TN system).

Determined according to DIN VDE 0100-520 sheet 2:2002-11(source impedance = $300\text{ m}\Omega$ and conductor temperature $70\text{ }^\circ\text{C}$. The internal resistance of the MCB is already considered.

S 200 and S 200 M

Rated current I_n A	B	C	D	K	Z
	max. Z_S	max. Z_S	max. Z_S	max. Z_S	max. Z_S
	q	q	q	q	q
0.5	-	40.4	18.5	28.4	145.6
1	-	21.4	10.0	14.9	74.6
1.6	-	13.5	6.3	9.4	46.8
2	-	10.8	5.1	7.5	37.6
3	-	7.2	3.4	5.1	25.1
3	-	7.2	3.4	5.1	25.1
4	-	5.4	2.5	3.7	18.8
6	7.3	3.5	1.6	2.4	12.5
8	5.5	2.6	1.1	1.7	9.3
10	4.3	2.0	0.8	1.3	7.4
13	3.2	1.5	0.6	1.0	-
16	2.6	1.1	0.4	0.7	4.5
20	2.0	0.8	0.3	0.5	3.5
25	1.5	0.6	0.2	0.4	2.8
32	1.1	0.4	0.1	0.2	2.1
40	0.9	0.3	0.0	0.1	1.6
50	0.6	0.2	0.0	0.0	1.2
63	0.4	0.1	0.0	0.0	0.9

b U_0 = rated voltage against earthed conductor; for $U_0 = 240\text{ V} \sim$ is $Z_S \cdot 1.04$; for $U_0 = 127\text{ V} \sim$ is $Z_S \cdot 0.55$

MCBs technical details

Performances at different ambient temperatures, altitudes and frequencies

S 200 P

Rated current I_n A	B	C	D	K	Z
	max. ZS	max. ZS	max. ZS	max. ZS	max. ZS
	q	q	q	q	q
0.2	–	–		39.5	–
0.3	–	–		34.8	–
0.5	–	46	27.4	26.5	143
0.75	–	–		19.4	–
1	–	23	15	15	74.4
1.6	–	14.4	9.6	9.6	47.9
2	–	11.5	7.8	7.8	38.3
3	–	7.7	11.8	5.3	25.3
4	–	5.8	8.8	3.9	19.1
6	7.6	3.8	5.9	2.6	12.7
8	–	2.8	5.7	2.0	9.5
10	4.6	2.3	3.5	1.6	7.6
13	3.5	1.7	2.7	1.3	–
16	2.9	1.4	2.2	1.0	4.7
20	2.3	1.1	1.7	0.8	3.8
25	1.8	0.9	1.4	0.6	3.0
32	1.4	0.7	1.1	0.5	2.4
40	1.1	0.6	0.9	0.4	1.9
50	0.9	0.5	0.7	0.3	1.5
63	0.7	0.4	0.6	0.25	1.1

b U_0 = rated voltage against earthed conductor; for $U_0 = 240\text{ V}$ is $ZS \cdot 1.04$; for $U_0 = 127\text{ V}$ is $ZS \cdot 0.55$

Take into account the voltage drop:

e.g. in the case of a 1.5 mm^2 conductor, protected by a B 16 circuit-breaker, the maximum cable length is 82 m. If the voltage drop is below 3%, this would result in a maximum cable length (2-strand) of 17 m. For more details on this topic, get your own copy of the technical information leaflet "Maximum cable lengths".

Maximum cable lengths in the case of different voltages and cross sections on request.

Miniature Circuit breakers S300P

Derating

For installations of miniature circuit breakers at other temperatures than the reference value and installations of several miniature circuit breakers directly side by side, derating factors have to be considered.

Deviating ambient temperature

The rated value of the current of a miniature circuit breaker refers to a temperature of 40 °C for circuit-breakers with characteristics K and Z and 30 °C for characteristics B, C and D. The following table contains the derating of load capability of S300P MCBs with temperature from -40 °C to 70 °C for the curves B, C, D, K, and Z.

Tripping characteristics	Rated Current In (A)	Max. Operating currents depending on the ambient temperature T (°C)											
		-40	-30	-20	-10	0	10	20	30	40	50	60	70
B, C and D	0,5	0,6	0,6	0,6	0,6	0,5	0,5	0,5	0,5	0,5	0,5	0,5	0,4
	1	1,2	1,2	1,2	1,1	1,1	1,1	1,0	1,0	1,0	0,9	0,9	0,9
	1,6	1,9	1,9	1,8	1,8	1,7	1,7	1,6	1,6	1,6	1,5	1,5	1,4
	2	2,4	2,4	2,3	2,2	2,2	2,1	2,1	2,0	1,9	1,9	1,8	1,8
	3	3,6	3,5	3,5	3,4	3,3	3,2	3,1	3,0	2,9	2,8	2,7	2,6
	4	4,8	4,7	4,6	4,5	4,4	4,2	4,1	4,0	3,9	3,8	3,6	3,5
	6	7,3	7,1	6,9	6,7	6,5	6,4	6,2	6,0	5,8	5,6	5,5	5,3
	8	9,7	9,4	9,2	9,0	8,7	8,5	8,2	8,0	7,8	7,5	7,3	7,0
	10	12,1	11,8	11,5	11,2	10,9	10,6	10,3	10,0	9,7	9,4	9,1	8,8
	13	15,5	15,5	15,0	14,5	14,0	14,0	13,5	13,0	12,5	12,0	12,0	11,5
	16	19,5	19,0	18,5	18,0	17,5	17,0	16,5	16,0	15,5	15,0	14,5	14,0
	20	24,0	23,5	23,0	22,5	22,0	21,0	20,5	20,0	19,5	19,0	18,0	17,5
	25	30,5	29,5	29,0	28,0	27,5	26,5	26,0	25,0	24,5	23,5	23,0	22,0
	32	38,5	38,0	37,0	36,0	35,0	34,0	33,0	32,0	31,0	30,0	29,0	28,0
40	48,5	47,0	46,0	45,0	43,5	42,5	41,0	40,0	39,0	37,5	36,5	35,0	
50	60,5	59,0	57,5	56,0	54,5	53,0	51,5	50,0	48,5	47,0	45,5	44,0	
63	76,0	74,5	72,5	70,5	68,5	67,0	65,0	63,0	61,0	59,0	57,5	55,5	
K and Z	0,2	0,3	0,3	0,2	0,2	0,2	0,2	0,2	0,2	0,2	0,2	0,2	
	0,3	0,4	0,4	0,4	0,4	0,3	0,3	0,3	0,3	0,3	0,3	0,3	
	0,5	0,7	0,6	0,6	0,6	0,6	0,6	0,5	0,5	0,5	0,5	0,4	
	0,75	1,0	1,0	0,9	0,9	0,9	0,8	0,8	0,8	0,8	0,7	0,7	
	1	1,3	1,3	1,2	1,2	1,2	1,1	1,1	1,0	1,0	1,0	0,9	
	1,6	2,1	2,1	2,0	1,9	1,9	1,8	1,7	1,7	1,6	1,5	1,5	
	2	2,7	2,6	2,5	2,4	2,3	2,2	2,2	2,1	2,0	1,9	1,9	
	3	4,0	3,9	3,7	3,6	3,5	3,3	3,2	3,1	3,0	2,9	2,8	
	4	5,3	5,2	5,0	4,8	4,6	4,5	4,3	4,1	4,0	3,9	3,7	
	6	8,0	7,7	7,5	7,2	6,9	6,7	6,5	6,2	6,0	5,8	5,6	
	8	10,7	10,3	9,9	9,6	9,3	8,9	8,6	8,3	8,0	7,7	7,4	
	10	13,4	12,9	12,4	12,0	11,6	11,2	10,8	10,4	10,0	9,6	9,3	
	13	17,5	17,0	16,0	15,5	15,0	14,5	14,0	13,5	13,0	12,5	12,0	
	16	21,5	20,5	20,0	19,0	18,5	18,0	17,0	16,5	16,0	15,5	15,0	
20	26,5	26,0	25,0	24,0	23,0	22,5	21,5	20,5	20,0	19,5	18,5		
25	33,5	32,0	31,0	30,0	29,0	28,0	27,0	26,0	25,0	24,0	23,0		
32	43,0	41,5	40,0	38,5	37,0	35,5	34,5	33,0	32,0	31,0	29,5		
40	53,5	51,5	49,5	48,0	46,5	44,5	43,0	41,5	40,0	38,5	37,0		
50	67,0	64,5	62,0	60,0	58,0	56,0	54,0	52,0	50,0	48,0	46,5		
63	84,5	81,0	78,5	75,5	73,0	70,5	67,5	65,5	63,0	60,5	58,5		

MCBs technical details

Performances at different ambient temperatures, altitudes and frequencies

Derating of load capability of MCBs

Derating of MCBs load capability takes in consideration 2 factors: ambient temperature and influence of adjacent devices (see page 1/163). The rules to obtain the effective value of I_n are the following:

1. Deviating ambient temperature:

The rated value of the current of a miniature circuit-breaker refers to a temperature of 20 °C for circuit-breakers with characteristics K and Z and 30 °C for characteristics B, C and D. The following tables contain the derating of load

capability of **S 200/S 200 M/S 200 P/S 200 S MCBs*** with temperature from -40 °C to 70 °C for the curves B, C, D and K, Z.

Max. operating current depending on the ambient temperature of a circuit-breaker in load circuit of characteristics type B, C, D, K, Z.

Tripping characteristics	Rated current I_n A	Maximum operating current at ambient temperature											
		T °C											
		-40	-30	-20	-10	0	10	20	30	40	50	60	70
B, C and D ¹	0,5	0,6	0,6	0,6	0,6	0,5	0,5	0,5	0,5	0,5	0,5	0,5	0,4
	1	1,2	1,2	1,2	1,1	1,1	1,1	1,0	1	1,0	0,9	0,9	0,9
	1,6	1,9	1,9	1,8	1,8	1,7	1,7	1,6	1,6	1,6	1,5	1,5	1,4
	2	2,4	2,4	2,3	2,2	2,2	2,1	2,1	2	1,9	1,9	1,8	1,8
	3	3,6	3,5	3,5	3,4	3,3	3,2	3,1	3	2,9	2,8	2,7	2,6
	4	4,8	4,7	4,6	4,5	4,4	4,2	4,1	4	3,9	3,8	3,6	3,5
	6	7,3	7,1	6,9	6,7	6,5	6,4	6,2	6	5,8	5,6	5,5	5,3
	8	9,7	9,4	9,2	9,0	8,7	8,5	8,2	8	7,8	7,5	7,3	7,0
	10	12,1	11,8	11,5	11,2	10,9	10,6	10,3	10	9,7	9,4	9,1	8,8
	13	15,7	15,3	15,0	14,6	14,2	13,8	13,4	13	12,6	12,2	11,8	11,4
	16	19,4	18,9	18,4	17,9	17,4	17,0	16,5	16	15,5	15,0	14,6	14,1
	20	24,2	23,6	23,0	22,4	21,8	21,2	20,6	20	19,4	18,8	18,2	17,6
	25	30,3	29,5	28,8	28,0	27,3	26,5	25,8	25	24,3	23,5	22,8	22,0
	32	38,7	37,8	36,8	35,8	34,9	33,9	33,0	32	31,0	30,1	29,1	28,2
40	48,4	47,2	46,0	44,8	43,6	42,4	41,2	40	38,8	37,6	36,4	35,2	
50	60,5	59,0	57,5	56,0	54,5	53,0	51,5	50	48,5	47,0	45,5	44,0	
63	76,2	74,3	72,5	70,6	68,7	66,8	64,9	63	61,1	59,2	57,3	55,4	
K, Z	0,2	0,2	0,2	0,2	0,2	0,2	0,2	0,2	0,2	0,2	0,2	0,2	0,2
	0,3	0,4	0,4	0,3	0,3	0,3	0,3	0,3	0,3	0,3	0,3	0,3	0,2
	0,5	0,6	0,6	0,6	0,6	0,5	0,5	0,5	0,5	0,5	0,4	0,4	0,4
	0,75	0,9	0,9	0,9	0,8	0,8	0,8	0,75	0,7	0,7	0,7	0,6	0,6
	1	1,2	1,2	1,2	1,1	1,1	1,0	1	1,0	0,9	0,9	0,9	0,8
	1,6	2,0	1,9	1,9	1,8	1,7	1,7	1,6	1,5	1,5	1,4	1,4	1,3
	2	2,5	2,4	2,3	2,2	2,2	2,1	2	1,9	1,9	1,8	1,7	1,7
	3	3,7	3,6	3,5	3,3	3,2	3,1	3	2,9	2,8	2,7	2,6	2,5
	4	5,0	4,8	4,6	4,5	4,3	4,1	4	3,9	3,7	3,6	3,4	3,3
	6	7,5	7,2	6,9	6,7	6,5	6,2	6	5,8	5,6	5,4	5,2	5,0
	8	9,9	9,6	9,3	8,9	8,6	8,3	8	7,7	7,4	7,1	6,9	6,6
	10	12,4	12,0	11,6	11,2	10,8	10,4	10	9,6	9,3	8,9	8,6	8,3
	13	16,2	15,6	15,0	14,5	14,0	13,5	13	12,5	12,1	11,6	11,2	10,8
	16	19,9	19,2	18,5	17,8	17,2	16,6	16	15,4	14,8	14,3	13,8	13,3
	20	24,9	24,0	23,1	22,3	21,5	20,7	20	19,3	18,5	17,9	17,2	16,6
	25	31,1	30,0	28,9	27,9	26,9	25,9	25	24,1	23,2	22,3	21,5	20,7
32	39,8	38,4	37,0	35,7	34,4	33,2	32	30,8	29,7	28,6	27,5	26,5	
40	49,7	48,0	46,3	44,6	43,0	41,5	40	38,5	37,1	35,7	34,4	33,1	
50	62,2	60,0	57,8	55,8	53,8	51,9	50	48,2	46,4	44,7	43,0	41,4	
63	78,3	75,5	72,9	70,3	67,7	65,3	63	60,7	58,4	56,3	54,2	52,2	

1) For dedicated availability, see catalogue

MCBs technical details

Performances at different ambient temperatures, altitudes and frequencies

SU200 M - IEC/EN 60947-2

I _n (A)	Ambient temperature T (°C)											
	-40	-30	-20	-10	0	10	25	30	40	50	60	70
0.2 ¹⁾	0.26	0.25	0.24	0.23	0.22	0.22	0.21	0.20	0.19	0.19	0.18	0.17
0.3 ¹⁾	0.39	0.37	0.36	0.35	0.33	0.32	0.31	0.30	0.29	0.28	0.27	0.26
0.5	0.64	0.62	0.60	0.58	0.56	0.54	0.52	0.5	0.48	0.46	0.45	0.43
0.75 ¹⁾	0.97	0.93	0.90	0.87	0.84	0.81	0.78	0.75	0.72	0.70	0.67	0.65
1	1.29	1.24	1.20	1.16	1.12	1.08	1.04	1.00	0.96	0.93	0.89	0.86
1.6	2.06	1.99	1.92	1.85	1.78	1.72	1.66	1.6	1.54	1.48	1.43	1.38
2	2.58	2.49	2.40	2.31	2.23	2.15	2.07	2.00	1.93	1.85	1.79	1.72
3	3.87	3.73	3.60	3.47	3.35	3.23	3.11	3.00	2.89	2.78	2.68	2.58
4	5.16	4.97	4.80	4.63	4.46	4.30	4.15	4.00	3.85	3.71	3.57	3.44
5	6.45	6.22	6.00	5.78	5.58	5.38	5.19	5.00	4.82	4.64	4.47	4.30
6	7.74	7.46	7.20	6.94	6.69	6.45	6.22	6.00	5.78	5.56	5.36	5.16
8	10.32	9.95	9.59	9.25	8.92	8.60	8.30	8.00	7.70	7.42	7.14	6.88
10	12.90	12.44	11.99	11.56	11.15	10.75	10.37	10.00	9.63	9.27	8.93	8.60
13	16.76	16.17	15.59	15.03	14.50	13.98	13.48	13.00	12.52	12.06	11.61	11.18
15	19.34	18.65	17.99	17.35	16.73	16.13	15.56	15.00	14.45	13.91	13.40	12.90
16	20.63	19.90	19.19	18.50	17.84	17.21	16.59	16.00	15.41	14.84	14.29	13.76
20	25.79	24.87	23.98	23.13	22.30	21.51	20.74	20.00	19.26	18.55	17.86	17.20
25	32.24	31.09	29.98	28.91	27.88	26.88	25.93	25.00	24.08	23.18	22.33	21.50
30	38.69	37.31	35.98	34.69	33.45	32.26	31.11	30.00	28.89	27.82	26.79	25.80
32	41.27	39.79	38.37	37.01	35.69	34.41	33.18	32.00	30.82	29.68	28.58	27.52
35	45.14	43.53	41.97	40.47	39.03	37.64	36.30	35.00	33.71	32.46	31.26	30.10
40	51.58	49.74	47.97	46.26	44.61	43.01	41.48	40.00	38.52	37.09	35.72	34.40
50	64.48	62.18	59.96	57.82	55.76	53.77	51.85	50.00	48.15	46.37	44.65	43.00
60	77.38	74.61	71.95	69.39	66.91	64.52	62.22	60.00	57.78	55.64	53.58	51.60
63	81.24	78.35	75.55	72.85	70.25	67.75	65.33	63.00	61.00	58.00	56.00	54.00

1) Current ratings 0.2, 0.3 and 0.75 A available with K characteristic only

MCBs technical details

Performances at different ambient temperatures, altitudes and frequencies

SU200 M - UL 489

I_n (A)	Ambient temperature T (°C)											
	-40	-30	-20	-10	0	10	25	30	40	50	60	70
0.2 ¹⁾	0.27	0.26	0.25	0.24	0.23	0.22	0.22	0.21	0.20	0.19	0.19	0.18
0.3 ¹⁾	0.40	0.39	0.37	0.36	0.35	0.33	0.32	0.31	0.30	0.29	0.28	0.27
0.5	0.67	0.64	0.62	0.60	0.58	0.56	0.54	0.52	0.50	0.48	0.46	0.45
0.75 ¹⁾	1.00	0.97	0.93	0.90	0.87	0.84	0.81	0.78	0.75	0.72	0.70	0.67
1	1.34	1.29	1.24	1.20	1.16	1.12	1.08	1.04	1.00	0.96	0.93	0.89
1.6	2.14	2.06	1.99	1.92	1.85	1.78	1.72	1.66	1.6	1.54	1.48	1.43
2	2.67	2.58	2.49	2.40	2.31	2.23	2.15	2.07	2.00	1.93	1.85	1.79
3	4.01	3.87	3.73	3.60	3.47	3.35	3.23	3.11	3.00	2.89	2.78	2.68
4	5.35	5.16	4.97	4.80	4.63	4.46	4.30	4.15	4.00	3.85	3.71	3.57
5	6.69	6.45	6.22	6.00	5.78	5.58	5.38	5.19	5.00	4.82	4.64	4.47
6	8.02	7.74	7.46	7.20	6.94	6.69	6.45	6.22	6.00	5.78	5.56	5.36
8	10.70	10.32	9.95	9.59	9.25	8.92	8.60	8.30	8.00	7.70	7.42	7.14
10	13.37	12.90	12.44	11.99	11.56	11.15	10.75	10.37	10.00	9.63	9.27	8.93
13	17.38	16.76	16.17	15.59	15.03	14.50	13.98	13.48	13.00	12.52	12.06	11.61
15	20.06	19.34	18.65	17.99	17.35	16.73	16.13	15.56	15.00	14.45	13.91	13.40
16	21.40	20.63	19.90	19.19	18.50	17.84	17.21	16.59	16.00	15.41	14.84	14.29
20	26.75	25.79	24.87	23.98	23.13	22.30	21.51	20.74	20.00	19.26	18.55	17.86
25	33.43	32.24	31.09	29.98	28.91	27.88	26.88	25.93	25.00	24.08	23.18	22.33
30	40.12	38.69	37.31	35.98	34.69	33.45	32.26	31.11	30.00	28.89	27.82	26.79
32	42.79	41.27	39.79	38.37	37.01	35.69	34.41	33.18	32.00	30.82	29.68	28.58
35	46.81	45.14	43.53	41.97	40.47	39.03	37.64	36.30	35.00	33.71	32.46	31.26
40	53.49	51.58	49.74	47.97	46.26	44.61	43.01	41.48	40.00	38.52	37.09	35.72
50	66.87	64.48	62.18	59.96	57.82	55.76	53.77	51.85	50.00	48.15	46.37	44.65
60	80.24	77.38	74.61	71.95	69.39	66.91	64.52	62.22	60.00	57.78	55.64	53.58
63	84.25	81.24	78.35	75.55	72.85	70.25	67.75	65.33	63.00	60.67	58.42	56.26

1) Current ratings 0.2, 0.3 and 0.75 A available with K characteristic only

S200 80-100A

I_n (A)	Ambient temperature T (°C)											
	-40	-30	-20	-10	0	10	25	30	40	50	60	70
80	96.8	94.4	92.0	89.6	87.2	84.8	82.4	80.0	77.6	75.2	72.8	70.4
100	121.0	118.0	115.0	112.0	109.0	106.0	103.0	100.0	97.0	94.0	91.0	88.0

SN201

I_n (A)	Ambient temperature T (°C)									
	-25	-20	-10	0	10	20	30	40	50	55
2	2.37	2.32	2.26	2.18	2.12	2.06	2.00	1.95	1.91	1.89
4	4.74	4.60	4.53	4.37	4.24	4.12	4.00	3.90	3.85	3.79
6	7.20	7.00	6.80	6.40	6.30	6.20	6.00	5.90	5.80	5.70
10	11.80	11.60	11.30	10.90	10.60	10.30	10.00	9.80	9.70	9.50
16	18.10	17.70	17.40	16.90	16.60	16.30	16.00	15.80	15.70	15.50
20	23.70	23.20	22.60	21.80	21.20	20.60	20.00	19.60	19.10	18.90
25	29.40	29.00	28.20	27.40	26.70	26.00	25.00	24.20	23.50	23.10
32	38.70	38.10	37.20	36.20	34.60	33.00	32.00	31.30	30.50	30.00
40	48.30	47.50	45.80	44.40	42.70	41.00	40.00	39.50	38.60	38.20

MCBs technical details

Performances at different ambient temperatures, altitudes and frequencies

S 750 DR

$E_{\text{selective}}$	Maximum operating current at ambient temperature T (°C)								
Rated current I_n (A)	-20	-10	0	10	20	30	40	50	
16	21.4	20.4	19.3	18.2	17.1	16.0	15.2	14.4	
20	26.8	25.4	24.1	22.7	21.4	20.0	19.0	18.0	
25	33.5	31.8	30.1	28.4	26.7	25.0	23.8	22.5	
32	42.9	40.7	38.5	36.4	34.2	32.0	30.4	28.8	
40	53.6	50.9	48.2	45.4	42.7	40.0	38.0	36.0	
50	67.0	63.6	60.2	56.8	53.4	50.0	47.5	45.1	
63	84.5	80.2	75.9	71.6	67.3	63.0	59.9	56.8	
80	107.2	101.8	96.3	90.9	85.4	80.0	76.0	72.1	
100	134.1	127.2	120.4	113.6	106.8	100.0	95.1	90.1	

$K_{\text{selective}}$	Maximum operating current at ambient temperature T (°C)								
Rated current I_n (A)	-20	-10	0	10	20	30	40	50	
16	21.4	20.4	19.3	18.2	17.1	16.0	15.2	14.4	
20	26.8	25.4	24.1	22.7	21.4	20.0	19.0	18.0	
25	33.5	31.8	30.1	28.4	26.7	25.0	23.8	22.5	
32	42.9	40.7	38.5	36.4	34.2	32.0	30.4	28.8	
40	53.6	50.9	48.2	45.4	42.7	40.0	38.0	36.0	
50	67.0	63.6	60.2	56.8	53.4	50.0	47.5	45.1	
63	84.5	80.2	75.9	71.6	67.3	63.0	59.9	56.8	
80	107.2	101.8	96.3	90.9	85.4	80.0	76.0	72.1	
100	134.1	127.2	120.4	113.6	106.8	100.0	95.1	90.1	

DDA200 + S200, DS200 with B, C and D characteristics

Max. operating current depending on the ambient temperature of a circuit-breaker in load circuit.

B and C	Ambient temperature T (°C)									
I_n (A)	-25	-20	-10	0	10	20	30	40	50	55
0.5	0.64	0.62	0.60	0.58	0.55	0.53	0.50	0.47	0.44	0.43
1	1.27	1.25	1.20	1.15	1.11	1.05	1.00	0.94	0.88	0.85
1.6	2.04	2.00	1.92	1.85	1.77	1.69	1.60	1.51	1.41	1.36
2	2.54	2.49	2.40	2.31	2.21	2.11	2.00	1.89	1.76	1.70
3	3.80	3.70	3.60	3.50	3.30	3.20	3.00	2.80	2.60	2.50
4	5.10	5.00	4.80	4.60	4.40	4.20	4.00	3.80	3.50	3.40
6	7.60	7.50	7.20	6.90	6.60	6.30	6.00	5.70	5.30	5.10
8	10.15	10.00	9.60	9.20	8.80	8.40	8.00	7.50	7.10	6.80
10	12.70	12.50	12.00	11.50	11.10	10.50	10.00	9.40	8.80	8.50
13	16.50	16.20	15.60	15.00	14.40	13.70	13.00	12.30	11.50	11.10
16	20.40	20.00	19.20	18.50	17.70	16.90	16.00	15.10	14.10	13.60
20	25.40	24.90	24.00	23.10	22.10	21.10	20.00	18.90	17.60	17.00
25	31.80	31.20	30.00	28.90	27.60	26.40	25.00	23.60	22.00	21.20
32	40.60	39.90	38.50	37.00	35.40	33.70	32.00	30.20	28.20	27.20
40	50.80	49.90	48.10	46.20	44.20	42.20	40.00	37.70	35.30	34.00
50	63.50	62.40	60.10	57.70	55.30	52.70	50.00	47.10	44.10	42.50
63	80.00	78.60	75.70	72.70	69.60	66.40	63.00	59.40	55.60	53.50

MCBs technical details

Performances at different ambient temperatures, altitudes and frequencies

DDA200 + S200, DS200 (K and Z characteristics)

Max. operating current depending on the ambient temperature of a circuit-breaker in load circuit.

K and Z	Ambient temperature T (°C)										
	I_n (A)	-25	-20	-10	0	10	20	30	40	50	55
0,5		0.63	0.61	0.59	0.56	0.53	0.50	0.47	0.43	0.40	0.38
1		1.25	1.22	1.17	1.12	1.06	1.00	0.94	0.87	0.79	0.75
1,6		2.00	1.96	1.88	1.79	1.70	1.60	1.50	1.39	1.26	1.20
2		2.50	2.45	2.35	2.24	2.12	2.00	1.87	1.73	1.58	1.50
3		3.75	3.70	3.50	3.40	3.20	3.00	2.80	2.60	2.40	2.30
4		5.00	4.90	4.70	4.50	4.20	4.00	3.70	3.50	3.20	3.00
6		7.5	7.30	7.00	6.70	6.40	6.00	5.60	5.20	4.70	4.5
8		10.0	9.80	9.40	8.90	8.50	8.00	7.50	6.90	6.30	6.0
10		12.5	12.20	11.70	11.20	10.60	10.00	9.40	8.70	7.90	7.5
13		16.3	15.90	15.20	14.50	13.80	13.00	12.20	11.30	10.30	9.8
16		20.0	19.60	18.80	17.90	17.00	16.00	15.00	13.90	12.60	12.0
20		25.0	24.50	23.50	22.40	21.20	20.00	18.70	17.30	15.80	15.0
25		31.3	30.60	29.30	28.00	26.50	25.00	23.40	21.70	19.80	18.8
32		40.0	39.20	37.50	35.80	33.90	32.00	29.90	27.70	25.30	24.0
40		50.0	49.00	46.90	44.70	42.40	40.00	37.40	34.60	31.60	30.0
50		62.5	61.20	58.60	55.90	53.00	50.00	46.80	43.30	39.50	37.5
63		78.8	77.20	73.90	70.40	66.80	63.00	58.90	54.60	49.80	47.2

MCBs technical details

Performances at different ambient temperatures, altitudes and frequencies

Derating of load capacity of S800

The table refers to the product standard IEC 60947-2. These values are only valid if the circuit-breaker is mounted in free air according to the test conditions of the standard IEC 60 947-2.

The rated value of the current of the S800 refers to a calibration temperature of 30°C for characteristics B, C and D.

For characteristics K and UCK it refers to 40°C and the UL-version (S800U) refers to calibration temperature of 25°C.

Max. operating current depending on the ambient temperature of S800 with characteristics B, C, D, UCB.

B, C, Ambient temperature T (°C)																					
D, UCB																					
I_n (A)	-25	-20	-15	-10	-5	0	5	10	15	20	25	30	35	40	45	50	55	60	65	70	75
0,5	0,6	0,6	0,6	0,6	0,6	0,5	0,5	0,5	0,5	0,5	0,5	0,5	0,5	0,5	0,5	0,5	0,5	0,4	0,4	0,4	0,4
1	1,2	1,2	1,2	1,1	1,1	1,1	1,1	1,1	1	1	1	1	1	0,9	0,9	0,9	0,9	0,9	0,9	0,8	0,8
1,6	1,9	1,9	1,8	1,8	1,8	1,8	1,7	1,7	1,7	1,7	1,6	1,6	1,6	1,5	1,5	1,5	1,4	1,4	1,4	1,4	1,3
2	2,4	2,3	2,3	2,3	2,3	2,2	2,1	2,1	2,1	2,1	2	2	2	1,9	1,9	1,8	1,8	1,8	1,7	1,7	1,7
2,5	3	2,9	2,9	2,8	2,8	2,7	2,7	2,7	2,6	2,6	2,5	2,5	2,5	2,4	2,4	2,3	2,3	2,2	2,2	2,1	2,1
3	3,6	3,5	3,5	3,4	3,4	3,3	3,2	3,2	3,1	3,1	3	3	2,9	2,9	2,8	2,8	2,7	2,7	2,6	2,6	2,5
4	4,8	4,7	4,6	4,5	4,5	4,4	4,3	4,3	4,2	4,1	3,1	4	3,9	3,8	3,8	3,7	3,6	3,5	3,5	3,4	3,3
5	6	5,9	5,8	5,7	5,6	5,5	5,4	5,3	5,2	5,2	5,1	5	4,9	4,8	4,7	4,6	4,5	4,4	4,3	4,3	4,2
6	7,2	7,1	7	6,9	6,8	6,7	6,6	6,4	6,3	6,2	6,1	6	5,9	5,8	5,7	5,6	5,4	5,3	5,2	5,1	5
8	9,6	9,5	9,3	9,2	9	8,9	8,7	8,6	8,4	8,3	8,1	8	7,9	7,7	7,6	7,4	7,3	7,1	7	6,8	6,7
10	12	11,8	11,7	11,5	11,3	11,1	10,9	10,7	10,6	10,4	10,2	10	9,8	9,6	9,4	9,3	9,1	8,9	8,7	8,5	8,3
13	15,5	15,5	15	15	14,5	14,5	14	14	13,5	13,5	13	13	13	12,5	12,5	12	12	11,5	11,5	11	11
16	19	19	18,5	18,5	18	18	17,5	17	17	16,5	16,5	16	16	15,5	15	15	14,5	14	14	13,5	13,5
20	24	23,5	23,5	23	22,5	22	22	21,5	21	20,5	20,5	20	20	19,5	19	18,5	18	18	17,5	17	16,5
25	30	29,5	29	28,5	28	28	27,5	27	26,5	26	25,5	25	25	24	23,5	23	22,5	22	22	21,5	21
32	38,5	38	37,5	36,5	36	35,5	35	34,5	34	33	32,5	32	32	31	30	29,5	29	28,5	28	27,5	26,5
40	48	47,5	46,5	46	45	44,5	43,5	43	42	41,5	40,5	40	40	38,5	38	37	36,5	35,5	35	34	33,5
50	60	59	58,5	57,5	56,5	55,5	54,5	53,5	53	52	51	50	50	48	47	46,5	45,5	44,5	43,5	42,5	41,5
63	75,5	74,5	73,5	72	71	70	69	67,5	66,5	65,5	64	63	63	60,5	59,5	58,5	57	56	55	54	52,5
80	96	95	93	92	90	89	87	86	84	83	82	80	80	77	76	74	73	71	70	68	67
100	120	118	116	115	113	111	109	107	106	104	102	100	98	96	94	93	91	89	87	85	84
125	150	148	146	143	141	139	137	134	132	130	127	125	123	120	118	116	114	111	109	107	104

Max. operating current depending on the ambient temperature of S800 with characteristic K, UCK, PV-SP (from 5 A)

K, Ambient temperature (°C)																					
UCK, PV-SP																					
I_n [A]	-25	-20	-15	-10	-5	0	5	10	15	20	25	30	35	40	45	50	55	60	65	70	75
0,5	0,6	0,6	0,6	0,6	0,6	0,5	0,5	0,5	0,5	0,5	0,5	0,5	0,5	0,5	0,5	0,5	0,5	0,5	0,4	0,4	0,4
1	1,2	1,2	1,2	1,2	1,2	1,1	1,1	1,1	1,1	1,1	1	1	1	1	1	1	0,9	0,9	0,9	0,9	0,9
1,6	2	1,9	1,9	1,9	1,8	1,8	1,8	1,8	1,7	1,7	1,7	1,7	1,6	1,6	1,6	1,5	1,5	1,5	1,4	1,4	1,4
2	2,5	2,4	2,4	2,3	2,3	2,3	2,2	2,2	2,2	2,1	2,1	2,1	2	2	2	1,9	1,9	1,8	1,8	1,8	1,7
2,5	3,1	3	3	2,9	2,9	2,8	2,8	2,7	2,7	2,7	2,6	2,6	2,5	2,5	2,5	2,4	2,4	2,3	2,3	2,2	2,2
3	3,7	3,6	3,6	3,5	3,5	3,4	3,4	3,3	3,2	3,2	3,1	3,1	3	3	2,9	2,9	2,8	2,8	2,7	2,7	2,6
4	4,9	4,8	4,8	4,7	4,6	4,5	4,5	4,4	4,3	4,3	4,2	4,1	4,1	4	3,9	3,8	3,8	3,7	3,6	3,5	3,5
5	6,1	6	6	5,9	5,8	5,7	5,6	5,5	5,4	5,3	5,2	5,2	5,1	5	4,9	4,8	4,7	4,6	4,5	4,4	4,3
6	7,4	7,3	7,2	7,1	7	6,9	6,8	6,7	6,6	6,4	6,3	6,2	6,1	6	5,9	5,8	5,7	5,6	5,5	5,3	5,2
8	9,9	9,8	9,6	9,5	9,3	9,2	9	8,9	8,7	8,6	8,4	8,3	8,2	8	7,9	7,7	7,6	7,4	7,3	7,1	7
10	12,4	12,2	12	11,8	11,7	11,5	11,3	11,1	10,9	10,7	10,6	10,4	10,2	10	9,8	9,6	9,4	9,3	9,1	8,9	8,7
13	16,1	15,9	15,6	15,4	15,1	14,9	14,7	14,4	14,2	14	13,7	13,5	13,2	13	12,8	12,5	12,3	12	11,8	11,6	11,3
16	20	19,5	19	19	18,5	18,5	18	18	17,5	17	17	16,5	16,5	16	15,5	15,5	15	15	14,5	14	14
20	25	24,5	24	23,5	23,5	23	22,5	22	22	21,5	21	20,5	20,5	20	19,5	19,5	19	18,5	18	18	17,5
25	31	30,5	30	29,5	29	28,5	28	28	27,5	27	26,5	26	25,5	25	24,5	24	23,5	23	22,5	22	22
32	39,5	39	38,5	38	37,5	36,5	36	35,5	35	34,5	34	33	32,5	32	31,5	31	30	29,5	29	28,5	28
40	49,5	49	48	47,5	46,5	46	45	44,5	43,5	43	42	41,5	40,5	40	39,5	38,5	38	37	36,5	35,5	35
50	62	61	60	59	58,5	57,5	56,5	55,5	54,5	53,5	53	52	51	50	49	48	47	46,5	45,5	44,5	43,5
63	78	77	75,5	74,5	73,5	72	71	70	69	67,5	66,5	65,5	64	63	62	60,5	59,5	58,5	57	56	55
80	99	98	96	95	93	92	90	89	87	86	84	83	82	80	79	77	76	74	72	71	70
100	124	122	120	118	117	115	113	111	109	107	106	104	102	100	98	96	95	93	91	89	87
125	155	153	150	148	146	143	141	139	137	134	132	130	127	125	123	120	118	116	114	111	109

MCBs technical details

Performances at different ambient temperatures, altitudes and frequencies

Max. operating current depending on the ambient temperature of S800U

U-K, Z, UCZ	Ambient temperature T (°C)																				
I _n (A)	-25	-20	-15	-10	-5	0	5	10	15	20	25	30	35	40	45	50	55	60	65	70	75
10	11,8	11,7	11,5	11,3	11,1	10,9	10,7	10,6	10,4	10,2	10	9,8	9,6	10	9,3	9,1	8,9	8,7	8,5	8,3	8,2
13	15,4	15,1	14,9	14,7	14,4	14,2	14	13,7	13,5	13,2	13	12,8	12,5	13	12	11,8	11,6	11,3	11,1	10,9	10,6
16	19	18,5	18,5	18	18	17,5	17	17	16,5	16,5	16	15,5	15,5	16	15	14,5	14	14	13,5	13,5	13
20	23,5	23,5	23	22,5	22	22	21,5	21	20,5	20,5	20	19,5	19,5	20	18,5	18	18	17,5	17	16,5	16,5
25	29,5	29	28,5	28	28	27,5	27	26,5	26	25,5	25	24,5	24	25	23	22,5	22	22	21,5	21	20,5
32	38	37,5	36,5	36	35,5	35	34,5	34	33	32,5	32	31,5	31	32	29,5	29	28,5	28	27,5	26,5	26
40	47,5	46,5	46	45	44,5	43,5	43	42	41,5	40,5	40	39,5	38,5	40	37	36,5	35,5	35	34	33,5	32,5
50	59	58,5	57,5	56,5	55,5	54,5	53,5	53	52	51	50	49	48	50	46,5	45,5	44,5	43,5	42,5	41,5	41
63	74,5	73,5	72	71	70	69	67,5	66,5	65,5	64	63	62	60,5	63	58,5	57	56	55	54	52,5	51,5
80	95	93	92	90	89	87	86	84	83	82	84	79	77	76	74	73	71	70	68	67	65
100	118	117	115	113	111	109	107	106	104	102	100	98	96	95	93	91	89	87	85	84	82

Max. operating current depending on the ambient temperature of S804U - PVSP5, - PVS5

- PVSP5, - PVS5	Ambient temperature T (°C)																			
I _n (A)	-25	-20	-15	-10	-5	0	5	10	15	20	25	30	35	40	45	50	55	60	65	70
5	6,50	6,40	6,30	6,20	6,10	6,00	5,90	5,80	5,70	5,60	5,50	5,40	5,30	5,2	5,10	5,00	4,90	4,80	4,70	4,60

Influence of mounting distances between the devices

Multiply the rated current referring to your max. occurrent temperature with the factor of "influence of mounting distances".

Example: 2 x S802B-B125 at T = 40 °C with distance

$$I_n = 120.4 \text{ A} \times 92.1 \% = 110.9 \text{ A}$$

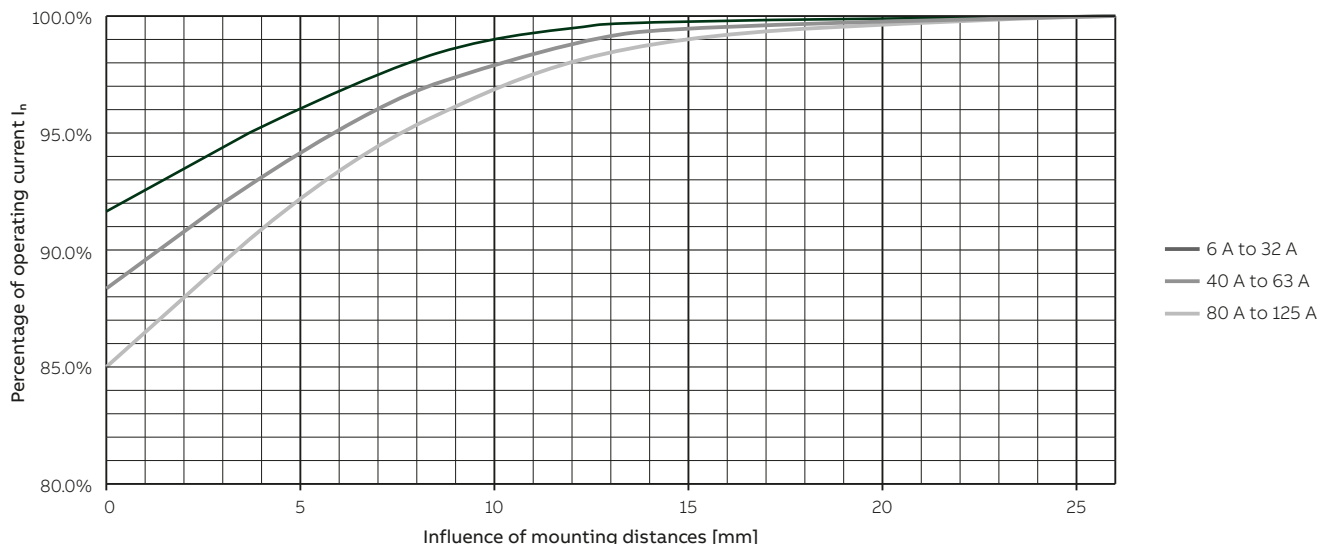

Further influencing factors, which can lead to a reduction of the maximum operating current, are:

- Shortening the cable length compared to IEC 60947-1/2
- Reducing the cable cross section compared to IEC 60947-1/2
- Accumulation of cables

MCBs technical details

Performances at different ambient temperatures, altitudes and frequencies

2. Multiply the rated current (equivalent) referring to the new temperature by another factor only in case of presence of several devices installed alongside each other; see table.

Example: S 202 C 16 with T=40 °C

Type of use	Values to use	Formula	Calculation	Result
Load at ambient temperature	I_n (amb. t°) -see tables-			$I_n=15.5$ A
Load at ambient temperature with 8 adj. devices	I_n (amb. t°) -see tables- Fm (0.77)	I_n (amb. t°)x0.77	15.5x0.77	$I_n=11.94$ A

S200, DS200, DDA200+S200 Influence of adjacent devices Correction factor Fm

No. of adjacent devices	Fm
1	1
2	0.95
3	0.9
4	0.86
5	0.82
6	0.8
7	0.78
8	0.77
9	0.76
>9	0.76

S300 Influence of adjacent devices Correction factor Fm

No. of adjacent devices	Fm
1	1.00
2, 3	0.9
4, 5	0.8
≥ 6	0.75

SU200 M Influence of adjacent devices Correction factor Fm

No. of adjacent devices	Fm
1	1.00
2, 3	0.9
4, 5	0.8
> 6	0.75

Influent of adjacent devices for S200C series

Number of devices	K
2 or 3	0.9
4 or 5	0.8
6 to 9	0.7
> 10	0.6

No. of adjacent devices	Fm
1	1.00
2, 3	0.9
4, 5	0.8
> 6	0.75

SN201 Influence of adjacent devices Correction factor Fm

No. of adjacent devices	Fm
1	1.00
2	0.99
3	0.97
4	0.96
5	0.94
6	0.93
7	0.92
8	0.91
9	0.90
> 9	0.90

DS201 and DS202C Influence of adjacent devices Correction factor Fm

No. of adjacent devices	Fm
1	1.00
2	0.95
3	0.91
4	0.88
5	0.87
6	0.86
7	0.85
> 7	0.85

MCBs technical details

Use of MCBs in direct current circuits

Use of S 200/S 200 M/S 200 P miniature circuit-breakers in direct current circuits 72 VDC/125 VDC

In DC systems up to 72 VDC or, as the case may be, series connection up to 125 VDC, customary S 200/S 200 M series MCBs can be used. Polarity does not need to be taken into

consideration, the outgoing circuit may be implemented from above or below the device.

For higher direct voltage up to 440 VDC devices of the S 280 UC series must be used.

Example for max. permissible voltages between conductors depending on the number of poles and type of connection.

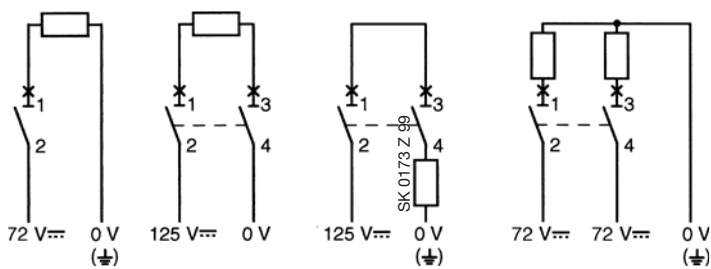

Examples for different voltages between a conductor and earth where voltages between conductors are identical:

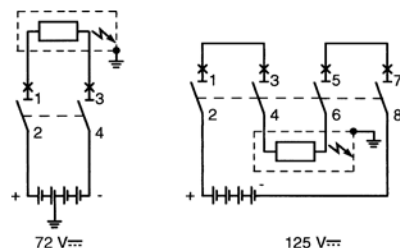

MCBs technical details

S 200 UDC series DC Applications

DC = Direct Current

S 200 UDC MCBs can be used in the one-pole version as 60 V DC (125 V DC up to 40 A), and in the 2-pole version with series connection of two poles up to 125 V DC (250 V DC up to 40 A).

S 200 UDC contains fitted permanent magnets, which assists in the forced extinguishing of the arc.

If voltages to earth exceeding 60 V DC may occur, 2-pole S 200 UDC is to be used for one-pole disconnection.

For DC incoming supply from above S 200 UDC-... MCBs have, in the area of arc chutes, permanent magnets, it is therefore necessary to take into account the polarity during the installation process.

Doing so ensures that in the case of a short circuit the magnetic field of the permanent magnets corresponds with the electromagnetic field of the short-circuit current, therefore safely leading the short circuit into the arc chute. Incorrect polarities may cause damage to the MCB. This is why – in the case of top-fed devices – terminal 1 must be connected to (-) and terminal to 3 (+).

Example for permissible voltages between the conductors depending on the number of poles and circuit layout:

voltage between conductors	U_n	60 V DC (125 V DC up to 40 A)	125 V DC (250 V DC up to 40 A)	125 V DC (250 V DC up to 40 A)	125 V DC (250 V DC up to 40 A)
voltage between conductor and earth	U_n	60 V DC (125 V DC up to 40 A)	60 V DC (125 V DC up to 40 A)	125 V DC (250 V DC up to 40 A)	60 V DC (125 V DC up to 40 A)
MCB		1-pole S 201 UDC	2-pole S 202 UDC	2-pole S 202 UDC	2-pole S 202 UDC

supply from below

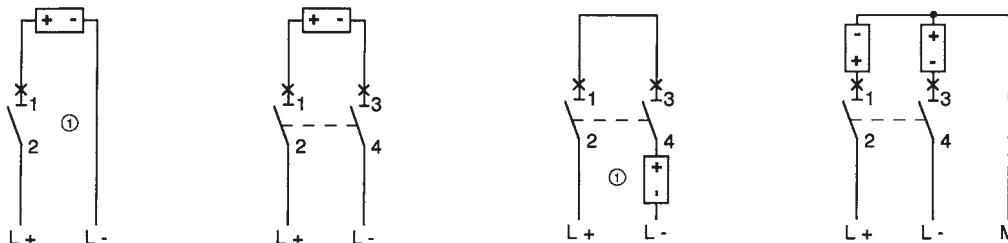

supply from above

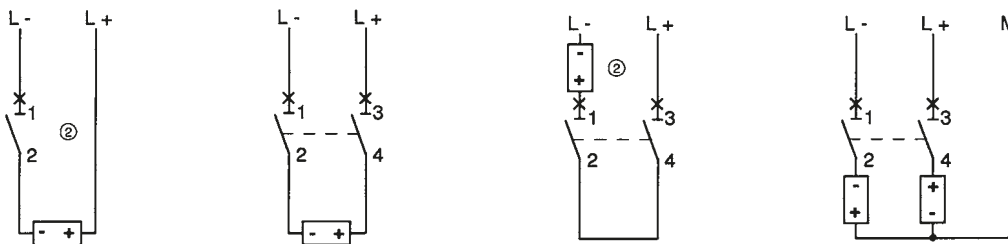

MCBs technical details

S 200 UDC series DC Applications

Examples for different voltage levels between conductor and earth in the case of identical voltage between conductors:

voltage between conductors	U_n	125 V– all-pole disconnection	125 V– 1-pole disconnection
voltage between conductor and earth	U_n	60 V– circuit symmetrically earthed	125 V– circuit unsymmetrically earthed
MCB		2-pole S 202 UDC	2-pole S 202 UDC

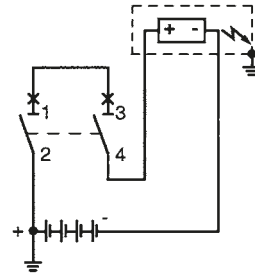
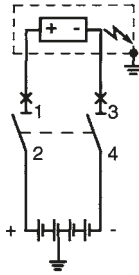

① in the circuit diagram, the negative pole is earthed.

② in the circuit diagram, the positive pole is earthed.

MCBs technical details

S 200 MUC series AC/DC Applications

UC = Universal Current = AC/DC

S 200 MUC MCBs can be used in the one-pole version as 220 V DC, and in the 2-pole or 4-pole version with series connection of two poles up to 440 V DC.

S 200 MUC contains fitted permanent magnets, which assists in the forced extinguishing of the arc.

If voltages to earth exceeding 220 V DC may occur, 2-pole S 200 MUC is to be used for one-pole disconnection, and four-pole S 200 MUC for all-pole disconnection.

For DC incoming supply from above S 200 MUC-... MCBs have, in the area of arc chutes, permanent magnets,

it is therefore necessary to take into account the polarity during the installation process.

Doing so ensures that in the case of a short circuit the magnetic field of the permanent magnets corresponds with the electromagnetic field of the short-circuit current, therefore safely leading the short circuit into the arc chute. Incorrect polarities may cause damage to the MCB. This is why – in the case of top-fed devices – terminal 1 must be connected to (-) and terminal to 3 (+).

Example for permissible voltages between the conductors depending on the number of poles and circuit layout:

voltage between conductors	U_n	220 V-	440 V-	440 V-	440 V-	440 V- (voltage reversal)
voltage between conductor and earth	U_n	220 V-	220 V-	440 V-	220 V-	220 V-
MCB		1-pole S 201 MUC	2-pole S 202 MUC	2-pole S 202 MUC	2-pole S 202 MUC	4-pole S 204 MUC
supply from below						
supply from above						

Examples for different voltage levels between conductor and earth in the case of identical voltage between conductors:

voltage between conductors	U_n	440 V- all-pole disconnection	440 V- 1-pole disconnection	440 V- all pole disconnection
voltage between conductor and earth	U_n	220 V- circuit symmetrically earthed	440 V- circuit unsymmetrically earthed	440 V- circuit unearthed or unsymmetrically earthed
MCB		2-pole S 202 MUC	2-pole S 202 MUC	4-pole S 204 MUC

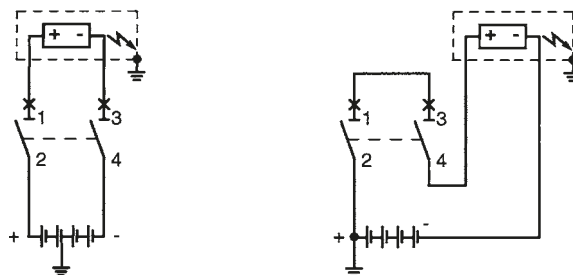

① in the circuit diagram, the negative pole is earthed. ② in the circuit diagram, the positive pole is earthed.

MCBs technical details

S800 series DC applications



S800S-UC: The first choice as DC high performance MCB

The S800S-UC DC high performance MCB is in a wide range of DC applications at home. Due to their high rated operational voltage of up to 1000VDC the max. rated current of 125 A and the high breaking capacity of up to 50 kA, make these devices suitable for applications, e.g.:

- DC track
- Galvanic applications
- Photovoltaics

S800S, N, and C: Up to 125 VDC on each pole

The AC range is also an interesting choice for DC applications up to 125VDC per pole.

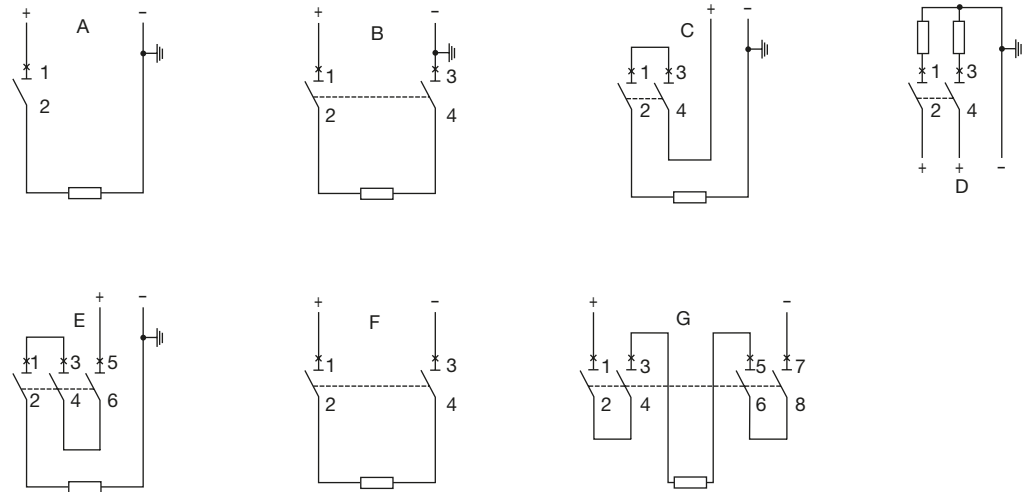

S800S-UC

Graphic	Short-circuit between output terminals	Contact to ground between output terminals and - earth
A	250 VDC	250 VDC
B	500 VDC	250 VDC
C	500 VDC	500 VDC
D	250 VDC	250 VDC
E	750 VDC	750 VDC
F	500 VDC	250 VDC (double failure)
G	750 V DC / 1000 V DC	500 VDC (double failure)

S800S, S800N, S800C

Graphic	Short-circuit between output terminals	Contact to ground between output terminals and - earth
A	125 VDC	125 VDC
B	250 VDC	125 VDC
C	250 VDC	250 VDC
D	125 VDC	125 VDC
E	375 VDC	375 VDC
F	250 VDC	125 VDC (double failure)
G	500 VDC	125 VDC (double failure)

MCBs technical details

S800 series DC applications



String protection with S800PV-SP

A large proportion of the costs for photovoltaic systems is tied up in the equipment for the DC generation. The S800PV-SP protects these investments in the event of a fault.

Convincing:	Suitable for up to 1500VDC
Loadable:	String protection up to 125 A Reliable protection at high ambient temperatures
Tested:	Rated ultimate short-circuit breaking capacity I_{cu} of 5kA in accordance with IEC 60947-2 and Annex P
Fast:	Reclosable for minimum standstill times
Safe:	Disconnecter properties, switching under load
Flexible:	Extensive range of accessories for remote shutdown and fault signalling



System isolation with S800PV-SD

The use of a DC isolator can be implemented reliably and in the minimum of space. Either you can choose the pole-independent S800PV-SD. The S800PV-SD is available as 2-,3- and 4-pole version up to 1500 V DC.

Convincing:	Suitable for up to 1500VDC
Loadable:	System isolation up to 125 A No change in operating behaviour up to 60°C ambient temperature Reliable switching of ohmic loads including moderate overloads
Compact:	Minimum dimensions with maximum efficiency
Tested:	Short-time withstand current I_{cw} of 1.5kA in accordance with IEC 60947-3
Safe:	Disconnecter properties, switching under load



Maximum device voltages

Article	2-pole	3-pole	4-pole
S800PV-SP			
I_e 5 ... 125A	800VDC	1200VDC	1500VDC
S800PV-SD			
I_e 32, 63, 125A	800VDC	1200VDC	1500VDC

ABB recommends to fulfill national and/or international standards as e.g. IEC 61439-1 Low-voltage switchgear and controlgear assemblies

Exemplary circuit diagrams

Earthed network

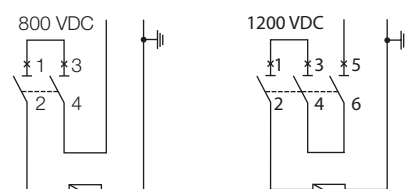

Non-earthed network

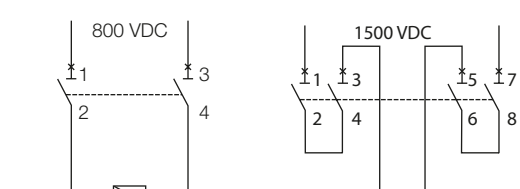

MCBs technical details

S800 series DC applications



GFDI = Ground Fault Detector Interrupter

The S804U-PVS5 is for GFDI application (Ground-Fault Detector Interrupter) in photovoltaic systems, with rated current 5 A and short-circuit current rating of 3 kA. The breaker is tested acc. to UL489B for 1000 VDC.

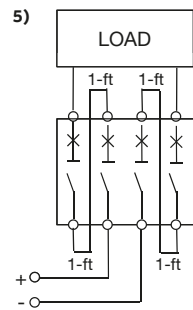
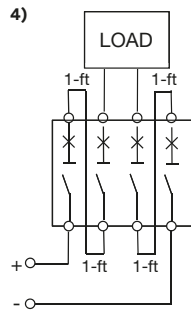
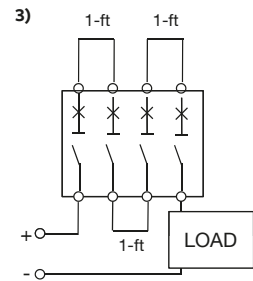
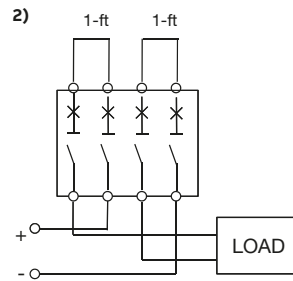
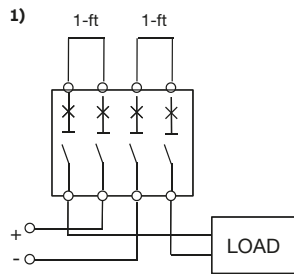

Wire size
14AWG — 2 AWG C_u,
solid or stranded

Conductor Type
Single conductor per terminal – copper only, 75C
wire

Line / load an +/- polarities may be reversed

Circuit 1, 2, 3, 4, 5 : ungrounded supplies
Circuit 3 : grounded supplies

MCBs technical details

Use of MCBs in altitude and different network frequency

Performance in altitude of MCBs

Up to the height of 2000 m, MCBs do not undergo any alterations in their rated performances. Over this height the properties of the atmosphere change in terms of composition, dielectric capacity, cooling capacity and

pressure, therefore the performances of the MCBs undergo derating, which can basically be measured in terms of variations in significant parameters, such as the maximum operating voltage and the rated current.

Miniature circuit breaker

Altitude	[m]	2000	3000	4000	5000
Rated voltage U_n		U_n	$0.887 \times U_n$	$0.775 \times U_n$	$0.676 \times U_n$
Rated current I_n		I_n	$0.96 \times I_n$	$0.93 \times I_n$	$0.90 \times I_n$

The derating of the rated voltage is valid for AC and DC voltages.

Variation of tripping thresholds of MCBs according to network frequency

The circuit-breakers are calibrated for a current with a frequency range between 50 and 60 Hz.

	AC			DC
	100 Hz	200 Hz	400 Hz	
Multiplier	1.1	1.2	1.5	1.5

The thermal tripping performance is independent from the network frequency.

Example:

S 202 C10 supplied at 50-60 Hz, the electro-magnetic tripping current is: $50 \text{ A} \leq I_m \leq 100 \text{ A}$;

S 202 C10 supplied at 400 Hz, the electro-magnetic tripping current is: $75 \text{ A} \leq I_m \leq 150 \text{ A}$.

MCBs technical details

Instruction for use of S 200 S

Connection and disconnection of different types of cables on the load side

Type of cables and cross sections

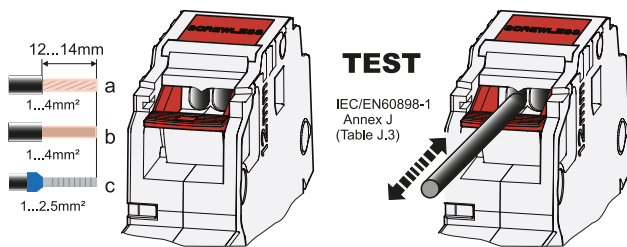

Connection of cables

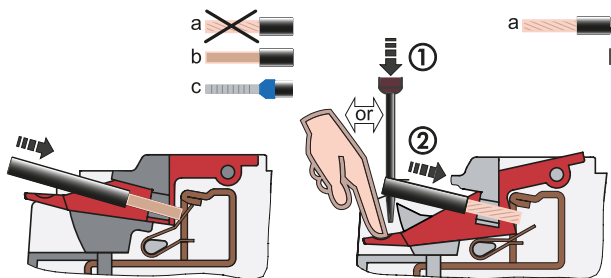

- Connection of one cable per opening.
- Rigid and flexible cables with end sleeves may be directly connected.
- If flexible cables without end sleeves are to be connected, the terminal must be opened. Splicing of the wires must be avoided.
- The cable must be inserted into the terminal either as far as possible or in such a way that a sufficient connection is obvious.
- The tightness of the connection must be checked.

Processing instructions

The screwless terminal at the load side of the S 200 S is designed so that copper cables basically may be connected without further preparation. If end sleeves are used as splicing protection for flexible cables, the compression of the end sleeves must comply with the pull-out forces in accordance with standard IEC/EN 60898-1 table J.3.

Recommended tools for flexible cables with end sleeves

Crimp tool with trapezoid compression profile

Disconnection of cables

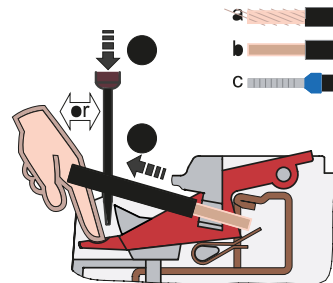

The cables may only be removed after operating the terminal's opening mechanism.

- If one cable is removed, the correct position of the remaining cable must be checked.

Wire stripping length / size of end sleeves for all cables

Wire stripping length and end sleeve length 12 (+2) mm

Distribution boards with metal cover

The distance from a metallic cover to the "shoulder" of the miniature circuit breaker must be at least 6 mm on the load side due to the arrangement of the easily accessible measurement point.

MCBs technical details

Particular supply sources and loads

Lighting circuit protection

Selection of circuit-breakers for the protection of lighting circuit and calculation of their rated current

To select the correct circuit-breaker for use in the protection of lighting circuits you need to know the type of load based on which you will work out the breaker's rated current. The protection circuit utilization current can be calculated simply starting with the rated power and the lighting voltage, or it

may be supplied directly by the device manufacturer.

Considering the utilization current, it is important to select the version of the breaker with a rated current just above the value calculated, defining the cable cross-section accordingly. The tables below show the rated current values of the circuit-breakers to be used according to the type and power of the device connected.

Table 1 High pressure discharge lamps

230 V and 400 V AC three-phase with or without power factor correcting capacitors, star or delta connection

Mercury vapour fluorescent lamp	Pw [W]	<700	<1000	<2000
	I [A]	6	10	16
Mercury vapour metal halogen lamp	Pw [W]	<375	<1000	<2000
	I [A]	6	10	16
High pressure sodium discharge lamp	Pw [W]	<400		<1000
	I [A]	6		16

Table 2 Fluorescent lamps

230 VAC single-phase/three-phase with neutral (400 V), with star connection.

The tables indicate the rated current of the circuit-breakers according to the lamp power and type of power supply.

Example of calculation

- Starter dissipated power: 25% of lamp power
- Reference temperature: 30 and 40 °C according to circuit-breaker
- Power factor: lamp without capacitors $\cos \phi = 0.6$
lamp with capacitors $\cos \phi = 0.86$

Method of calculation

- $IB = (PL * n^{\circ}L * KST * KC) / (Un * \cos \phi)$ where:
 - Un = rated voltage 230 V
 - $\cos \phi$ = power factor
 - PL = lamp power
 - $n^{\circ}L$ = number of lamps per phase
 - KST = 1.25
 - KC = 1 for star connection and 1.732 for delta connection

Type of lamp	Tube diss. pwr. [W]	Number of lamps per phase													
Single without capacitors	18	4	9	14	29	49	78	98	122	157	196	245	309	392	490
	36	2	4	7	14	24	39	49	61	78	98	122	154	196	245
	58	1	3	4	9	15	24	30	38	48	60	76	95	121	152
Single with capacitors	18	7	14	21	42	70	112	140	175	225	281	351	443	562	703
	36	3	7	10	21	35	56	70	87	112	140	175	221	281	351
	58	2	4	6	13	21	34	43	54	69	87	109	137	174	218
Double with capacitors	2x18=36	3	7	10	21	35	56	70	87	112	140	175	221	281	351
	2x36=72	1	3	5	10	17	28	35	43	56	70	87	110	140	175
	2x58=116	1	2	3	6	10	17	21	27	34	43	54	68	87	109
I_n [A] - 2P and 4P circuit-breakers		1	2	3	6	10	16	20	25	32	40	50	63	80	100

MCBs technical details

Particular supply sources and loads

Fluorescent lamps. 230 VAC three-phase – Delta connection

Type of lamp	Tube diss. pwr. [W]	Number of lamps per phase													
Single without capacitors	18	2	5	8	16	28	45	56	70	90	113	141	178	226	283
	36	1	2	4	8	14	22	28	35	45	56	70	89	113	141
	58	0	1	2	5	8	14	17	21	28	35	43	55	70	87
Single with capacitors	18	4	8	12	24	40	64	81	101	127	162	203	255	324	406
	36	2	4	6	12	20	32	40	50	64	81	101	127	162	203
	58	1	2	3	7	12	20	25	31	40	50	63	79	100	126
Double with capacitors	2x18=36	2	4	6	12	20	32	40	50	64	81	101	127	162	203
	2x36=72	1	2	3	6	10	16	20	25	32	40	50	63	81	101
	2x58=116	0	1	1	3	6	10	12	15	20	25	31	39	50	63
In [A] - 3P circuit-break.		1	2	3	6	10	16	20	25	32	40	50	63	80	100

Transformer protection

Insertion current

When the LV/LV transformers are powered up, very strong currents occur, which must be considered when selecting the protective device. The peak value of the first current wave often reaches a value between 10 and 15 times the transformer's effective rated current.

For power ratings below 50 kVA, it may reach between 20 and 25 times the rated current. This transient current decreases very rapidly with a time constant T varying from several ms to 10, 20 ms.

Main protection on the primary side

The tables below are the result of a set of tests on co-ordination between circuit-breakers and BT/BT transformers. The transformers used in the tests are normalized. The table, referring to a primary supply voltage of 230 or 400 V and to single-phase and three-phase transformers, indicate which circuit-breaker should be used according to the transformer power rating. The transformers considered have the primary winding outside the secondary winding.

The circuit-breakers suggested allow:

- transformer protection in the event of maximum short-circuit;
- prevention of unwanted tripping when the primary winding is powered up using
 1. modular circuit-breakers with a high magnetic threshold, curve D or K
 2. circuit-breakers with magnetic only releaser;
- guaranteed circuit-breaker electrical life.

Protection on the secondary side

Due to the transformer's high insertion current, the circuit-breaker on the primary winding may not guarantee thermal protection for the transformer and its feeder line on the primary side.

This is typical of modular circuit-breakers which must have a higher rated current than the transformers. In such cases, in the event of a single-phase short-circuit at the transformer's primary terminals (minimum I_{cc} at end of line), check that the circuit-breaker's magnetic releaser is tripped. In the normal application in distribution panels, this condition is always satisfied provided that the length of the feeder lines is reduced.

The transformer can be provided with thermal protection by installing a circuit-breaker with a rated current less than or equal to that of the transformer secondary winding immediately downstream of the LV/LV transformer.

In lighting systems protection against overloads is not necessary if the number of light points is clearly defined (no overloads).

Moreover, the Standard in force for these systems recommends the omission of protection against overloads in circuits in which unwanted tripping may prove hazardous, e.g.: circuits which supply fire-fighting equipment.

MCBs technical details

Particular supply sources and loads

Single-phase transformer (primary voltage 230 V)-1P and 1P+N MCBs

P_n [kVA]	I_n [A]	u_{cc} (%)	Circuit-breaker on primary side (1) and (2)
0.1	0.4	13	S 2* D1 o K1
0.16	0.7	10.5	S 2* D2 o K2
0.25	1.1	9.5	S 2* D3 o K3
0.4	1.7	7.5	S 2* D4 o K4
0.63	2.7	7	S 2* D6 o K6
1	4.2	5.2	S 2* D10 o K10
1.6	6.8	4	S 2* D16 o K16
2	8.4	2.9	S 2* D16 o K16
2.5	10.5	3	S 2* D20 o K20
4	16.9	2.1	S 2* D40 o K40
5	21.1	4.5	S 2* D50 o K50
6.3	27	4.5	S 2* D63 o K63

Single-phase transformer (primary voltage 400 V)-2P MCBs

P_n [kVA]	I_n [A]	u_{cc} (%)	Circuit-breaker on primary side (1) and (2)
1	2.44	8	S 2* D6 o K6
1.6	3.9	8	S 2* D10 o K10
2.5	6.1	3	S 2* D16 o K16
4	9.8	2.1	S 2* D20 o K20
5	12.2	4.5	S 2* D32 o K32
6.3	15.4	4.5	S 2* D40 o K40
8	19.5	5	S 2* D50 o K50
10	24	5	S 2* D63 o K63
12.5	30	5	S 2* D63 o K63

Three-phase transformer (primary voltage 400 V)-3P, 3P+N and 4P MCBs

P_n [kVA]	I_n [A]	u_{cc} (%)	Circuit-breaker on primary side (1) and (2)
5	7	4.5	S 2* D20 o K20
6.3	8.8	4.5	S 2* D20 o K20
8	11.6	4.5	S 2* D32 o K32
10	14	5.5	S 2* D32 o K32
12.5	17.6	5.5	S 2* D40 o K40
16	23	5.5	S 2* D63 o K63
20	28	5.5	S 2* D63 o K63

S 2*.. = S 200, S 200 M, S 200 P

- (1) With modular or magnetic only circuit-breakers, without thermal adjustment, thermal protection is required for the transformer's secondary winding.
 (2) Breaking capacity selected according to estimated I_{cc} at the point where the breaker is installed.

MCBs technical details

Particular supply sources and loads

Double tampoprinting of S 200 P

The breaking capacity

For the modular circuit-breakers realized according to IEC/EN 60898 standard, the breaking capacity is expressed by the I_{cn} quantity, indicated in Ampere, contained within a rectangle on the front side of the device. The max value of rated short-circuit capacity (I_{cn}) considered by this standard is 25000 A.

Always according to IEC/EN 60898 standard, the ratio between the service short-circuit capacity (I_{cs}) and the rated short-circuit capacity (I_{cn}) – K factor – shall have to be conforming to the enclosed table.

I_{cn}	K
< 6000 A	1
> 6000 A < 10000 A	0.75(*)
>10000 A	0.5(**)

(*) I_{cs} minimum value: 6000 A (**) I_{cs} minimum value: 7500 A

Limiting class

The Manufacturer of the circuit-breaker has the right to declare the energy limiting class of the device. According to IEC/EN 60898 standard, the Manufacturer classifies the circuit-breaker with a limiting class which ranges from 1 to

3 according to the I_2t values let though by the circuit-breaker for rated current up to 16 A and rated currents exceeding 16 A up to 32 A included, according to the table below.

Rated current up to 16 A:

Short-circuit rated capacity	Limited energy classes				
	1	2	3		
	I^2t max (A ² s)	I^2t max (A ² s)	I^2t max (A ² s)		
(A)	B-C Type	B Type	C Type	B Type	C Type
3000	No	31000	37000	15000	18000
4500	limits	60000	75000	25000	30000
6000	are	100000	120000	35000	42000
10000	specified	240000	290000	70000	84000

Rated current exceeding 16 A up to 32 A included:

Short-circuit rated capacity	Limited energy classes				
	1	2	3		
	I^2t max (A ² s)	I^2t max (A ² s)	I^2t max (A ² s)		
(A)	B-C Type	B Type	C Type	B Type	C Type
3000	No	40000	50000	18000	22000
4500	limits	80000	100000	32000	39000
6000	are	130000	160000	45000	55000
10000	specified	310000	370000	90000	110000

MCBs technical details

Particular supply sources and loads

For instance, a circuit-breaker with rated current 16 A, B characteristic, with short-circuit rated capacity equal to 6 kA belongs to class 3 if it lets through max 35000 A²s of specific energy.

The limiting class value (1, 2 or 3) is indicated on the front side of the device, within a square, in addition to the breaking capacity.

As regards the miniature circuit-breakers S200P series, two different breaking capacities are indicated on the front side of the device, contained in a rectangle.

The breaking capacity indicated above the operating toggle is the one of the device, according to IEC/EN 60898 standard, the breaking capacity indicated under the lever is regarding the limiting class which, according to the standard, can be expressed only for values up to 10000 A.

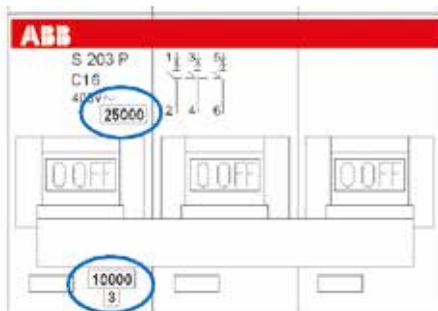

MCBs technical details

S800 range features



The S800S, -N, -C, -B and -HV high performance MCBs: safe innovation

The S800 high performance MCB limits energy and current in case of a short-circuit power cut off. The specially designed double arcing chamber system, i. e. per pole are two arcing chambers, ensures excellent operating characteristics. The new S800B has only one arcing chamber. Additional exceptional features of the S800 series are:

Convincing:	Selectivity to upstream overcurrent protection devices due to a total switch-off time of only ≤ 2.5 ms.
Safe:	Excellent backup protection by limiting the energy to a value $\leq 100\,000$ A ² s (125A/50kA). In case of short-circuit, there is a low load to the circuit and the location of the damage due to the high limitation of the let-through energy.
Loads:	Up to 125A rated current
Checked:	S series up to 50kA rated ultimate short-circuit breaking capacity I_{cu} N series up to 36kA rated ultimate short-circuit breaking capacity I_{cu} C series up to 25kA rated ultimate short-circuit breaking capacity I_{cu} B series up to 16kA rated ultimate short-circuit breaking capacity I_{cu} HV series up to 4kA rated ultimate short-circuit breaking capacity I_{cu}
Selectable:	Characteristics:
S series:	B, C, D, K, KM, UCB, UCK
N series:	B, C, D
C series:	B, C, D, K
B series:	B, C, D, K
HV series:	C, K
Compact:	Slight 27 mm width per pole
Flexible:	Accessories installed by the customer.



S800UP, -U, -U-UCZ, -U-PVS: Highest safety now also ensured for UL applications

Convincing:	Covering of different voltage ranges (240VAC, 480Y/277 V AC, 600VDC, 1000VDC)
Safe:	Excellent backup protection due to limitation of energy.
Loads:	Up to 100A rated current
Checked:	K-, Z series up to 50kA breaking capacity UCZ series up to 10kA breaking capacity PVS series up to 3kA breaking capacity
Selectable:	Characteristics: K, Z, UCZ, PVS
Compact:	Smallest sizes.
Flexible:	Accessories installed by the customer.
Standards:	UL489, UL489B, IEC 60947-2

Short description

Two triggers detect overcurrents, effect the switching station and provide short-circuit protection.

1. The thermal trip for overload protection with time delay.
2. The electromagnetic fast-acting trip with concrete anchor for short-circuit protection.

$I_k \times \sqrt{2}$	peak value of the prospective short-circuit current
i_D	max. let-through current of the S800 high performance MCB
U_n	supply voltage
U_B	build up and collapse of the arc voltage
t_k	Turn-off time of S800 high performance MCB

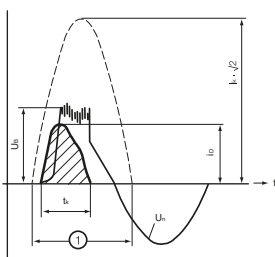

① 1 sinus half-wave
50 Hz Δ T/2 = 10 ms

MCBs technical details

S800 range features



Play it safe: display the operational state

The mechanical drive of the S800 high performance MCB is equipped with a trip-free release. It therefore switches independent of the actuating force or speed on the actuating lever.

The trip position display thereby always reliably displays the exact position of the moving contact. The trip position provides additional trip detection allowing you to easily find the reason for the cut-off. Because the switch lever moves to the middle position in case of thermal or magnetic tripping, the user sees at a glance that this is an error state and can then initiate suitable measures.

*Middle position of switch lever, see picture

Reliable: the disconnecter properties

In OFF position (0 position), the S800 high performance MCB guarantees safe electrical isolation of the circuit compliant to IEC 60947-2.

Flexible: the installation

The S800 high performance MCB can be directly mounted onto any position on the DIN mounting rail without any impairment to its characteristics. Because the pole dimensions are identical for all rated currents, installation in switching systems is simplified.

The S800 can be installed in different ways:

- together with other breakers in the same DIN rail horizontally or vertically
- as an individual breaker in a single fixed compartment where the breaker is switched on/off with a rotary handle from the door, and the breaker is mounted on the wall of the panel
- as an individual breaker in a single withdrawable module, when requirements for high availability in the installation are a must

Cage and ring terminals

When ordering you can choose between cage terminals or ring terminal connectors. No matter which type you select, both connection options guarantee a high degree of reliability.

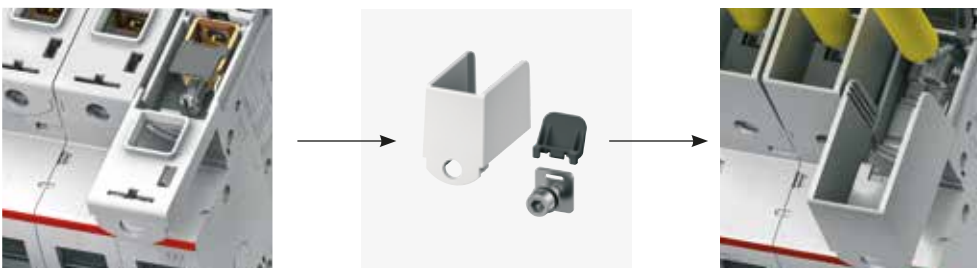

Doesn't let go: the replaceable terminal adapter*

The S800 standard equipment with interchangeable terminal adapter for wires, cables and rigid conductors guarantees a high level of flexibility and comfort. Fast and safe connection of the conductors is ensured by the "onboard terminal shutter" integrated into the body of the terminal, thereby preventing incorrect underclamping of the connections.

* Available for the S, N, C, U and PV series.

MCBs technical details

S800 range features



Extra safe: Fire protection acc. to NF F 16-101 and NF F 16-102 (prEN45545-2)

The S800 high performance MCB provides standard compliance to the requirements of Standard prEN45545-2 (Railway applications – Fire Protection on railway vehicles – Part 2: Requirements for fire behaviour of materials and components). This standard is based on the French standard NF F 16-101/ NF F 16-102 and makes new requirements of the fire behaviour of the materials used. The main focus of attention with relation to fire protection is on the following:

- Flame spread
- Rate of heat release
- Smoke development
- Toxicity

The S800 high performance automatic meets the following classification compliant to NF F 16-101 and NF F 16-102:

- I3F2
- I3 no permanent flame at 850°C
- F2 index of fume density and toxicity ≤ 40

More information regarding the use of S800 breakers in rolling stock applications is available in the Technical catalogue 'DIN-Rail components for rolling stock applications 2CDC002053D0204'

MCBs technical details

S800-SCL-SR range features

Group protection

The the main application of the S800S-SCL-SR is group protection. In comparison to other short-circuit limiter you need only one S800S-SCL-SR for several motor starters or high performance miniature circuit breakers. With the requirement that the rated current of the short-circuit limiter does not exceed the total sum of the rated S800S currents of all downstream motor starters or circuit breakers. Furthermore the sum of all load currents including inrush currents shall not exceed the maximum permissible load of the S800S-SCL-SR. Several downstream motor protection combinations or several high performance miniature circuit breakers can be protected with only one S800S-SCL-SR.

Current continuity

In case of a failure by using the S800-SCL-SR as group protection only the defective device will trip; all other devices will keep doing their work. Therefore you will have a very low breakdown, because only one motor will stop and not all of them.

Maximum system availability is given.

Schematic examples for rated currents up to 100 A

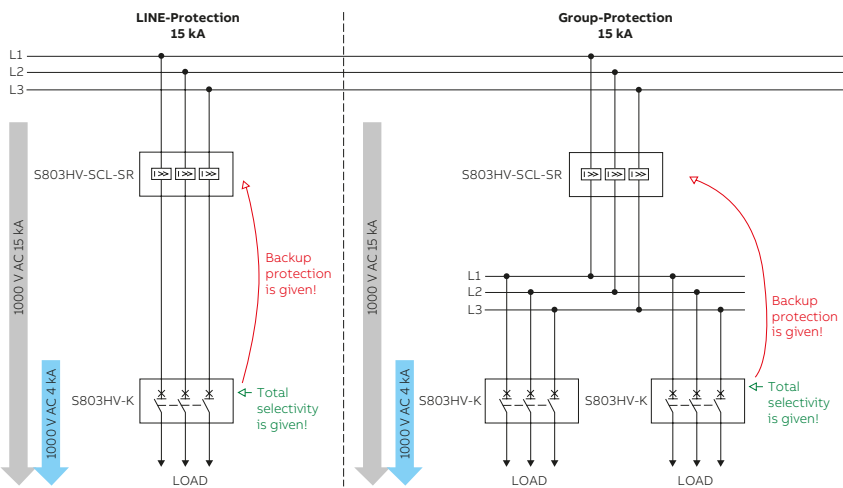
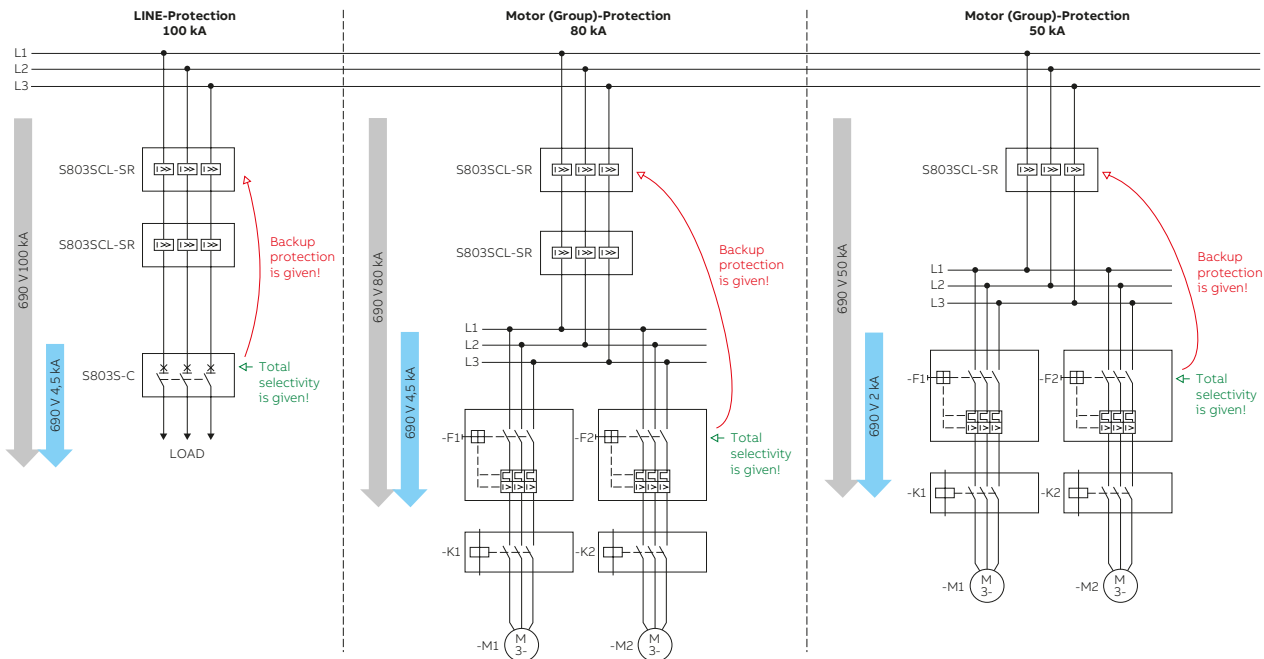

→ Short-circuit breaking capacity only downstream device
→ Short-circuit breaking capacity coordinated group S800-SCL-SR

MCBs technical details

S800-SCL-SR range features

S800-SCL-SR

Self-resetting short-circuit limiter

The S800-SCL-SR can be used together with S800S High Performance MCB or Manual Motor Starters. It limits the short-circuit current until the downstream means of protection trips. Its current continuity makes it as the ideal solution for group protection. All parallel branches remain operative.

Minimum cable length between S800-SCL-SR and downstream devices (Connection has to be shortcircuit proofed acc. to IEC 61439-1)

MS/M0325

MS/M0132

S800

S800-SCL-SR	min. length X	min. cross section
32 A	80 mm	6 mm ²
63 A	80 mm	16 mm ²
100/125 A	250 mm	35 mm ²

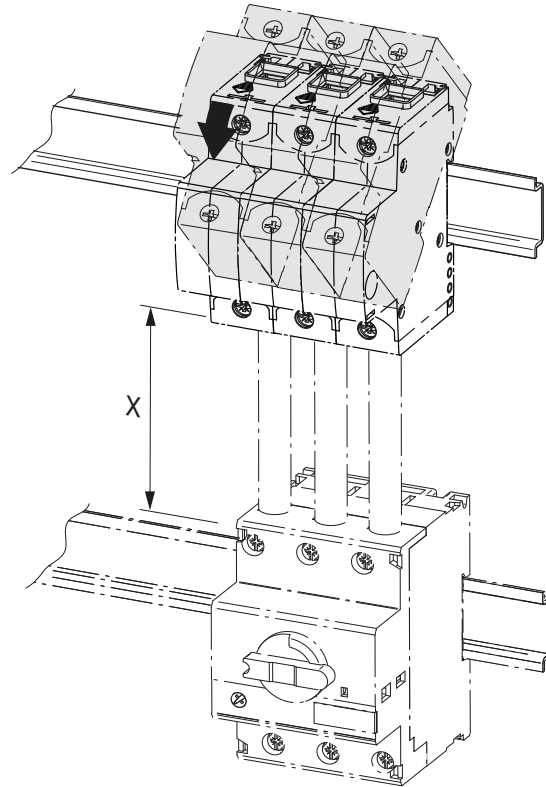

MCBs technical details

S800-SCL-SR range features

Approved combinations with high performance MCB S800

Downstream devices	Upstream devices		
	S800S-SCL-SR/S803W-SCL-SR Self resetting short-circuit limiter		
Rated current I _e [A]	32	63	100
S800S Characteristic B			
6	■		
8	■		
10	■	■	■
13	■	■	■
16	■	■	■
20	■	■	■
25	■	■	■
32	■	■	■
40		■	■
50		■	■
63		■	■
80			■
100			■
125			
S800S Characteristic C			
6	■		
8	■		
10	■	■	■
13	■	■	■
16	■	■	■
20	■	■	■
25	■	■	■
32		■	■
40		■	■
50		■	■
63			■
80			■
100			
125			
S800S Characteristic D/K			
6	■		
8	■		
10	■	■	■
13	■	■	■
16	■	■	■
20		■	■
25		■	■
32		■	■
40		■	■
50			■
63			
80			
100			
125			

MCBs technical details

S800-SCL-SR range features

Approved combinations with motor starter/S800S-KM

Downstream devices	Upstream devices		
	S800S-SCL-SR/S803W-SCL-SR Self resetting short-circuit limiter		
Rated current I_n [A]	32	63	100
MS/MO325			
0.1–2.5	■	■	■
4	■	■	■
6.3	■	■	■
9	■	■	■
12.5	■	■	■
16	■	■	■
20		■	■
25		■	■
MS/MO132			
0.1–2.5	■	■	
4	■	■	
6.3	■	■	■
10	■	■	■
16	■	■	■
20		■	■
25		■	■
32		■	■
S800S-KM			
20		■	■
25		■	■
32		■	■
40		■	■
50			■
63			■
80			

Approved combinations with S803HV-K

Downstream devices	Upstream devices S803HV-SCL-SR		
	Self resetting short-circuit limiter		
Rated operational current I_n [A]	32	63	100
6	■		
8	■		
10	■	■	■
13	■	■	■
16		■	■
20		■	■
25		■	■
32		■	■
40		■	■
50			■
63			■
80			
100			
125			

* Motor starter combinations acc. to IEC 60947-4-1

MCBs technical details

S800-SCL-SR range features

■ Applies for all voltages according to the table below

	S800S-SCL-SR	S803W-SCL-SR	S803HV-SCL-SR
Rated ultimate short-circuit breaking capacity			
$I_{cu} = I_{cs}$ according to IEC 60947-2			
(AC) 50/60 Hz 240/415 V	kA 100	100	
(AC) 50/60 Hz 254/440 V	kA 100	100	
(AC) 50/60 Hz 277/480 V	kA 65	65	
(AC) 50/60 Hz 289/500 V	kA 65	65	
(AC) 50/60 Hz 346/600 V	kA 65	65	
(AC) 50/60 Hz 400/690 V	kA 50	50	
(AC) 50/60 Hz 580/1000 V	kA		$I_{cu} = 15 \text{ kA}$ $I_{cs} = 10 \text{ kA}$
Short-circuit rating according to UL 508, CSA 22.2			
(AC) 50/60 Hz 480 V	kA	65	
(AC) 50/60 Hz 600 V	kA	65	

MCBs technical details

S800-SCL-SR range features

Internal resistance at 25 °C ambient temperature and nominal power losses

Rated operational current I_e	Internal resistance R_i	Power losses P_{vn}
[A]	[mΩ]	[W]
32	2.8	3.6
63	1.3	5.7
100	0.7	7.8

Influence of ambient temperature – single mounted devices

Rated operational current I_e [A]	10 °C	15 °C	20 °C	25 °C	30 °C	35 °C	40 °C	45 °C	50 °C	55 °C	60 °C	65 °C	70 °C
32	38.2	37.2	35.8	35.2	34.2	33.3	32	30.7	29.8	28.8	27.8	26.5	25.1
63	75.3	73.2	70.6	69.3	67.4	65.5	63	60.5	58.6	56.7	54.8	52.3	49.8
100	119.5	116.2	112	110	107	104	100	96	93	90	87	84	80

Installation requirements

The total sum of the rated currents of all downstream motor starters or circuit breakers shall not exceed the rated current of the S800-SCL-SR (valid also for HV version). Furthermore the sum of all load currents including inrush currents shall not exceed the maximum permissible load of the S800-SCL-SR (valid also for HV version).

Maximum load

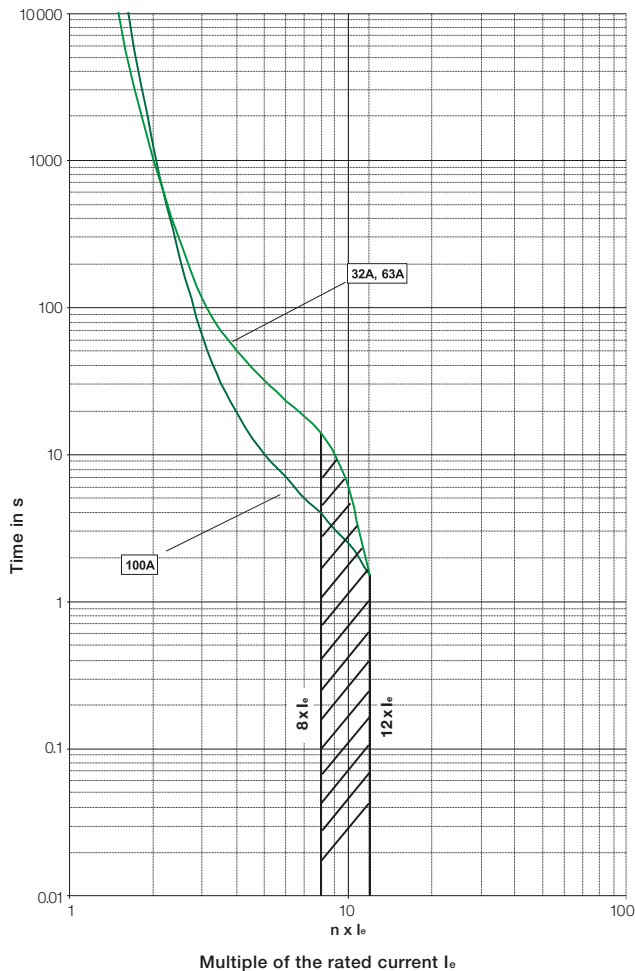

Example:

If you have 8 manual motor starters with each 5A as rated operational current

Sum: $8 \times 5A = 40A$

Then you have to use either the 63A or 100A S803-SCL-SR. In this example we use the 63A version.

We know that our maximum load is 245A. Thus we have to calculate if this maximum load can be handled with the 63A version and, if yes, for how many seconds.

$245A / 63A = 3.89 \sim 4$

So now you can check where the multiplier „4“ crosses the graph of the 63A version to know for how many seconds this load can be handled. In this example a load of 245 A can be handled for max. 50 seconds. Please note: always use the S800-SCL-SR in the left area of this graphic, since it would be damaged otherwise.

